

PRICE LIST

GBP RSP

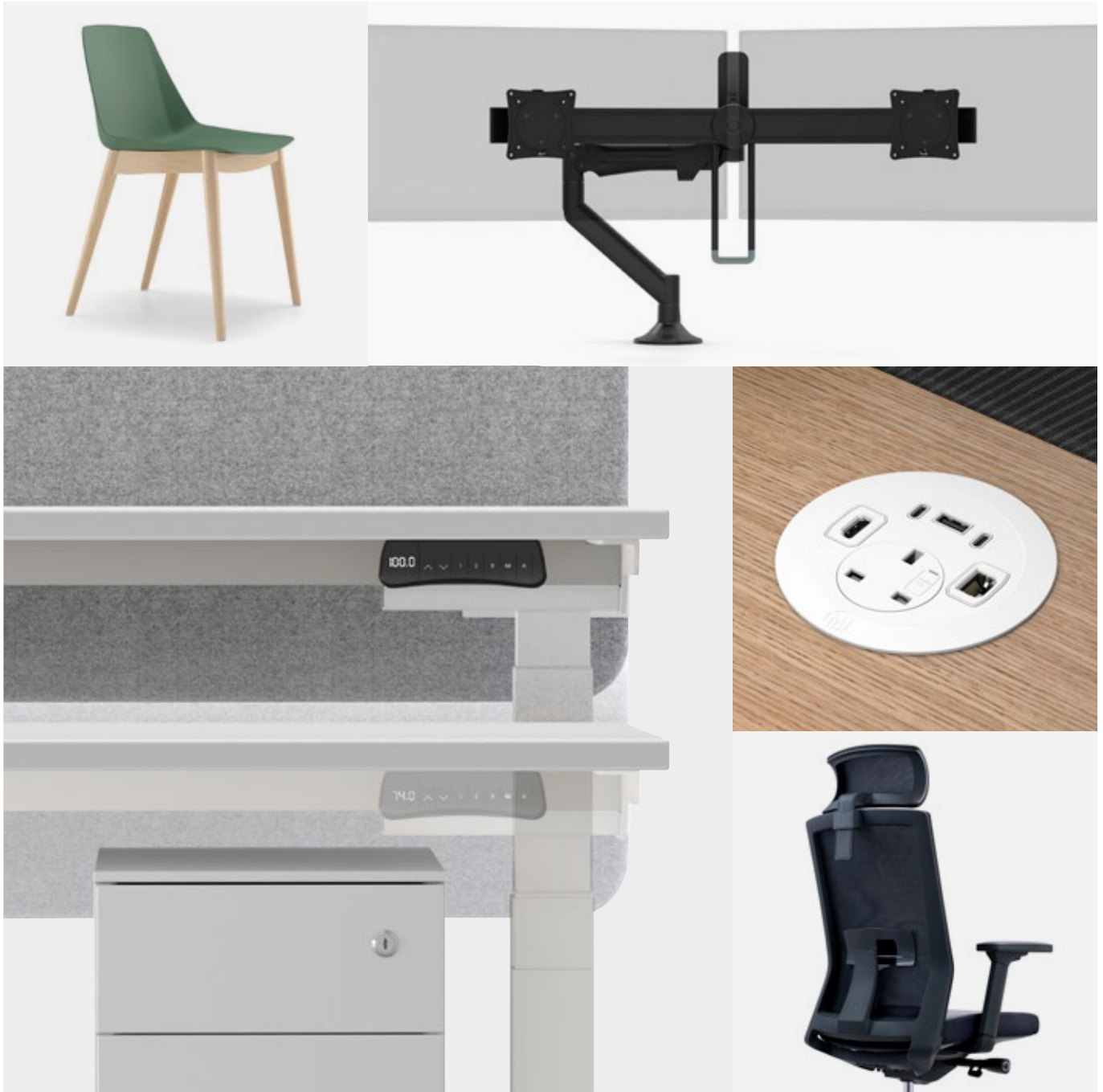

v7.2 Valid from 01/08/23



formetiq[®]
FORM. FUNCTION. INTELLIGENT DESIGN.

METALICON[®]
Dynamic. Expressive. Enduring.

narbutas

Contents

How to use our price list

At the start of each product range you'll find a grey **Materials** box outlining the available finishes, and the price bands they fit into.

Most product ranges are split into two or more price groups marked **G1, G2**, etc. You'll find a short breakdown of each price group in a grey box at the start of each list section.

Details and swatches for every finish and fabric can be found at the back of the price list.

Please note: not every colour from some fabric ranges is available on Narbutas products.

DESKING	6	TABLES	126
Nova Bench Desking	8	Nova Meeting Tables	128
Nova Wood Bench Desking	14	Nova Wood Meeting + Multipurpose Tables	132
Round Desking + Storage	20	Optima Meeting Tables	144
Optima Desks	38	Opto Conference Tables	148
Air Desks	44	T-Easy Meeting Tables	152
Alto Standing Desks + Benches	50	Forum Meeting Tables	154
Motion Sit/Stand Desks + Benches	54	Air Meeting Tables	158
MySpace Modular Workstations	308	Occasional Tables	160
RECEPTION FURNITURE	62	High Tables	164
Domino Reception Desks	64	Media Walls	168
Nova Reception Panels	72	NEW Parthos Meeting Tables	170
Cosy Reception Desk	76	STORAGE + PEDESTALS	176
Tera Reception Desks	78	Cube + Spectrum Storage	178
Ice Reception Desks	84	Nova Pedestals + Cupboards + Lockers	182
EXECUTIVE FURNITURE	86	Optima Pedestals + Filing Cabinets	190
NEW Arqus Executive Desks + Storage	88	Boxi Towers	196
Nova Executive Desks + Storage	96	Uni + Uni Plus Storage	202
Move & Lead Executive Desks + Storage	100	Choice Storage	216
Plana Executive Desks + Storage	108	WorkLab Mobile Shelving	242
Motion Executive Desks + Pedestals	120	Combus Zoning Shelving	252

SCREENS + ACOUSTIC PANELS	280	Wait Conference Chairs + Stools	454
Formetiq® Fabric Desktop Screens	282	Twist & Sit Meeting + Lounge Chairs	458
Formetiq® Perspex® Desktop Screens	286	Twist & Sit Soft Lounge Chairs + Sofas	468
Round PET Felt Screens	288	Tula Lounge Chairs	478
Narbutas Fabric + Plexiglas® Desktop Screens	292	Meg Lounge Chairs	482
MySpace Fabric Screens	308	Luna Lounge Chairs	484
Freestanding Acoustic Screens	316	Danae Lounge Chairs	486
Acoustic Artwork Panels + Clouds + Tiles	320	Vegas Lounge Chairs	490
NEW Parthos Acoustic Columns	324	Pixel Lounge Seating	492
Modus + Modus Light Acoustic Panels	328	NEW Cannie Stools	494
WORKPODS + BOOTHS	332	Wobby Task Stool	496
Silent Room	334	Soft Rock Modular Soft Seating	498
Jazz Box	362	Jazz Chill Out Modular Soft Seating	506
Arcipelago Wood	366	Giro Poufs	512
SEATING	370	Arcipelago Modular Soft Seating	514
Modena Task Chairs	372	ACCESSORIES	526
Verona Task Chair	380	Monitor Arms	528
Veneto Task + Executive Chairs	384	Power Modules / Supplies	536
Oslo Operator + Meeting Chairs	386	CPU Holders / Desk Mounts	554
Havana Meeting / Canteen Chairs	388	Cable Management	556
Madrid Meeting Chairs	392	Anti-fatigue Mats	560
Prague Meeting Chair	398	Coat Racks	562
Palermo Meeting / Canteen Chairs	402	Metal Under-desk Drawers	563
Seattle Meeting / Canteen Chairs	406	FINISHES + FABRICS	564
Eva 2 Task + Meeting Chairs	410	Finish Options	566
Wind Task + Meeting Chairs	416	Finishes Comparison Chart	568
North Cape Task + Exec. + Meeting Chairs	436	Fabric Options	570
Moon Task + Conference + Meeting Chairs	444	Fabric Comparison Chart	576
Gama Conference Meeting Chairs	450		

Experience the difference Join our global dealer network

We stock and sell our three brands of office furniture and accessories exclusively to the trade so we never compete with our dealers. Your business is our business, so we strive to support you with sales leads and extensive resources.



formetiq®

Our innovative range of contemporary furniture is designed to efficiently enable modern working environment and practice.

Everything we create aligns with our three core beliefs: it must look beautiful (form), work well for you (function) and be made in the most resource-effective manner (intelligent design). We aim to redefine work as a place that feels right so choosing furniture for the workplace should be a pleasure not a chore. Time spent in a well-designed workspace will be a pleasure too and an improved working environment invariably brings increased productivity.

narbutas

Narbutas design and manufacture modern, durable and functional furniture from their 36,600m² factory headquarters in Lithuania.

As Narbutas' largest accredited partner-distributor, we bring unique product expertise and unrivalled service to every workspace design project. With Arrow not only can you order any item from the entire Narbutas range (no minimum order) but we also hold large amounts of Narbutas stock.

Some of Arrow's sales and support staff come from dealer backgrounds, so we can empathise with your challenges in a way other manufacturers can't.



M METALICON®

Our range of ergonomic office furniture accessories.

Intelligently designed by our team of experts, the Metalicon® range was launched back in 2013 in response to a growing need for robust but refined accessories to support the office furniture market. We now supply our patented Metalicon® products to customers worldwide.

The Metalicon range includes pole and gas-lift monitor arms, CPU holders, sit/stand desk mats, vertical cable managers and power modules.



Reassuring quality

As well as being fantastic value for money all Narbutas, Formetiq® and Metalicon® products conform to relevant European or British manufacturing standards.

Guaranteed results

We offer a minimum 5 year guarantee on all our non-electrical products, including sit/stand desks, and minimum 1 year guarantee on all our electrical products. Metalicon Boost, Powerlink, Solo and Access modules now come with an extended 5 year guarantee! Narbutas offer a 10 year manufacturer warranty on the majority of their products. Exclusions apply.*



Looking after our planet

All our timber products are Rainforest Alliance, FSC or similarly accredited.

Since 2018 we have been focused on eliminating plastic from our product packaging. The majority of our Metalicon® packaging is already made using recycled paper-based materials which can also be recycled again and our aim is to have all our own branded packaging completely plastic free by 2023. Look out for our Ocean Friendly logo on Metalicon® product packaging.



INSTALLATION

Did you know Arrow have our own full time directly employed installation teams? Highly trained and skilled, we offer a comprehensive service including installation of other manufacturers' products alongside our own. For an effective solution to eliminate third parties and extra suppliers, why not ask us for an install quote on your next order?



SPACE PLANNING

You can increase the efficiency of your office by making the most of the space available. Thanks to the wide variety of desk shapes and sizes in our furniture ranges, you can plan your layout the way you want it. For help and advice with the design of your office space, please speak to our Sales Team, we will be glad to assist you in any way we can.

FAST TRACK DELIVERY

Many items are carried in stock in a variety of popular colours. All stock items are available on a fast delivery service, we love hitting a deadline. Factory and project orders are typically three to four weeks, so do discuss your delivery requirements in good time for your project.



* 5 years on drawers, sliding and tambour doors, worksurfaces, foam parts, upholstery materials (fabric, textile).

Desking

Bench desks

Cantilever desks

Panel desks

Sit/Stand desks



Round desk range

Nova

Bench desking system

See Nova desktop screens



There's beauty in simplicity, and Nova combines clean and minimal aesthetics with great functionality.

The Nova shared leg system keeps costs to a minimum. Metal-to-metal construction and reduces assembly time with just one tool required.

Choose from 3 leg frame options: goalpost (U), angled (A) and loop (O) as well as 3 types of desktop: straight back, scoop back or with an integrated cable flap.

Straight leg desks are available with a sliding desktop option offering up to 140mm of movement and allowing easy access to cable management beneath the desk.

The Nova range also offers a manual height adjustable desk frame option with a height range of 620-850 mm.

Nova desks are available in 9 different desktop finishes and 4 metal leg/frame finishes.

[See cable management](#)

Range

Nova U, A, O single desks



Nova U Slide single desks



Nova U, A, O single row benches



Nova H single desks



Nova U, A, O benches

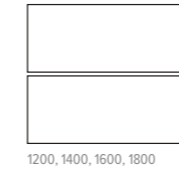

Nova U Slide benches

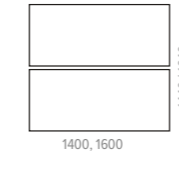

Nova U, A, O Crescent desks

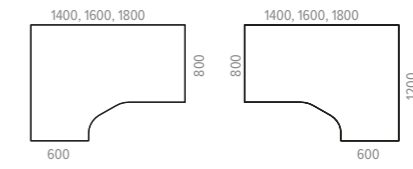

Nova U, A, O benches



Nova U Slide benches



Nova U 3-desk bench

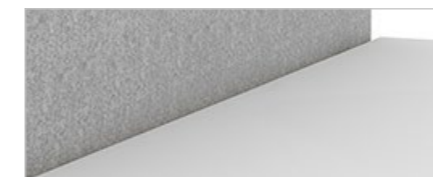
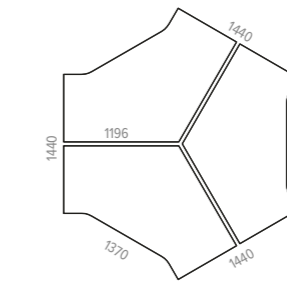

Straight back desktop

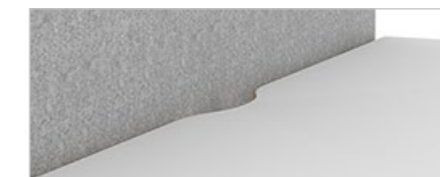

Scoop back desktop*



Desktop with cable flap**

Technical details

Desktop

- 25mm MFC with 2mm ABS edging
- 10mm gap between the legs and the desktop
- 40mm gap between the desktops on back-to-back benches

Metal beam

- 40 x 20 mm metal tube with welded metal plates for leg fixing
- Powder coated metal, colour matches legs

Metal legs

- 40 x 40 mm welded metal tube
- Powder coated metal
- Plastic height levelling feet (+10mm)

Materials

G1: Band A MFC

- Whitened Oak (D1)
- Amber Oak (D2)
- White (M1)
- White with Amber Oak edge (M1D2)
- Pearl Grey (N3)
- Dark Grey (N1)







G2: Band B MFC







- Sand Ash (D3)
- Dark Walnut (D4)
- Grey Wood (D5)
- Cubanit Grey (N2)
- Black (J4)









Frame Metal

- Black (A)
- White (E)
- Grey (M)
- Dark Grey (T1)

* Scoop back desktop not available on crescent desks
 ** Desktops with cable port not available on sliding desktops









	CODE	DESCRIPTION	WIDTH	DEPTH	HEIGHT	G1 (£)	G2 (£)	
	DNA124	Single desk with straight back	1200	600	740	360	395	
	DNA144		1400	600	740	398	421	
	DNA122		1200	700	740	410	445	
	DNA142		1400	700	740	426	448	
	DNA162		1600	700	740	448	476	
	DNA182		1800	700	740	530	575	
	DNA120		1200	800	740	446	467	
	DNA140		1400	800	740	456	485	
	DNA160		1600	800	740	478	512	
	DNA180		1800	800	740	511	551	
	DNA126	Single desk with scoop back	1200	700	740	427	466	
	DNA146		1400	700	740	444	476	
	DNA166		1600	700	740	471	510	
	DNA186		1800	700	740	513	569	
	DNA125		1200	800	740	446	485	
	DNA145		1400	800	740	456	494	
	DNA165		1600	800	740	489	529	
	DNA185		1800	800	740	533	591	
		DNA123	Single desk with cable port cutout <i>Cable port insert (ZNZ010) must be ordered</i>	1200	700	740	410	445
		DNA143		1400	700	740	444	459
DNA163			1600	700	740	453	492	
DNA183			1800	700	740	530	575	
DNA121			1200	800	740	446	467	
DNA141			1400	800	740	466	494	
DNA161			1600	800	740	489	529	
DNA181			1800	800	740	539	591	
		DNC080	Desk return	800	600	740	231	248
		DNC060	Desk return - only available with goalpost (U) leg	600	800	740	250	262
	S-DND12C	Extension for inline bench with straight back	1200	700	740	449	491	
	S-DND14C		1400	700	740	457	501	
	S-DND16C		1600	700	740	483	533	
	S-DND18C		1800	700	740	586	636	
	DND12A		1200	800	740	390	412	
	DND14A		1400	800	740	400	428	
	DND16A		1600	800	740	439	480	
	DND18A		1800	800	740	461	501	
		S-DND12E	Extension for inline bench with scoop back	1200	700	740	483	526
		S-DND14E		1400	700	740	483	517
S-DND16E			1600	700	740	501	543	
S-DND18E			1800	700	740	586	636	
DND128			1200	800	740	390	430	
DND148			1400	800	740	407	439	
DND168			1600	800	740	434	474	
DND188			1800	800	740	478	533	



	CODE	DESCRIPTION	WIDTH	DEPTH	HEIGHT	G1 (£)	G2 (£)	
	S-DND12D	Extension for inline bench with cable port cutout <i>Cable port insert (ZNZ010) must be ordered</i>	1200	700	740	449	491	
	S-DND14D		1400	700	740	483	517	
	S-DND16D		1600	700	740	501	543	
	S-DND18D		1800	700	740	586	636	
	DND12B		1200	800	740	390	412	
	DND14B		1400	800	740	418	439	
	DND16B		1600	800	740	434	474	
	DND18B		1800	800	740	484	533	
	DNH120	Top hung MFC modesty panel for W1200 desk*	1040	16	350	62	67	
	DNH140	Top hung MFC modesty panel for W1400 desk*	1240	16	350	71	77	
	DNH160	Top hung MFC modesty panel for W1600 desk*	1440	16	350	77	84	
	DNH180	Top hung MFC modesty panel for W1800 desk*	1640	16	350	87	92	
	DNH200	Top hung MFC modesty panel for W2000 desk*	1840	16	350	92	99	
	DNS123	2 desk back-to-back bench with straight back	1200	1440	740	682	743	
	DNS143		1400	1440	740	706	758	
	DNS163		1600	1440	740	751	806	
	DNS183		1800	1440	740	916	1,006	
	DNS122		1200	1640	740	748	795	
	DNS142		1400	1640	740	765	825	
	DNS162		1600	1640	740	815	888	
	DNS182		1800	1640	740	887	966	
		DNS127	2 desk back-to-back bench with scoops	1200	1440	740	710	787
		DNS147		1400	1440	740	740	808
DNS167			1600	1440	740	801	879	
DNS187			1800	1440	740	889	996	
DNS126			1200	1640	740	748	827	
DNS146			1400	1640	740	775	842	
DNS166			1600	1640	740	837	916	
DNS186			1800	1640	740	926	1,033	
		DNS125	2 desk back-to-back bench with cable port cutout <i>Cable port insert (ZNZ010) must be ordered</i>	1200	1440	740	682	743
		DNS145		1400	1440	740	740	779
	DNS165		1600	1440	740	768	840	
	DNS185		1800	1440	740	916	1,006	
	DNS124		1200	1640	740	748	795	
	DNS144		1400	1640	740	798	842	
	DNS164		1600	1640	740	837	916	
	DNS184		1800	1640	740	936	1,033	
		DND123	Extension for 2 desk bench with straight back	1200	1440	740	646	707
		DND143		1400	1440	740	675	721
DND163			1600	1440	740	715	770	
DND183			1800	1440	740	879	970	
DND122			1200	1640	740	714	765	
DND142			1400	1640	740	734	792	
DND162			1600	1640	740	785	852	
DND182			1800	1640	740	850	929	

	CODE	DESCRIPTION	WIDTH	DEPTH	HEIGHT	G1 (£)	G2 (£)
	DND129	Extension for 2 desk bench with scoop back	1200	1440	740	673	751
	DND149		1400	1440	740	705	771
	DND169		1600	1440	740	766	844
	DND189		1800	1440	740	852	959
	DND127		1200	1640	740	714	793
	DND147		1400	1640	740	741	813
	DND167		1600	1640	740	801	879
	DND187		1800	1640	740	890	1,002
		DND125	Extension for 2 desk bench with cable port cutouts <i>Cable port insert (ZNZ010) must be ordered</i>	1200	1440	740	646
DND145			1400	1440	740	705	743
DND165			1600	1440	740	732	804
DND185			1800	1440	740	879	970
DND124			1200	1640	740	714	765
DND144			1400	1640	740	762	813
DND164			1600	1640	740	801	879
DND184			1800	1640	740	902	1,002
		S-DNA146	Full width bench end extension with scoop back and joining plates	1440	700	740	682
	S-DNA165		1640	800	740	724	811
	DNC141	Bench end extension*	1440	600	740	275	284
	DNC161		1640	600	740	281	304
	DNA151	Sliding top desk with straight back	1400	700	740	497	526
	DNA171		1600	700	740	535	563
	DNA153		1400	800	740	537	569
	DNA173		1600	800	740	574	607
	DNA152	Sliding top desk with scoop back	1400	700	740	513	542
	DNA172		1600	700	740	550	583
	DNA154		1400	800	740	546	581
	DNA174		1600	800	740	580	623
	DNS150	Sliding top 2 desk back-to-back bench with straight back	1400	1440	740	850	912
	DNS170		1600	1440	740	930	981
	DNS152		1400	1640	740	934	1,002
	DNS172		1600	1640	740	1,005	1,073
	DNS151	Sliding top 2 desk back-to-back bench with scoop back	1400	1440	740	884	941
	DNS171		1600	1440	740	954	1,027
	DNS153		1400	1640	740	952	1,025
	DNS173		1600	1640	740	1,022	1,101
		DND152	Extension for sliding desktop bench with straight back	1400	1440	740	814
DND172			1600	1440	740	894	945
DND154			1400	1640	740	900	972
DND174			1600	1640	740	970	1,037

* Only available in goalpost leg (U) frame

Prices shown are for straight goal post (U) legs. Additional costs apply for angled (A) and loop (O) legs (see page 13).

	CODE	DESCRIPTION	WIDTH	DEPTH	HEIGHT	G1 (£)	G2 (£)
	DND153	Extension for sliding desktop bench with scoop back	1400	1440	740	848	904
	DND173		1600	1440	740	918	992
	DND155		1400	1640	740	922	988
	DND175		1600	1640	740	992	1,072
	DNA120-UH	Manual height settable desk with straight back	1200	800	620-850	583	605
	DNA140-UH		1400	800	620-850	593	621
	DNA160-UH		1600	800	620-850	615	649
	DNA180-UH		1800	800	620-850	654	693
	DNA125-UH	Manual height settable desk with scoop back	1200	800	620-850	583	621
	DNA145-UH		1400	800	620-850	598	633
	DNA165-UH		1600	800	620-850	627	666
	DNA185-UH		1800	800	620-850	671	727
	DNA121-UH	Manual height settable desk with cable port cutout <i>Cable port insert (ZNZ010) must be ordered</i>	1200	800	620-850	583	605
	DNA141-UH		1400	800	620-850	605	633
	DNA161-UH		1600	800	620-850	627	666
	DNA181-UH		1800	800	620-850	676	727
	DNL140	L/H crescent desk with straight back	1400	1200	740	586	632
	DNL160		1600	1200	740	612	657
	DNL180		1800	1200	740	653	691
	DNR140	R/H crescent desk with straight back	1400	1200	740	586	632
	DNR160		1600	1200	740	612	657
	DNR180		1800	1200	740	653	691
	DNL141	L/H crescent desk with cable port cutout <i>Cable port insert (ZNZ010) must be ordered</i>	1400	1200	740	554	610
	DNL161		1600	1200	740	600	657
	DNL181		1800	1200	740	670	725
	DNR141	R/H crescent desk with cable port cutout <i>Cable port insert (ZNZ010) must be ordered</i>	1400	1200	740	554	610
	DNR161		1600	1200	740	600	657
	DNR181		1800	1200	740	670	725
	DNS128	3 desk bench (120° desks) with scoop back - only available with goalpost (U) leg	Ø2810	-	740	2,023	2,201
	DNZ102	Panel insert for W1440mm loop leg (O) frame bench	1336	18	595	234	247
	DNZ101	Panel insert for W1640mm loop leg (O) frame bench	1536	18	595	252	270

	DESCRIPTION	RSP (£)
	Alternative angled (A) or loop (O) legs for D600mm single desk	+26
	Alternative angled (A) or loop (O) legs for D700mm single desk	+21
	Alternative angled (A) or loop (O) legs for D800mm single desk	+21
	Alternative angled (A) or loop (O) legs for D800mm return	+13
	Alternative angled (A) or loop (O) legs for D1440mm back-to-back bench	+65
	Alternative angled (A) or loop (O) legs for D1640mm back-to-back bench	+60
	Alternative angled (A) or loop (O) legs for D1200mm crescent desk	+23

Nova Wood

Bench desking system



The Nova Wooden leg desk range features solid wooden legs that are lacquered and stained in a natural ash finish with metal inserts for assembly and hidden height levelling feet.

The desks are easy to install with metal-to-metal fixings and require only one tool for assembly. The high pressure laminate desktop option features a tapered underside edge portraying a sharp, delicate edge which is softened by curved corners and inset wooden legs in a natural ash finish.

HPL Fenix

The HPL Fenix finish option is a surface treated with next-generation resins, hardened and fixed through a nanotechnology process giving the surface unique qualities including a super matt finish with low-light reflectivity, an ultra-resistant soft touch surface which is resistant to scratches and abrasion. Any micro scratches can be removed with heating.

[See cable management](#)

Range

MFC top with straight ABS edge

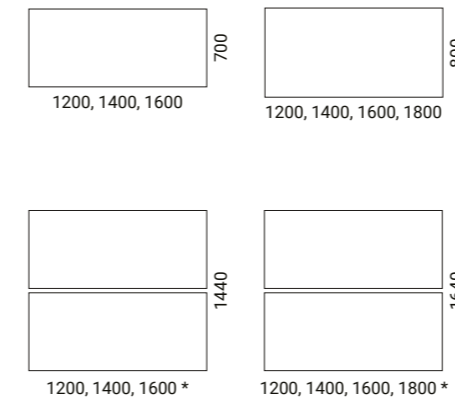

HPL / HPL Fenix top with chamfered edge and rounded corners

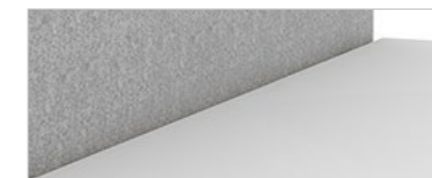
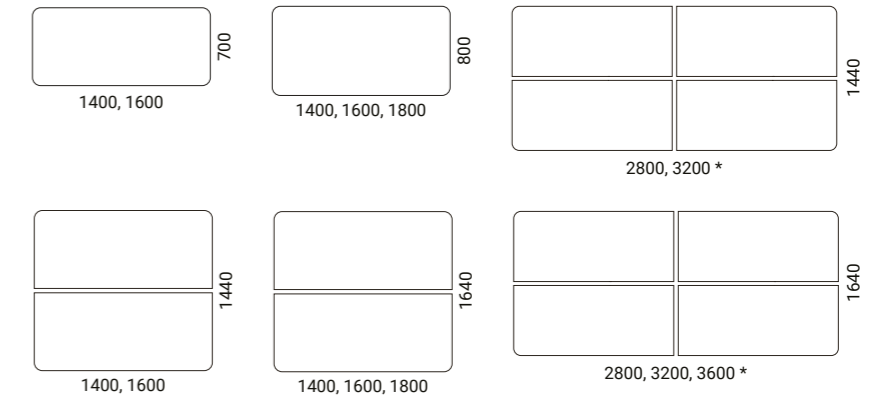

Straight back desktop



Scoop back desktop

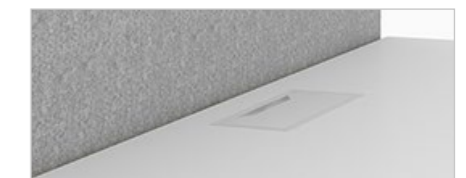

Desktop with cable flap

Technical details

Desktop

- 25mm MFC with 2mm ABS edging
- 26mm MDF covered in HPL with chamfered painted edges
- The chamfered edge is on the underside of the table and is 77mm deep tapering from 26mm to 11mm at the table edge
- Corners of chamfered desktop are rounded: R100mm
- 10mm gap between the legs and the desktop
- 40mm gap between the desktops in back-to-back benches

Metal beam

- 40 x 20 mm metal tube with welded metal plates for leg fixing
- Powder coated metal

Legs

- Lacquered and stained natural ash solid wood
- Glued wood construction with metal inserts for fixing
- Plastic height levelling feet (+10mm)
- Central solid wood leg fixed into powder coated metal tube: 120x40 mm

Materials

Band A MFC

- Whitened Oak (D1)
- Amber Oak (D2)
- White (M1)
- White with Amber Oak edge (M1D2)
- Pearl Grey (N3)
- Dark Grey (N1)

Band B MFC

- Sand Ash (D3)
- Dark Walnut (D4)
- Grey Wood (D5)
- Cubanit Grey (N2)
- Black (J4)

HPL / Fenix

- White top, black edge (H70B01)
- White top, white edge (H70B02)
- Black top, black edge (H16B01)
- Grey top, grey edge (H17B03)





Solid wood legs





- Stained Ash (W2)
- Ash stained Black (W3)







Frame Metal







- Dark Grey (T1) - MFC desks only
- Black (A)
- Grey (M) - MFC desks only
- White (E)

*To increase the number of workplaces, use supplementary units.
Please note: Chamfered edge extension units can only be added to 4 desk benches

	CODE	DESCRIPTION	G1: Band A MFC		G2: Band B MFC		
			WIDTH	DEPTH	HEIGHT	G1 (£)	G2 (£)
	DNA122-W	Single desk with straight back	1200	700	740	895	926
	DNA142-W		1400	700	740	914	936
	DNA162-W		1600	700	740	935	967
	DNA120-W		1200	800	740	961	986
	DNA140-W		1400	800	740	973	1,004
	DNA160-W		1600	800	740	997	1,033
	DNA180-W		1800	800	740	1,038	1,081
	DNA126-W	Single desk with scoop back	1200	700	740	914	957
	DNA146-W		1400	700	740	931	968
	DNA166-W		1600	700	740	960	1,003
	DNA125-W		1200	800	740	961	1,004
	DNA145-W		1400	800	740	980	1,017
	DNA165-W		1600	800	740	1,008	1,052
	DNA185-W		1800	800	740	1,056	1,117
	DNA123-W	Single desk with cable port cutout <i>Cable port insert (ZNZ010) must be ordered</i>	1200	700	740	895	926
	DNA143-W		1400	700	740	931	950
	DNA163-W		1600	700	740	943	979
	DNA121-W		1200	800	740	961	986
	DNA141-W		1400	800	740	986	1,017
	DNA161-W		1600	800	740	1,008	1,052
	DNA181-W		1800	800	740	1,062	1,117
	DNS123-W	Back-to-back 2 desk bench with straight back	1200	1440	740	1,441	1,506
	DNS143-W		1400	1440	740	1,475	1,523
	DNS163-W		1600	1440	740	1,515	1,575
	DNS122-W		1200	1640	740	1,576	1,631
	DNS142-W		1400	1640	740	1,602	1,661
	DNS162-W		1600	1640	740	1,652	1,725
	DNS182-W		1800	1640	740	1,725	1,810

	CODE	DESCRIPTION	WIDTH	DEPTH	HEIGHT	G1 (£)	G2 (£)
	DNS127-W	Back-to-back 2 desk bench with scoop back	1200	1440	740	1,470	1,556
	DNS147-W		1400	1440	740	1,505	1,578
	DNS167-W		1600	1440	740	1,569	1,653
	DNS126-W		1200	1640	740	1,576	1,662
	DNS146-W		1400	1640	740	1,607	1,686
	DNS166-W		1600	1640	740	1,670	1,756
	DNS186-W		1800	1640	740	1,768	1,889
	DNS125-W	Back-to-back 2 desk bench with cable port cutouts <i>Cable port insert (ZNZ010) must be ordered</i>	1200	1440	740	1,441	1,506
	DNS145-W		1400	1440	740	1,505	1,549
	DNS165-W		1600	1440	740	1,532	1,611
	DNS124-W		1200	1640	740	1,576	1,631
	DNS144-W		1400	1640	740	1,631	1,686
	DNS164-W		1600	1640	740	1,670	1,756
	DNS184-W		1800	1640	740	1,780	1,889
	DND123-W	Extension for back-to-back bench with straight back	1200	1440	740	858	921
	DND143-W		1400	1440	740	888	943
	DND163-W		1600	1440	740	932	995
	DND122-W		1200	1640	740	921	968
	DND142-W		1400	1640	740	936	1,004
	DND162-W		1600	1640	740	988	1,069
	DND182-W		1800	1640	740	1,069	1,153
	DND129-W	Extension for back-to-back bench with scoop back	1200	1440	740	889	974
	DND149-W		1400	1440	740	924	997
	DND169-W		1600	1440	740	981	1,068
	DND127-W		1200	1640	740	921	1,004
	DND147-W		1400	1640	740	950	1,023
	DND167-W		1600	1640	740	1,014	1,098
	DND187-W		1800	1640	740	1,110	1,226
	DND125-W	Extension for 2 desk back-to-back bench with cable port cutouts <i>Cable port insert (ZNZ010) must be ordered</i>	1200	1440	740	858	921
	DND145-W		1400	1440	740	924	967
	DND165-W		1600	1440	740	951	1,024
	DND124-W		1200	1640	740	921	968
	DND144-W		1400	1640	740	973	1,023
	DND164-W		1600	1640	740	1,014	1,098
	DND184-W		1800	1640	740	1,124	1,226

	CODE	DESCRIPTION	G1: HPL		G2: HPL Fenix		
			WIDTH	DEPTH	HEIGHT	G1 (£)	G2 (£)
	DNA14E-W	Chamfered edge single desk with straight back	1400	700	740	1,091	1,529
	DNA16E-W		1600	700	740	1,142	1,641
	DNA14H-W		1400	800	740	1,168	1,667
	DNA16H-W		1600	800	740	1,221	1,799
	DNA18A-W		1800	800	740	1,291	1,947
	DNA14G-W	Chamfered edge single desk with scoop back	1400	700	740	1,103	1,559
	DNA16G-W		1600	700	740	1,154	1,670
	DNA14J-W		1400	800	740	1,174	1,697
	DNA16J-W		1600	800	740	1,235	1,836
	DNA18C-W		1800	800	740	1,309	1,978
	DNA14F-W	Chamfered edge single desk with cable port cutout <i>Cable port insert (ZNZO10) must be ordered</i>	1400	700	740	1,103	1,559
	DNA16F-W		1600	700	740	1,154	1,672
	DNA14I-W		1400	800	740	1,181	1,703
	DNA16I-W		1600	800	740	1,224	1,826
	DNA18B-W		1800	800	740	1,308	1,978
	DNS14F-W	Chamfered edge 2 desk back-to-back bench with straight back	1400	1440	740	1,814	2,701
	DNS16F-W		1600	1440	740	1,902	2,906
	DNS14C-W		1400	1640	740	1,987	2,989
	DNS16C-W		1600	1640	740	2,076	3,231
	DNS18C-W		1800	1640	740	2,204	3,488
	DNS14H-W	Chamfered edge 2 desk back-to-back bench with scoop back	1400	1440	740	1,832	2,750
	DNS16H-W		1600	1440	740	1,934	2,961
	DNS14E-W		1400	1640	740	1,995	3,024
	DNS16E-W		1600	1640	740	2,064	3,266
	DNS18E-W		1800	1640	740	2,235	3,574
	DNS14G-W	Chamfered edge 2 desk back-to-back bench with cable port cutouts <i>Cable port insert (ZNZO10) must be ordered</i>	1400	1440	740	1,832	2,750
	DNS16G-W		1600	1440	740	1,953	2,981
	DNS14D-W		1400	1640	740	1,997	3,026
	DNS16D-W		1600	1640	740	2,094	3,298
	DNS18D-W		1800	1640	740	2,241	3,578

	CODE	DESCRIPTION	WIDTH	DEPTH	HEIGHT	G1 (£)	G2 (£)
	DNS280-W	Chamfered edge 4 desk back-to-back bench with straight back	2800	1440	740	2,985	4,311
	DNS320-W		3200	1440	740	3,222	4,780
	DNS283-W		2800	1640	740	3,226	4,722
	DNS323-W		3200	1640	740	3,512	5,312
	DNS360-W		3600	1640	740	3,751	5,763
	DNS282-W	Chamfered edge 4 desk back-to-back bench with scoop back	2800	1440	740	3,000	4,373
	DNS322-W		3200	1440	740	3,205	4,762
	DNS285-W		2800	1640	740	3,244	4,808
	DNS325-W		3200	1640	740	3,487	5,287
	DNS362-W		3600	1640	740	3,751	5,763
	DNS281-W	Chamfered edge 4 desk back-to-back bench with cable port cutouts <i>Cable port insert (ZNZO10) must be ordered</i>	2800	1440	740	3,016	4,390
	DNS321-W		3200	1440	740	3,188	4,745
	DNS284-W		2800	1640	740	3,286	4,849
	DNS324-W		3200	1640	740	3,494	5,294
	DNS361-W		3600	1640	740	3,764	5,779
	DND140-W	Chamfered edge extension for 4 desk back-to-back bench with straight back	1400	1440	740	1,191	1,867
	DND160-W		1600	1440	740	1,290	2,037
	DND148-W		1400	1640	740	1,283	2,044
	DND168-W		1600	1640	740	1,419	2,265
	DND180-W		1800	1640	740	1,579	2,589
	DND146-W	Chamfered edge extension for 4 desk back-to-back bench with scoop back	1400	1440	740	1,212	1,887
	DND166-W		1600	1440	740	1,252	2,036
	DND14B-W		1400	1640	740	1,286	2,078
	DND16B-W		1600	1640	740	1,437	2,325
	DND183-W		1800	1640	740	1,569	2,579
	DND141-W	Chamfered edge extension for 4 desk back-to-back bench with cable port cutouts <i>Cable port insert (ZNZO10) must be ordered</i>	1400	1440	740	1,228	1,904
	DND161-W		1600	1440	740	1,359	2,145
	DND14A-W		1400	1640	740	1,308	2,099
	DND16A-W		1600	1640	740	1,427	2,316
	DND181-W		1800	1640	740	1,549	2,558

Round

Bench desking & storage system



See Round PET screens



The new Round desking system promises a win-win situation in organising workplaces in large open plan offices.

Round desk system allows you to effectively use the office space and to easily create comfortable workplaces which can be either open or which can offer greater privacy to fit your team's needs. This system offers everything you need to create efficiently designed workplaces which boost employee productivity and help them succeed in pursuing their goals.

Supplementary units are available in rectangular only. For rounded single row benches you must start with a 2-desk bench. For rounded back-to-back benches with more than 2 desks you must start with a 4-desk bench.

[See cable management](#)

Desks range

Rounded

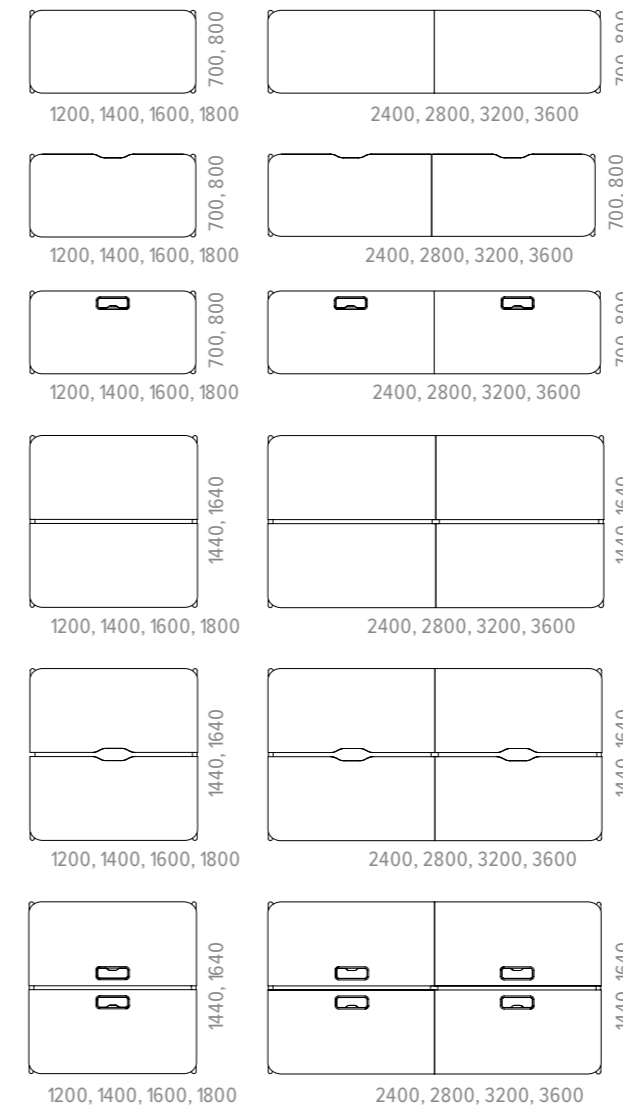

Rectangular

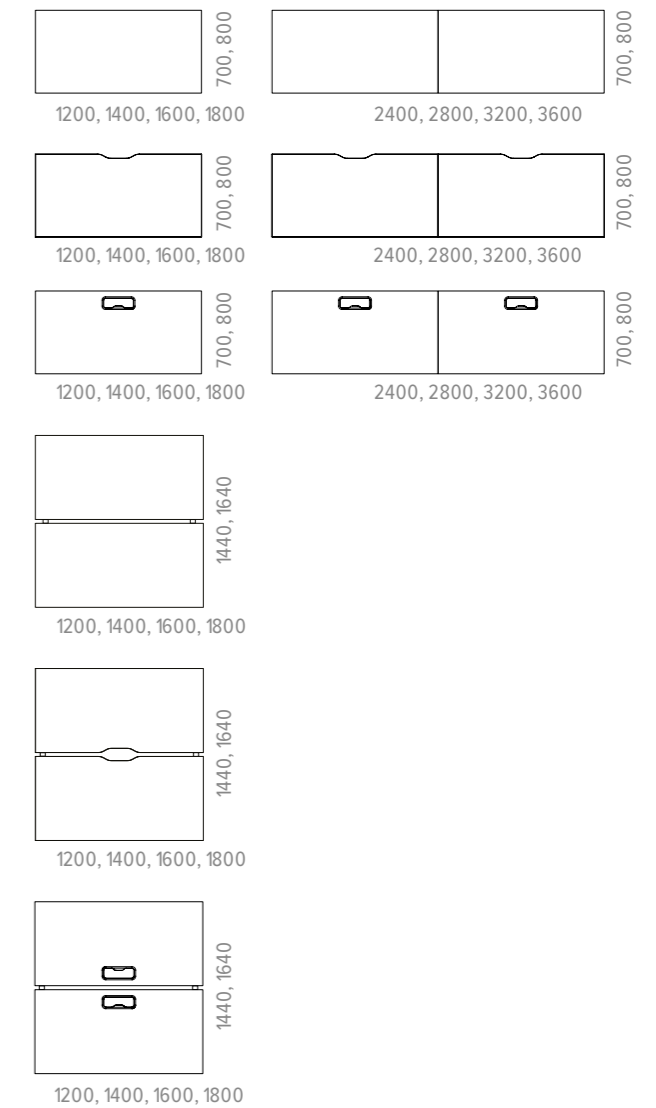

Rounded sliding desktop

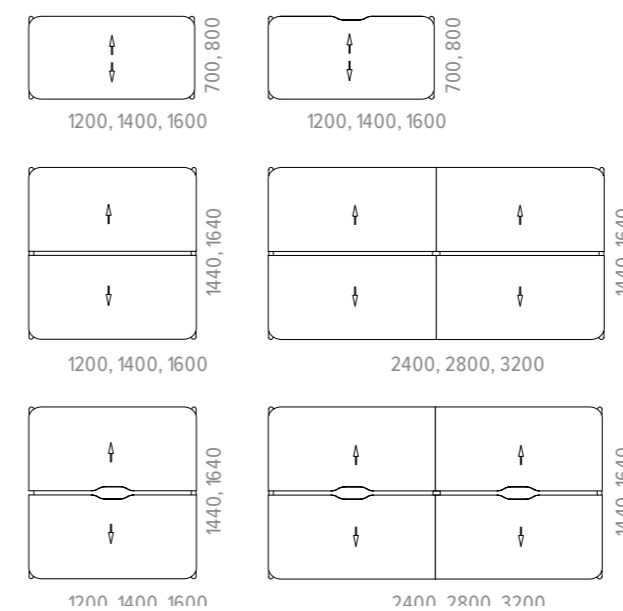

Rectangular sliding desktop

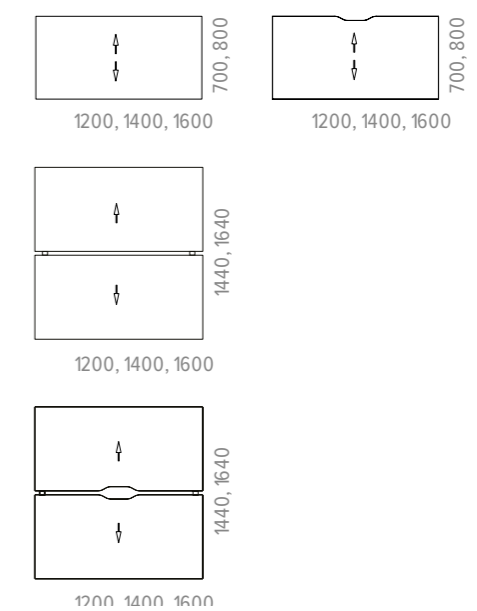

Workstations range

Rounded

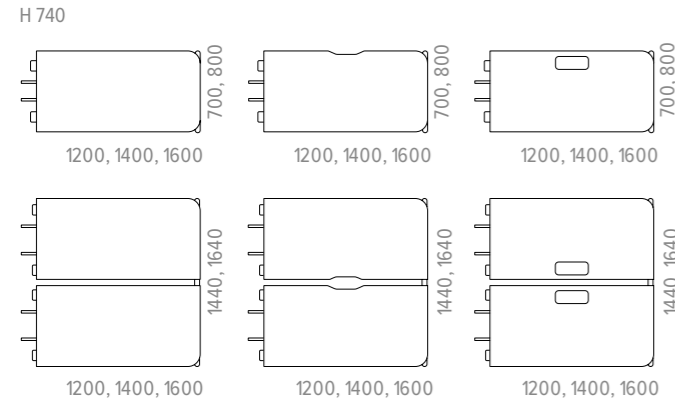

Rectangular

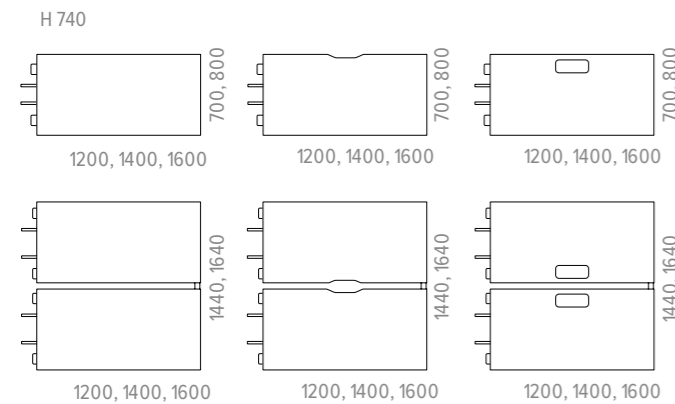

Cabinets

W900, D400 (D420 with doors), H565

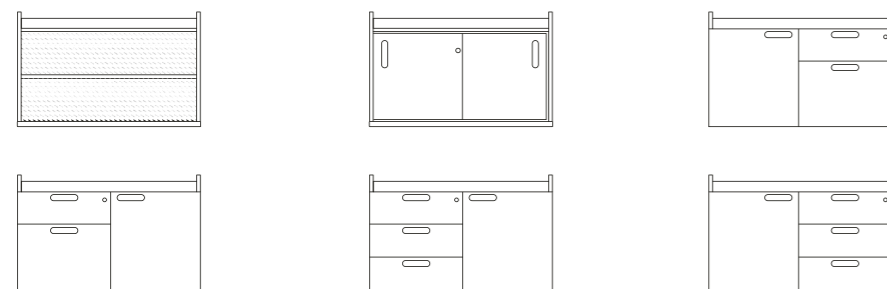

Shelving units

W1800, D400, H380

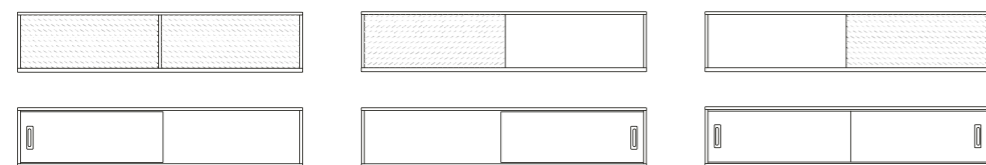

W1800, D400, H742

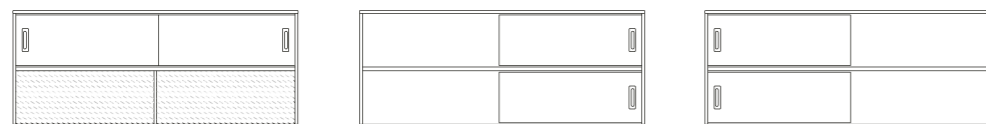

Technical details



Straight back desktop

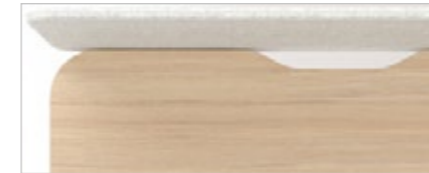

Scoop back desktop



Desktop with cable flap



Rounded desktop



Rectangular desktop

DESKS

Desktop

- 25mm MFC with 2mm ABS edges
- MFC table top with 2mm ABS edging or R100mm rounded corners
- 8mm gap between the legs and the desktop
- 40 mm gap between the desktops in back to back benches (depth of benches – 1440/1640 mm)

Metal beam

- Metal tube – 40 x 20 mm
- With welded metal plates for Round leg fixing
- Powder coated metal

Legs

- Bended metal tube D40 x 2 mm
- Powder coated metal
- Plastic feet with height levelling (10mm)

Central leg (if applicable)

- Assembled leg from metal tube D40 x 2 mm welded parts

Screens and accessories

- Nova fabric
- Round cable trays

CABINETS / SHELVING UNITS

Carcass

- 18mm MFC with 1mm ABS edging

Top and bottom

- 18mm MFC with 1mm ABS edging
- 25mm MFC with 2mm ABS edging

Back

- 18mm MFC

Shelves

- 18mm MFC with 1mm ABS edging
- Shelf in open cabinet, max. load – 30kg
- Shelf in closed cabinet, max. load – 15kg

Sliding doors

- 18mm MFC with 1mm ABS edging
- With plastic runners
- Plastic slide profile

Handles

- Recessed handles 145 x 42 x 15 mm (EC, MC, AC, T1C) from aluminium, powder coated

CABINETS

Metal frame legs

- Powder coated metal
- Metal tube leg Ø30mm
- Metal beam 30 x 40 mm
- Plastic feet with height levelling (+10mm)

Doors

- Doors with hinges in 18mm MFC with 1mm ABS edging
- 107° opening angle with soft closing function

Drawers

- 16mm MFC with 1mm ABS edging (inside only white)
- Facade made of 18mm MFC with 1mm ABS edging;
- Bottom is made of 12mm MFC
- Full extension ball bearing slides with soft close, which are visible
- Central locking (without anti-tilt)
- Small drawer can hold up to 10kg, file drawer up to 20kg

SHELVING UNITS

Top panel

- 25mm MFC with 2mm ABS edging
- One size: 1800 x 400 x 25 mm

Fabric back panel

- 16mm MFC
- VB2240 foam (3mm)
- Upholstered with fabric
- One size: 896 x 482 x 22 mm

Materials

Band A MFC

- Whitened Oak (D1)
- Amber Oak (D2)
- White (M1)
- Dark Grey (N1)
- Pearl Grey (N3)

Band B MFC

- Sand Ash (D3)
- Dark Walnut (D4)
- Grey Wood (D5)
- Cubanit Grey (N2)
- Black (J4)







Metal legs







- Black (A)
- Grey (M)
- White (E)
- Dark Grey (T1)

Panel Fabric*

- Berta
- Lucia
- Velito Presto
- Synergy





* Not every fabric from these ranges is available on Narbutas products - please see Fabrics section at back of price list for details





		G1: Band A MFC		G2: Band B MFC				
	CODE	DESCRIPTION	WIDTH	DEPTH	HEIGHT	G1 (£)	G2 (£)	
	DBA124	Rounded desk	1200	700	740	493	527	
	DBA144		1400	700	740	512	539	
	DBA164		1600	700	740	531	576	
	DBA184		1800	700	740	627	684	
	DBA129		1200	800	740	525	563	
	DBA149		1400	800	740	542	581	
	DBA169		1600	800	740	574	612	
	DBA189		1800	800	740	618	675	
		DBA125	Rounded desk with cable port cutout <i>(ZZZ363 must be ordered)</i>	1200	700	740	493	527
DBA145			1400	700	740	527	558	
DBA165			1600	700	740	543	582	
DBA185			1800	700	740	627	684	
DBA12A			1200	800	740	525	563	
DBA14A			1400	800	740	568	586	
DBA16A			1600	800	740	585	643	
DBA18A			1800	800	740	637	700	
		DBA126	Rounded desk with scoop back	1200	700	740	520	564
	DBA146		1400	700	740	527	571	
	DBA166		1600	700	740	540	579	
	DBA186		1800	700	740	620	676	
	DBA12B		1200	800	740	525	569	
	DBA14B		1400	800	740	568	586	
	DBA16B		1600	800	740	585	643	
	DBA18B		1800	800	740	637	700	
		DBA127	Rounded desk with sliding desktop	1200	700	743	554	597
DBA147			1400	700	743	595	627	
DBA167			1600	700	743	637	668	
DBA12C			1200	800	743	603	641	
DBA14C			1400	800	743	634	672	
DBA16C			1600	800	743	678	723	
		DBA128	Rounded desk with sliding desktop and scoop back	1200	700	743	572	616
		DBA148		1400	700	743	607	646
		DBA168		1600	700	743	655	693
	DBA12D		1200	800	743	615	647	
	DBA14D		1400	800	743	646	685	
	DBA16D		1600	800	743	696	753	
	DBS123	Rounded 2-desk bench	1200	1440	740	823	894	
	DBS143		1400	1440	740	862	919	
	DBS163		1600	1440	740	895	978	
	DBS183		1800	1440	740	1,094	1,208	
	DBS128		1200	1640	740	904	973	
	DBS148		1400	1640	740	928	991	
	DBS168		1600	1640	740	982	1,058	
	DBS188		1800	1640	740	1,071	1,186	





	CODE	DESCRIPTION	WIDTH	DEPTH	HEIGHT	G1 (£)	G2 (£)
	DBS124	Rounded 2-desk bench with cable port cutouts <i>(ZZZ363 must be ordered)</i>	1200	1440	740	823	894
	DBS144		1400	1440	740	894	951
	DBS164		1600	1440	740	922	997
	DBS184		1800	1440	740	1,083	1,198
	DBS129		1200	1640	740	904	973
	DBS149		1400	1640	740	973	1,018
	DBS169		1600	1640	740	1,025	1,139
	DBS189		1800	1640	740	1,115	1,242
		DBS125	Rounded 2-desk bench with scoop backs	1200	1440	740	875
DBS145			1400	1440	740	894	977
DBS165			1600	1440	740	930	1,006
DBS185			1800	1440	740	1,084	1,199
DBS12A			1200	1640	740	904	993
DBS14A			1400	1640	740	982	1,026
DBS16A			1600	1640	740	1,005	1,118
DBS18A			1800	1640	740	1,129	1,242
		DBS126	Rounded 2-desk bench with sliding desktops	1200	1440	740	1,005
	DBS146		1400	1440	740	1,045	1,101
	DBS166		1600	1440	740	1,103	1,180
	DBS12B		1200	1640	740	1,090	1,161
	DBS14B		1400	1640	740	1,127	1,198
	DBS16B		1600	1640	740	1,209	1,292
	DBS127	Rounded 2-desk bench with sliding desktops and scoop backs	1200	1440	740	1,063	1,138
	DBS147		1400	1440	740	1,083	1,160
	DBS167		1600	1440	740	1,131	1,208
	DBS12C		1200	1640	740	1,090	1,180
	DBS14C		1400	1640	740	1,170	1,215
	DBS16C		1600	1640	740	1,240	1,355
	DBS24G	Rounded single row 2-desk bench	2400	700	740	879	950
	DBS28G		2800	700	740	924	981
	DBS32G		3200	700	740	954	1,032
	DBS36G		3600	700	740	1,146	1,260
	DBS243		2400	800	740	944	1,013
	DBS283		2800	800	740	970	1,039
	DBS323		3200	800	740	1,025	1,101
	DBS363		3600	800	740	1,103	1,218
		DBS24H	Rounded single row 2-desk bench with cable port cutouts <i>(ZZZ363 must be ordered)</i>	2400	700	740	874
DBS28H			2800	700	740	951	1,007
DBS32H			3200	700	740	982	1,058
DBS36H			3600	700	740	1,146	1,260
DBS244			2400	800	740	934	1,005
DBS284			2800	800	740	1,014	1,058
DBS324			3200	800	740	1,057	1,170
DBS364			3600	800	740	1,153	1,274

CODE	DESCRIPTION	G1: Band A MFC			G2: Band B MFC		
		WIDTH	DEPTH	HEIGHT	G1 (£)	G2 (£)	
DBS24J	Rounded single row 2-desk bench with scoop backs	2400	700	740	932	1,008	
DBS28J		2800	700	740	951	1,026	
DBS32J		3200	700	740	982	1,058	
DBS36J		3600	700	740	1,146	1,260	
DBS245		2400	800	740	934	1,024	
DBS285		2800	800	740	1,014	1,058	
DBS325		3200	800	740	1,057	1,170	
DBS365		3600	800	740	1,153	1,274	
DBS246	Rounded 4-desk bench	2400	1440	740	1,531	1,664	
DBS286		2800	1440	740	1,597	1,705	
DBS326		3200	1440	740	1,680	1,837	
DBS366		3600	1440	740	2,064	2,285	
DBS24B		2400	1640	740	1,667	1,800	
DBS28B		2800	1640	740	1,718	1,851	
DBS32B		3200	1640	740	1,826	1,978	
DBS36B		3600	1640	740	2,001	2,230	
DBS247	Rounded 4-desk bench with cable port cutouts <i>(ZZZ363 must be ordered)</i>	2400	1440	740	1,528	1,661	
DBS287		2800	1440	740	1,676	1,790	
DBS327		3200	1440	740	1,721	1,880	
DBS367		3600	1440	740	2,064	2,285	
DBS24C		2400	1640	740	1,683	1,816	
DBS28C		2800	1640	740	1,826	1,914	
DBS32C		3200	1640	740	1,910	2,139	
DBS36C		3600	1640	740	2,091	2,339	
DBS248	Rounded 4-desk bench with scoop backs	2400	1440	740	1,640	1,798	
DBS288		2800	1440	740	1,667	1,826	
DBS328		3200	1440	740	1,742	1,902	
DBS368		3600	1440	740	2,064	2,285	
DBS24D		2400	1640	740	1,667	1,845	
DBS28D		2800	1640	740	1,826	1,914	
DBS32D		3200	1640	740	1,910	2,139	
DBS36D		3600	1640	740	2,117	2,339	
DBS249	Rounded 4-desk bench with sliding desktops	2400	1440	743	1,894	2,034	
DBS289		2800	1440	743	1,980	2,093	
DBS329		3200	1440	743	2,089	2,248	
DBS24E		2400	1640	743	2,102	2,235	
DBS28E		2800	1640	743	2,167	2,307	
DBS32E		3200	1640	743	2,331	2,489	







CODE	DESCRIPTION	WIDTH	DEPTH	HEIGHT	G1 (£)	G2 (£)
DBS24A	Rounded 4-desk bench with sliding desktops and scoop backs	2400	1440	743	2,009	2,167
DBS28A		2800	1440	743	2,048	2,208
DBS32A		3200	1440	743	2,135	2,292
DBS24F		2400	1640	743	2,102	2,280
DBS28F		2800	1640	743	2,256	2,351
DBS32F		3200	1640	743	2,401	2,622
DAA124	Rectangular desk	1200	700	740	482	520
DAA144		1400	700	740	497	523
DAA164		1600	700	740	520	552
DAA184		1800	700	740	615	666
DAA129		1200	800	740	523	549
DAA149		1400	800	740	536	568
DAA169		1600	800	740	560	597
DAA189		1800	800	740	637	632
DAA125	Rectangular desk with a cable port cutout <i>(ZZZ363 must be ordered)</i>	1200	700	740	478	517
DAA145		1400	700	740	520	539
DAA165		1600	700	740	531	576
DAA185		1800	700	740	615	666
DAA12A		1200	800	740	523	549
DAA14A		1400	800	740	543	576
DAA16A		1600	800	740	574	617
DAA18A		1800	800	740	632	688
DAA126	Rectangular desk with scoop back	1200	700	740	510	549
DAA146		1400	700	740	520	558
DAA166		1600	700	740	531	576
DAA186		1800	700	740	615	666
DAA12B		1200	800	740	523	566
DAA14B		1400	800	740	549	581
DAA16B		1600	800	740	574	617
DAA18B		1800	800	740	632	688
DAA127	Rectangular desk with sliding desktop	1200	700	743	576	607
DAA147		1400	700	743	600	623
DAA167		1600	700	743	622	661
DAA12C		1200	800	743	613	645
DAA14C		1400	800	743	632	664
DAA16C		1600	800	743	675	714
DAA128	Rectangular desk with sliding desktop and scoop back	1200	700	743	601	638
DAA148		1400	700	743	612	649
DAA168		1600	700	743	635	673
DAA12D		1200	800	743	610	654
DAA14D		1400	800	743	646	672
DAA16D		1600	800	743	678	728







		G1: Band A MFC		G2: Band B MFC			
	CODE	DESCRIPTION	WIDTH	DEPTH	HEIGHT	G1 (£)	G2 (£)
	DAS123	Rectangular 2-desk bench	1200	1440	740	799	870
	DAS143		1400	1440	740	838	894
	DAS163		1600	1440	740	886	950
	DAS183		1800	1440	740	1,064	1,167
	DAS128		1200	1640	740	892	944
	DAS148		1400	1640	740	913	982
	DAS168		1600	1640	740	966	1,048
	DAS188		1800	1640	740	1,039	1,129
	DAS124	Rectangular 2-desk bench with cable port cutouts (ZZZ363 must be ordered)	1200	1440	740	805	875
	DAS144		1400	1440	740	874	919
	DAS164		1600	1440	740	905	986
	DAS184		1800	1440	740	1,064	1,167
	DAS129		1200	1640	740	892	944
	DAS149		1400	1640	740	942	992
	DAS169		1600	1640	740	993	1,082
	DAS189		1800	1640	740	1,109	1,217
	DAS125	Rectangular 2-desk bench with scoop backs	1200	1440	740	862	940
	DAS145		1400	1440	740	874	951
	DAS165		1600	1440	740	895	978
	DAS185		1800	1440	740	1,064	1,167
	DAS12A		1200	1640	740	892	981
	DAS14A		1400	1640	740	951	1,002
	DAS16A		1600	1640	740	993	1,082
	DAS18A		1800	1640	740	1,109	1,217
	DAS126	Rectangular 2-desk bench with sliding desktops	1200	1440	740	986	1,056
	DAS146		1400	1440	740	1,034	1,090
	DAS166		1600	1440	740	1,087	1,157
	DAS12B		1200	1640	740	1,079	1,136
	DAS14B		1400	1640	740	1,115	1,180
	DAS16B		1600	1640	740	1,200	1,274
	DAS127	Rectangular 2-desk bench with sliding desktops and scoop backs	1200	1440	740	1,044	1,120
	DAS147		1400	1440	740	1,065	1,141
	DAS167		1600	1440	740	1,113	1,189
	DAS12C		1200	1640	740	1,073	1,161
	DAS14C		1400	1640	740	1,139	1,198
	DAS16C		1600	1640	740	1,209	1,297







	CODE	DESCRIPTION	WIDTH	DEPTH	HEIGHT	G1 (£)	G2 (£)
	DAD12Z	Rectangular extension for single row 2-desk bench	1200	700	740	480	510
	DAD14Z		1400	700	740	488	519
	DAD16Z		1600	700	740	511	543
	DAD18Z		1800	700	740	605	656
	DAD124		1200	800	740	419	444
	DAD144		1400	800	740	432	463
	DAD164		1600	800	740	456	501
	DAD184		1800	800	740	496	540
	DAD12X	Rectangular extension for single row 2-desk bench with a cable port cutout (ZZZ363 must be ordered)	1200	700	740	476	508
	DAD14X		1400	700	740	510	530
	DAD16X		1600	700	740	529	566
	DAD18X		1800	700	740	605	656
	DAD125		1200	800	740	419	444
	DAD145		1400	800	740	447	472
	DAD165		1600	800	740	470	513
	DAD185		1800	800	740	528	584
	DAD12Y	Rectangular extension for single row 2-desk bench with scoop backs for wire management	1200	700	740	502	539
	DAD14Y		1400	700	740	510	549
	DAD16Y		1600	700	740	529	566
	DAD18Y		1800	700	740	605	656
	DAD126		1200	800	740	419	463
	DAD146		1400	800	740	451	477
	DAD166		1600	800	740	470	513
	DAD186		1800	800	740	528	584
	DAD127	Rectangular extension for desk benches	1200	1440	740	686	757
	DAD147		1400	1440	740	730	780
	DAD167		1600	1440	740	771	837
	DAD187		1800	1440	740	951	1,054
	DAD12C		1200	1640	740	758	814
	DAD14C		1400	1640	740	783	848
	DAD16C		1600	1640	740	838	913
	DAD18C		1800	1640	740	904	993
	DAD128	Rectangular extension for desk benches with cable port cutouts (ZZZ363 must be ordered)	1200	1440	740	692	762
	DAD148		1400	1440	740	761	805
	DAD168		1600	1440	740	792	873
	DAD188		1800	1440	740	951	1,054
	DAD12D		1200	1640	740	758	814
	DAD14D		1400	1640	740	805	863
	DAD16D		1600	1640	740	857	946
	DAD18D		1800	1640	740	973	1,088

		G1: Band A MFC			G2: Band B MFC		
	CODE	DESCRIPTION	WIDTH	DEPTH	HEIGHT	G1 (£)	G2 (£)
	DAD129	Rectangular extension for desk benches with scoop backs	1200	1440	740	748	825
	DAD149		1400	1440	740	761	838
	DAD169		1600	1440	740	782	864
	DAD189		1800	1440	740	951	1,054
	DAD12E		1200	1640	740	758	847
	DAD14E		1400	1640	740	816	872
	DAD16E		1600	1640	740	857	946
	DAD18E		1800	1640	740	973	1,088
	DAD12A	Rectangular extension for desk benches with sliding desktops	1200	1440	743	999	1,069
	DAD14A		1400	1440	743	1,046	1,103
	DAD16A		1600	1440	743	1,099	1,169
	DAD12F		1200	1640	743	1,070	1,127
	DAD14F		1400	1640	743	1,106	1,176
	DAD16F		1600	1640	743	1,189	1,264
	DAD12B	Rectangular extension for desk benches with sliding desktops and scoop backs	1200	1440	743	1,056	1,138
	DAD14B		1400	1440	743	1,077	1,160
	DAD16B		1600	1440	743	1,126	1,201
	DAD12G		1200	1640	743	1,062	1,151
	DAD14G		1400	1640	743	1,130	1,187
	DAD16G		1600	1640	743	1,205	1,294
	DBD12H	Rounded desk for integration with cabinet	1200	700	740	386	419
	DBD14H		1400	700	740	409	434
	DBD16H		1600	700	740	429	467
	DBD12L		1200	800	740	416	455
	DBD14L		1400	800	740	429	467
	DBD16L		1600	800	740	467	505















	CODE	DESCRIPTION	WIDTH	DEPTH	HEIGHT	G1 (£)	G2 (£)
	DBD12I	Rounded desk with scoop backs for integration with cabinet (L/H)	1200	700	740	412	450
	DBD14I		1400	700	740	416	455
	DBD16I		1600	700	740	441	481
	DBD12Q		1200	800	740	412	457
	DBD14Q		1400	800	740	455	473
	DBD16Q		1600	800	740	480	538
	DBD12J	Rounded desk with scoop backs for integration with cabinet (R/H)	1200	700	740	408	447
	DBD14J		1400	700	740	421	459
	DBD16J		1600	700	740	441	481
	DBD12M		1200	800	740	412	457
	DBD14M		1400	800	740	455	473
	DBD16M		1600	800	740	480	538
	DBD12O	Rounded desk with a cable port cutout (ZZZ363 must be ordered) for integration with cabinet (L/H)	1200	700	740	385	418
	DBD14O		1400	700	740	421	453
	DBD16O		1600	700	740	441	481
	DBD12W		1200	800	740	412	450
	DBD14W		1400	800	740	455	473
	DBD16W		1600	800	740	480	538
	DBD12K	Rounded desk with a cable port cutout (ZZZ363 must be ordered) for integration with cabinet (R/H)	1200	700	740	383	415
	DBD14K		1400	700	740	416	449
	DBD16K		1600	700	740	441	481
	DBD12N		1200	800	740	412	450
	DBD14N		1400	800	740	455	473
	DBD16N		1600	800	740	480	538
	DBD12P	Rounded 2-desk bench for integration with cabinet	1200	1440	740	700	765
	DBD14P		1400	1440	740	730	788
	DBD16P		1600	1440	740	786	862
	DBD12T		1200	1640	740	759	827
	DBD14T		1400	1640	740	783	853
	DBD16T		1600	1640	740	851	928
	DBD12R	Rounded 2-desk bench with a cable port cutout (ZZZ363 must be ordered) for integration with cabinet	1200	1440	740	698	762
	DBD14R		1400	1440	740	769	827
	DBD16R		1600	1440	740	811	886
	DBD12U		1200	1640	740	766	837
	DBD14U		1400	1640	740	838	881
	DBD16U		1600	1640	740	894	1,007











	CODE	DESCRIPTION	G1: Band A MFC		G2: Band B MFC		
			WIDTH	DEPTH	HEIGHT	G1 (£)	G2 (£)
	DBD12S	Rounded 2-desk bench with scoop backs for integration with cabinet	1200	1440	740	750	834
	DBD14S		1400	1440	740	766	848
	DBD16S		1600	1440	740	820	897
	DBD12V		1200	1640	740	759	853
	DBD14V		1400	1640	740	838	881
	DBD16V		1600	1640	740	894	1,007
	DAD12H	Rectangular desk for integration with cabinet	1200	700	740	377	409
	DAD14H		1400	700	740	392	418
	DAD16H		1600	700	740	416	455
	DAD12L		1200	800	740	410	435
	DAD14L		1400	800	740	422	455
	DAD16L		1600	800	740	453	491
	DAD12J	Rectangular desk with scoop backs for integration with cabinet	1200	700	740	406	444
	DAD14J		1400	700	740	415	453
	DAD16J		1600	700	740	434	472
	DAD12M		1200	800	740	410	455
	DAD14M		1400	800	740	436	467
	DAD16M		1600	800	740	467	511
	DAD12K	Rectangular desk with a cable port cutout (ZZZ363 must be ordered) for integration with cabinet	1200	700	740	375	406
	DAD14K		1400	700	740	415	434
	DAD16K		1600	700	740	434	472
	DAD12N		1200	800	740	410	435
	DAD14N		1400	800	740	431	463
	DAD16N		1600	800	740	467	511
	DAD12P	Rectangular 2-desk bench for integration with cabinet	1200	1440	740	675	745
	DAD14P		1400	1440	740	719	769
	DAD16P		1600	1440	740	776	840
	DAD12T		1200	1640	740	747	804
	DAD14T		1400	1640	740	774	838
	DAD16T		1600	1640	740	836	918
	DAD12R	Rectangular 2-desk bench with a cable port cutouts (ZZZ363 must be ordered) for integration with cabinet	1200	1440	740	683	750
	DAD14R		1400	1440	740	750	796
	DAD16R		1600	1440	740	796	871
	DAD12U		1200	1640	740	747	804
	DAD14U		1400	1640	740	796	853
	DAD16U		1600	1640	740	862	951
	DAD12S	Rectangular 2-desk bench with scoop backs for integration with cabinet	1200	1440	740	739	816
	DAD14S		1400	1440	740	750	827
	DAD16S		1600	1440	740	786	862
	DAD12V		1200	1640	740	747	837
	DAD14V		1400	1640	740	805	862
	DAD16V		1600	1640	740	862	951













	CODE	DESCRIPTION	G1: Band A MFC		G2: Band B MFC		
			WIDTH	DEPTH	HEIGHT	G1 (£)	G2 (£)
	DRZ003	Cabinet top	1800	400	25	122	163
	D1N180	Open shelf unit (single-sided)	1800	400	380	290	384
	D1N181	Open shelf unit (two-sided, R/H)	1800	400	380	290	384
	D1N182	Open shelf unit (two-sided, L/H)	1800	400	380	290	384
	D2N090	Open cabinet (with adjustable shelf, \ with cutout on right side (left side add unit)	900	400	565	401	472
	D2N091	Open cabinet (with adjustable shelf, \ with cut-out in left side (right side add unit).	900	400	565	401	472
	D2N092	Open cabinet (with adjustable shelf, with cut-out in right side and left side (middle unit).	900	400	565	401	472







Two W900mm cabinets must be ordered for each W1800mm workstation. DOZ003 metal frame with feet and DOZ001 cabinet top are made to fit combinations of two cabinets only. A cabinet top or shelf unit must be ordered to complete the workstation.



G1: Band A MFC Doors & Carcass		G3: Band A MFC Doors + Band B MFC Carcass							
G2: Band B MFC Doors + Band A MFC Carcass		G4: Band B MFC Doors & Carcass							
	CODE	DESCRIPTION	WIDTH	DEPTH	HEIGHT	G1 (£)	G2 (£)	G3 (£)	G4 (£)
	D1S180	Shelf unit with sliding doors (single-sided)	1800	400	380	461	485	563	586
	D1S181	Shelf unit with sliding doors (two-sided, R/H)	1800	400	380	461	485	563	586
	D1S182	Shelf unit with sliding doors (two-sided, L/H)	1800	400	380	461	485	563	586
	D2S182	Shelf unit with sliding doors and open bottom (single-sided)	1800	400	760	665	683	838	854
	D2S183	Shelf unit with sliding doors (two-sided, R/H)	1800	400	760	863	904	1,035	1,089
	D2S184	Shelf unit with sliding doors (two-sided, L/H)	1800	400	760	863	904	1,035	1,089
	D2DL90	Cabinet with 1 hinged door (not lockable, 1 adjustable shelf) and 2 drawers (bottom drawer for files; with central lock) (L/H)	900	420	565	800	814	877	890
	D2DR90	Cabinet with 1 hinged door (not lockable, 1 adjustable shelf) and 2 drawers (bottom drawer for files; with central lock) (R/H)	900	420	565	800	814	877	890
	D2S090	Cabinet with sliding doors (with lock and 2 adjustable shelves)	900	400	565	610	620	680	692
	D3DL90	Cabinet with 1 hinged door (not lockable, 1 adjustable shelf) and 3 drawers (with central lock) (L/H)	900	420	565	837	848	908	925
	D3DR90	Cabinet with 1 hinged door (not lockable, 1 adjustable shelf) and 3 drawers (with central lock) (R/H)	900	420	565	837	848	908	925
	D2DL91	Cabinet with 1 hinged door (not lockable, 1 adjustable shelf) and 2 drawers (bottom drawer for files; with central lock) (L/H)	900	420	565	800	814	877	890

	CODE	DESCRIPTION	WIDTH	DEPTH	HEIGHT	G1 (£)	G2 (£)	G3 (£)	G4 (£)
	D2DR91	Cabinet with 1 hinged door (not lockable, 1 adjustable shelf) and 2 drawers (bottom drawer for files; with central lock) (R/H)	900	420	565	800	814	877	890
	D2S091	Cabinet with sliding doors (with lock and 2 adjustable shelves)	900	400	565	610	620	680	692
	D3DL91	Cabinet with 1 hinged door (not lockable, 1 adjustable shelf) and 3 drawers (with central lock) (L/H)	900	420	565	837	848	908	925
	D3DR91	Cabinet with 1 hinged door (not lockable, 1 adjustable shelf) and 3 drawers (with central lock) (R/H)	900	420	565	837	848	908	925
	D2DL92	Cabinet with 1 hinged door (not lockable, 1 adjustable shelf) and 2 drawers (bottom drawer for files; with central lock) (L/H)	900	420	565	800	814	877	890
	D2DR92	Cabinet with 1 hinged door (not lockable, 1 adjustable shelf) and 2 drawers (bottom drawer for files; with central lock) (R/H)	900	420	565	800	814	877	890
	D2S092	Cabinet with sliding doors (with lock and 2 adjustable shelves)	900	400	565	610	620	680	692
	D3DL92	Cabinet with 1 hinged door (not lockable, 1 adjustable shelf) and 3 drawers (with central lock) (L/H)	900	420	565	837	848	908	925
	D3DR92	Cabinet with 1 hinged door (not lockable, 1 adjustable shelf) and 3 drawers (with central lock) (R/H)	900	420	565	837	848	908	925
	CODE	DESCRIPTION	WIDTH	DEPTH	HEIGHT	RSP (£)			
	DRZ004	Metal frame with feet for 1800mm wide cabinets unit	1218	335	150	84			
G1: Berta / Bondai		G2: Lucia			G3: Synergy / Velito Presto				
	CODE	DESCRIPTION	WIDTH	DEPTH	HEIGHT	G1 (£)	G2 (£)	G3 (£)	
	D0Z005	Fabric back panel for W900mm cabinet	896	482	22	104	116	165	

	CODE	DESCRIPTION	WIDTH	DEPTH	HEIGHT	RSP (£)
	DNZ029	Cable tray for W1200mm desk	832	145	102	123
	DNZ030	Cable tray for W1400mm desk	1032	145	102	134
	DNZ031	Cable tray for W1600mm desk	1232	145	102	137
	DNZ032	Cable tray for W1800mm desk	1432	145	102	143
	DNZ033	Cable tray for W1200mm desk bench	832	340	102	181
	DNZ034	Cable tray for W1400mm desk bench	1032	340	102	201
	DNZ035	Cable tray for W1600mm desk bench	1232	340	102	215
	DNZ036	Cable tray for W1800mm desk bench	1432	340	102	224
	DNZ037	Cable tray for W1200mm desk with sliding desktop	832	145	102	110
	DNZ038	Cable tray for W1400mm desk with sliding desktop	1032	145	102	119
	DNZ039	Cable tray for W1600mm desk with sliding desktop	1232	145	102	128
	DNZ040	Cable tray for W1800mm desk with sliding desktop	1432	145	102	139

	CODE	DESCRIPTION	WIDTH	DEPTH	HEIGHT	RSP (£)
	DNZ041	Cable tray for W1200mm desk bench with sliding desktops	832	340	102	149
	DNZ042	Cable tray for W1400mm desk bench with sliding desktops	1032	340	102	174
	DNZ043	Cable tray for W1600mm desk bench with sliding desktops	1232	340	102	210
	DNZ044	Cable tray for W1800mm desk bench with sliding desktops	1432	340	102	218
	ZZZ363	Rounded metal desk cable port insert (flap)	322	127	26	92
	ZZZ364	Distributor block, flat GST18i3 (1 IN, 3 OUT)				120
	ZZZ365	Distributor block, flat GST18i3 (1 IN, 5 OUT)				171



Optima

MFC cantilever & panel leg desks

See Optima screens



OPTIMA C

A superb range of twin post cantilever leg desking.

This attractive range includes almost 30 different desk shapes and sizes to fit every situation. Quality 25mm MFC tops and modesty panels in a choice of 8 finishes.

Choose from white, grey or black legs and optional white or grey cable management leg inserts. The smart triple compartment vertical cable trunks simply push into the desk leg. We recommend use with modesty fix cable trays.

OPTIMA PLUS

A versatile range of well priced, traditionally styled panel leg office furniture.

25mm work tops with 2mm edging, solid 25mm leg and modesty panels with 8 MFC finishes to choose from.

Don't miss the complete range of matching Optima pedestals and storage (page 170) and meeting tables (page 130).

[See cable management](#)

Range

Cantilever

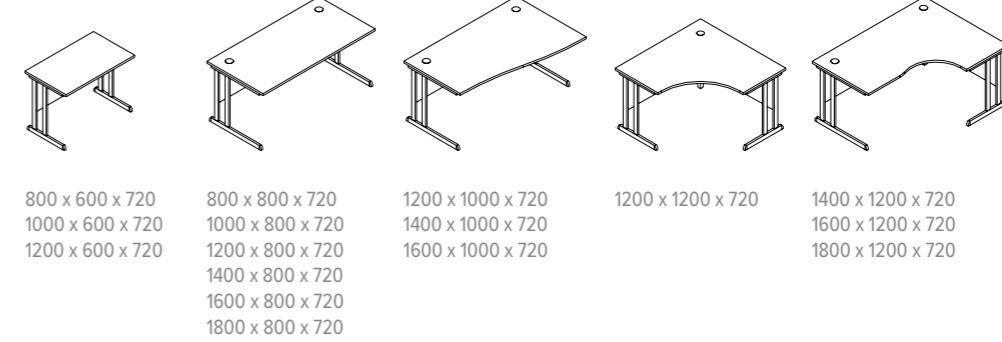

- | | | | | |
|---|---|---|-------------------|---|
| 800 x 600 x 720
1000 x 600 x 720
1200 x 600 x 720 | 800 x 800 x 720
1000 x 800 x 720
1200 x 800 x 720
1400 x 800 x 720
1600 x 800 x 720
1800 x 800 x 720 | 1200 x 1000 x 720
1400 x 1000 x 720
1600 x 1000 x 720 | 1200 x 1200 x 720 | 1400 x 1200 x 720
1600 x 1200 x 720
1800 x 1200 x 720 |
|---|---|---|-------------------|---|

Panel leg

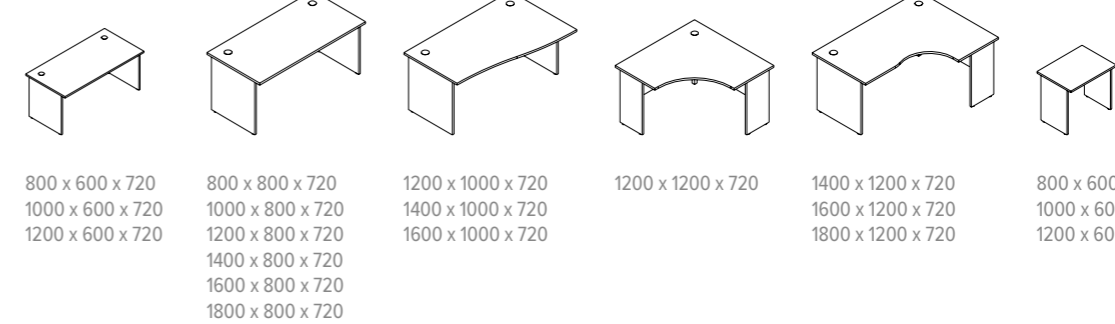

- | | | | | | |
|---|---|---|-------------------|---|---|
| 800 x 600 x 720
1000 x 600 x 720
1200 x 600 x 720 | 800 x 800 x 720
1000 x 800 x 720
1200 x 800 x 720
1400 x 800 x 720
1600 x 800 x 720
1800 x 800 x 720 | 1200 x 1000 x 720
1400 x 1000 x 720
1600 x 1000 x 720 | 1200 x 1200 x 720 | 1400 x 1200 x 720
1600 x 1200 x 720
1800 x 1200 x 720 | 800 x 600 x 720
1000 x 600 x 720
1200 x 600 x 720 |
|---|---|---|-------------------|---|---|

Technical details

Desktops

- 25mm MFC with 2mm ABS edging

Modesty panels

- 25mm MFC with 0.5mm ABS edging

Cantilever legs

- Powder coated welded metal tube (base 50 x 25 mm)
- Plastic height levelling feet (+10mm)

Supplementary unit legs

- Ø50mm powder coated metal tube
- Plastic height levelling feet (+10mm)

Panel legs

- 25mm MFC with 2 mm ABS edging
- Plastic height levelling feet (+10mm)

Fittings for assembly

- Cams with connecting bolts

Materials

G1: Band A MFC







- Whitened Oak (D1)
- Amber Oak (D2)
- White (M1)
- Pearl Grey (N3)
- Dark Grey (N1)









G2: Band B MFC







- Sand Ash (D3)
- Dark Walnut (D4)
- Grey Wood (D5)
- Cubanit Grey (N2)
- Black (J)



Metal

- Black (A) - *Cantilever only*
- Grey (M)
- White (E) - *Cantilever only*

	CODE	DESCRIPTION	WIDTH	DEPTH	HEIGHT	G1 (£)	G2 (£)
	DCA081	Straight cantilever desk	800	800	720	302	323
	DCA101		1000	800	720	324	345
	DCA121		1200	800	720	349	362
	DCA141		1400	800	720	364	389
	DCA161		1600	800	720	396	410
	DCA181		1800	800	720	418	458
	DCR122	R/H wave 1000 cantilever desk	1200	800/1000	720	381	403
	DCR142		1400	800/1000	720	407	436
	DCR162		1600	800/1000	720	426	466
	DCL122	L/H wave 1000 cantilever desk	1200	800/1000	720	383	404
	DCL142		1400	800/1000	720	407	436
	DCL162		1600	800/1000	720	426	466
	DCR141	R/H crescent cantilever desk	1400	800/1200	720	500	540
	DCR161		1600	800/1200	720	529	569
	DCR181		1800	800/1200	720	560	601
	DCL141	L/H crescent cantilever desk	1400	800/1200	720	500	540
	DCL161		1600	800/1200	720	529	569
	DCL181		1800	800/1200	720	560	601
	DCD081	Cantilever extension	800	600	720	251	263
	DCD101		1000	600	720	267	282
	DCD121		1200	600	720	298	312
	DCB120	Symmetrical corner desk	1200	600/1200	720	459	490

	CODE	DESCRIPTION	WIDTH	DEPTH	HEIGHT	G1 (£)	G2 (£)
	DZC180	180° meeting end, 4 fixed Ø50mm metal pole legs	1600	R 800	720	260	281
	DZC181	180° meeting end, 2 fixed Ø50mm metal pole legs	1600	R 800	720	285	306
	DZC183	180° desk end, 1 fixed Ø50mm metal pole leg	800	R 400	720	113	113
	DZC360	Bubble end for cantilever desk, 2 fixed Ø50mm metal pole legs	1000	1100	720	249	270
	DZC271	270° for 600mm end, 2 fixed Ø50mm metal pole legs	R 600	-	720	283	305
	DZC900	90° link, 2 fixed Ø50mm metal pole legs	R 800	-	720	226	236
	DZC901	90° link, 1 fixed Ø50mm metal pole leg	R 800	-	720	216	227
	OEVC	Smart triple compartment vertical cable trunk, push fits into leg. Recommended to use with modesty fix cable trays White only	100	-	600	8	

	CODE	DESCRIPTION	WIDTH	DEPTH	HEIGHT	G1 (£)	G2 (£)
	DDA081	Straight panel leg desk	800	800	720	263	303
	DDA101		1000	800	720	284	326
	DDA121		1200	800	720	311	349
	DDA141		1400	800	720	326	374
	DDA161		1600	800	720	358	400
	DDA181		1800	800	720	381	450
	DDR122	R/H wave panel leg desk	1200	800/1000	720	345	392
	DDR142		1400	800/1000	720	370	421
	DDR162		1600	800/1000	720	388	457
	DDL122	L/H wave panel leg desk	1200	800/1000	720	346	394
	DDL142		1400	800/1000	720	370	421
	DDL162		1600	800/1000	720	388	457
	DDR141	R/H crescent panel leg desk	1400	800/1200	720	459	512
	DDR161		1600	800/1200	720	484	543
	DDR181		1800	800/1200	720	523	576
	DDL141	L/H crescent panel leg desk	1400	800/1200	720	459	512
	DDL161		1600	800/1200	720	484	543
	DDL181		1800	800/1200	720	523	576
	DDB120	Symmetrical linking corner	1200	600/1200	720	397	438
	DDD082	Panel leg extension, full depth	800	600	720	205	221
	DDD102		1000	600	720	216	243
	DDD122		1200	600	720	249	274

	CODE	DESCRIPTION	WIDTH	DEPTH	HEIGHT	G1 (£)	G2 (£)
	DDD081	Panel leg extension, cut back	800	600	720	206	227
	DDD101		1000	600	720	216	249
	DDD121		1200	600	720	249	281
	DDC360	Bubble end for panel leg desk, 2 fixed Ø50mm metal pole legs	1000	1100	720	229	254

See Optima pedestals



Air

MFC desks



An attractive feature of Air desks is the thin profile metal legs which convey a sense of lightness whilst maintaining stability and durability,

The minimalist form combines different textures and colours and is characterised by progressive structural design that creates a unique style.

[See cable management](#)

Range

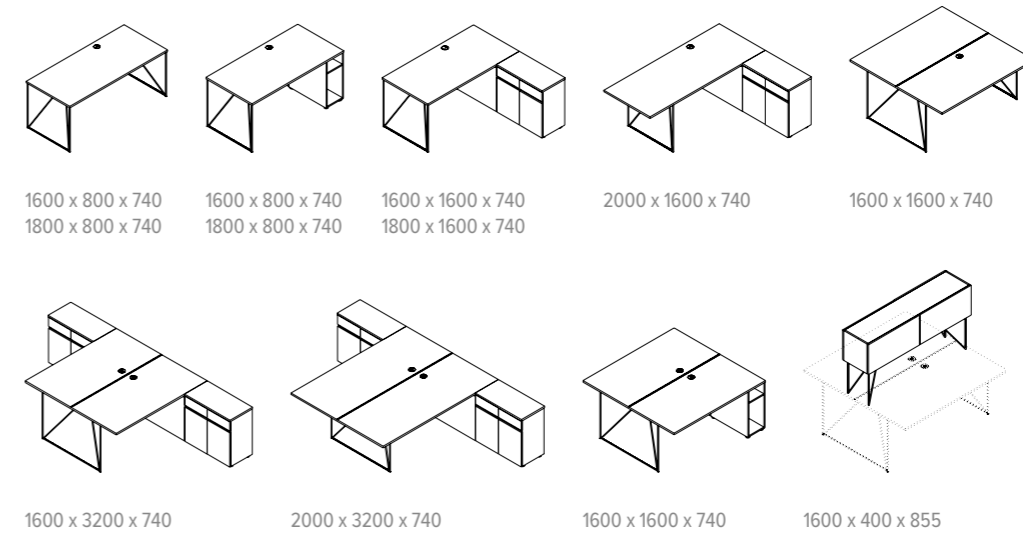

Technical details

Desktop

- 25mm MFC with 2mm ABS edging

Desk Legs

- Powder coated welded metal construction from 12mm tube
- Plastic height levelling feet (+10 mm)

Metal beam (under desktop)

- Metal tube - 40x20 mm and 20x20 mm
- Powder coated metal, colour matches the legs

Desk Cable Port

- Ø80 mm semi-transparent matte plastic in grey outline

Cabinet carcass and shelves

- 18mm MFC with 1mm ABS edging
- Cabinet fixed on 2-desk bench has 0.5mm ABS edging

Cabinet doors

- 18mm MFC with 1mm ABS edging
- Handleless doors with aluminium profile in between for easy opening
- Cabinet fixed on 2-desk bench has no handles

Fixed cabinet fittings

- Cams with connecting bolts
- Fast assembling hinges (no tools required to connect hinges and plates)
- Cabinet fixed on 2-desk bench has gas spring and soft closing

Fixed cabinet plastic legs

- Black plastic height levelling feet, H23mm (+10 mm)

Metal supports on cabinet fixed on 2 desk bench

- Powder coated welded 12mm metal tube

Materials

Band A MFC

- Whitened Oak (D1)
- Amber Oak (D2)
- White (M1)
- Dark Grey (N1)
- Pearl Grey (N3)



Dark Grey (N1) is not available on desktops

Band B MFC



- Sand Ash (D3)
- Dark Walnut (D4)
- Grey Wood (D5)
- Cubanit Grey (N2)
- Black (J4)

Frame Metal



- Black (A)
- Grey (M)
- White (E)

		G1: Band A MFC		G2: Band B MFC			
	CODE	DESCRIPTION	WIDTH	DEPTH	HEIGHT	G1 (£)	G2 (£)
	DIA160	Desk	1600	800	740	751	797
	DIA180		1800	800	740	792	842
	DIA163	Desk with cable port	1600	800	740	749	782
	DIA183		1800	800	740	801	840
	DIS160	2 desk bench with cable ports and aluminium screen groove	1600	1600	740	1,539	1,754

G1: Band A MFC Desktop & Storage
 G2: Band B MFC Desktop + Band A MFC Storage
 G3: Band A MFC Desktop + Band B MFC Storage
 G4: Band B MFC Desktop & Storage

	CODE	DESCRIPTION	WIDTH	DEPTH	HEIGHT	G1 (£)	G2 (£)	G3 (£)	G4 (£)
	DIA162	Desk with cable flap and L/H open cupboard with 1 shelf	1600	800	740	840	867	868	892
	DIA182		1800	800	740	886	905	913	931
	DIA161	Desk with cable port and R/H open cupboard with 1 shelf	1600	1800	740	840	867	868	892
	DIA181		1800	800	740	886	905	913	931
	DIS164	2 desk bench with cable ports, aluminum screen groove and open cupboards with 1 shelf	1600	1600	740	1,424	1,478	1,493	1,531

G1: Band A MFC Desktop, Storage & Doors
 G2: Band B MFC Desktop & Storage + Band A MFC Doors
 G3: Band A MFC Desktop & Storage + Band B MFC Doors
 G4: Band B MFC Desktop, Storage & Doors

	CODE	DESCRIPTION	WIDTH	DEPTH	HEIGHT	G1 (£)	G2 (£)	G3 (£)	G4 (£)
	DIS161	Desk with cable port and L/H cabinet (2 drawers without lock, 2 shelves; 1 shelf under the desktop)	1600	1600	740	1,889	1,921	1,984	2,016
	DIS180		1800	1600	740	1,935	1,961	2,032	2,056
	DIS163	Desk with cable flaps and R/H cabinet (2 drawers without lock, 2 shelves; 1 shelf under the desktop)	1600	1600	740	1,889	1,921	1,984	2,016
	DIS181		1800	1600	740	1,935	1,961	2,032	2,056
	DIS201	Desk with extended top, cable port and L/H cabinet (2 drawers without lock, 2 shelves; 1 shelf under the desktop)	2000	1600	740	1,898	1,987	2,083	2,083
	DIS203	Desk with extended top, cable port and R/H cabinet (2 drawers without lock, 2 shelves; 1 shelf under the desktop)	2000	1600	740	1,898	1,987	2,083	2,083
	DIS162	2 desk bench with cable ports, aluminum screen groove and 2 cabinets (each with 2 drawers without lock, 2 shelves; 1 shelf under the desktop)	1600	3200	740	3,546	3,583	3,737	3,775
	DIS202	2-desk bench with extended top, cable ports for wire management, aluminum screen groove and 2 cabinets (each with 2 drawers without lock, 2 shelves; 1 shelf under the desktop)	2000	3200	740	3,779	3,957	3,968	4,146

G1: Band A MFC Storage & Doors
 G2: Band B MFC Storage + Band A MFC Doors
 G3: Band A MFC Storage + Band B MFC Doors
 G4: Band B MFC Storage & Doors

	CODE	DESCRIPTION	WIDTH	DEPTH	HEIGHT	G1 (£)	G2 (£)	G3 (£)	G4 (£)
	DIE200	Cabinet placed on bench (2 desks)	1600	400	855	842	888	893	936

	CODE	DESCRIPTION	WIDTH	DEPTH	HEIGHT	RSP (£)
--	------	-------------	-------	-------	--------	---------

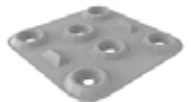
	ZIZ001	Fittings for desktop connection (2 pcs)	-	-	-	21
---	--------	---	---	---	---	----

	DIK131	White Plexiglas® desktop divider screen for W1600mm / W2000mm back-to-back benches	1300	-	314 (300)	212
--	--------	--	------	---	-----------	-----

	DIK130	White Plexiglas® modesty panel for W1600mm / W2000mm desks	1300	-	300	210
---	--------	--	------	---	-----	-----



See Air meeting tables



Alto

Two & three stage standing desks & bench desks

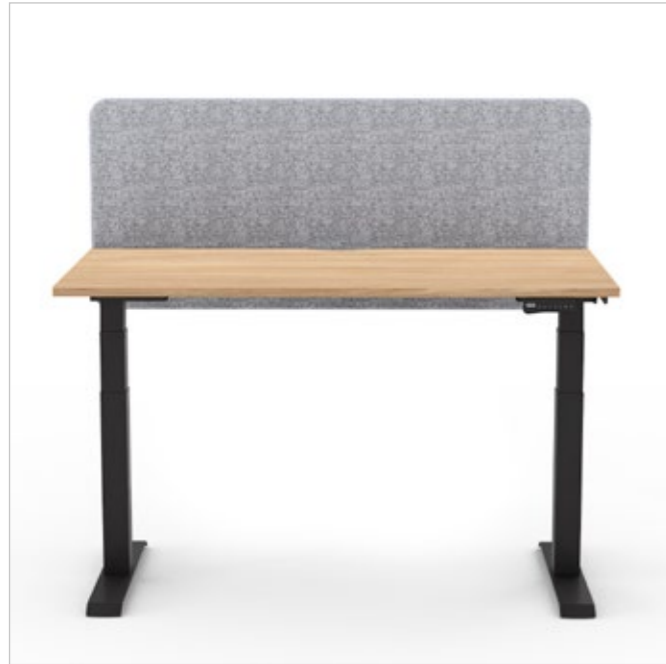

Advanced anti-collision with adjustable sensitivity on Alto 2

Our Alto standing desk range makes ergonomic height adjustable working an affordable prospect.

Alto 1 offers an economical standing solution to your workspace with a quiet motor providing smooth height adjustment and a simple, easy-to-use control panel.

Alto 2 provides all you need in a height adjustable workstation, packed full of features including powerful twin motors for fast height adjustment and an advanced anti-collision system with adjustable sensitivity.

Easily save your most comfortable working positions with 3 height memory presets, the handy reminder function will notify you when it's time to switch position! Multiple desktop finishes are available to match the Alto desks to your existing desking.

The Alto 2 back-to-back bench desk includes all the premium features of the Alto 2 single desk with the addition of optional universal screen brackets and an optional adjustable central cable tray.

[See cable management](#)

Technical details

Alto 1 Desk

Two stage frame

- 2 reversed rectangular columns
- Finishes: Black / White / Grey
- Height range: 710-1210 mm
- Stroke length: 500mm
- Load capacity: 154lbs / 70kg
- Desktop width 1000-1600 mm
- Desktop depth 500-800 mm

Single Motor

- Anti-collision system
- Motor speed 25mm/s
- Power 100-240 v
- Sound level <50dB

Control panel

- Height adjustment (up/down)

EU power cable available

Warranty: 5 years

Alto 2 Desk

Three stage frame

- 3 holeless square columns
- Integrated cable tidy
- Finishes: Black / White / Grey
- Height range: 580-1230 mm
- Stroke length: 650mm
- Load capacity: 275lbs / 125kg
- Desktop width 1100-1900 mm
- Desktop depth 700 or 800 mm

Twin/Dual Motor

- Advanced anti-collision system
- Motor speed: 38mm/s
- Power 100v-240v
- Sound level: <50dB

Control panel

- Height adjustment
- 3 height memory presets
- Height display
- Reminder timer function

EU power cable available

Warranty: 5 years

Alto 2 Bench

Three stage frame

- 3 holeless square columns
- Optional cable tray
- Optional divider screen brackets
- Finishes: Black / White
- Height range: 580-1230 mm
- Stroke length: 650mm
- Load capacity: 275lbs / 125kg
- Desktop width 1100-1900 mm
- Desktop depth 700 or 800 mm

Twin/Dual Motor

- Advanced anti-collision system
- Motor speed: 38mm/s
- Power 100v-240v
- Sound level: <50dB

Control panel

- Height adjustment
- 3 height memory presets
- Height display
- Reminder timer function

EU power cable available

Warranty: 5 years

[Watch the video](https://youtu.be/mbElnf0vmCM)
youtu.be/mbElnf0vmCM









Materials

- G1: Band A MFC**
Whitened Oak (D1)
Amber Oak (D2)
White (M1)
Pearl Grey (N3)

- G2: Band B MFC**
Sand Ash (D3)
Dark Walnut (D4)
Grey Wood (D5)
Cubanit Grey (N2)



- Frame Metal**
Black (BK)
White (WH)
Grey (SV) - *Single desks only*





	CODE	DESCRIPTION	TOP WIDTH	TOP DEPTH	HEIGHT	RSP (£)
	HAFS121	Alto 1 two stage electric height adjustable desk with reversed rectangular columns and single motor	1000-1600	500-800	710-1210	672
	HAFD121	Alto 1 back-to-back 2-desk bench	1000-1600	500-800	710-1210	1444
	HAFS233	Alto 2 three stage electric height adjustable desk with holeless square columns and twin motors	1100-1900	700 or 800	580-1230	1061
	HAFD233	Alto 2 three stage electric height adjustable back-to-back bench with holeless square columns and twin motors	1100-1900	700 or 800	580-1230	2232
	HAFD2-CT	Optional adjustable central cable tray for back-to-back bench (HAFD233), D230 x H80	Adjustable	-	-	279
	HAFD2-LT	Connecting cable tidy spacer, to connect multiple Alto 2 back-to-back benches	-	-	-	59

G1: Berta / Bondai		G2: Lucia		G3: Velito Presto / Step/Step Melange / Synergy				
	CODE	DESCRIPTION	WIDTH	DEPTH	HEIGHT	G1 (£)	G2 (£)	G3 (£)
	G4A153	Fabric screen <i>(brackets must be ordered separately)</i>	1200	22	750	190	299	323
	G4A154		1400	22	750	229	350	384
	G4A249		1600	22	750	252	397	436
	G4A155		1800	22	750	287	441	486

G1: Berta		G2: Lucia		G3: Velito Presto / Step/Step Melange / Synergy				
	CODE	DESCRIPTION	WIDTH	DEPTH	HEIGHT	G1 (£)	G2 (£)	G3 (£)
	G4E033	Double-sided fabric screen <i>(brackets must be ordered separately)</i>	1200	42	740	215	281	329
	G4E015		1400	42	740	234	296	339
	G4E016		1600	42	740	270	341	385
	G4E034		1800	42	740	443	558	633

Optional EU power cables available: for Alto 1 with type E/F plug or Alto 2 with type C plug.
Not every fabric from these ranges is available on Narbutas products - please see Fabrics section at back of price list for details

	CODE	DESCRIPTION	WIDTH	DEPTH	HEIGHT	RSP (£)
	G6F272	Brackets for mounting G4A rounded screens on Alto single desks, fixed screen height (2 pcs.)	-	-	-	20
	G6F184	Brackets for mounting G4E double-sided screens on Alto single desks, adjustable screen height (2 pcs.)	-	-	-	79
	HAFD2-SB	Brackets for mounting G4E and G4A screens on Alto 2 back-to-back bench desks (HAFD233) (2 pcs.)	-	-	-	48

		G1: Band A MFC			G2: Band B MFC		
	CODE	DESCRIPTION	TOP WIDTH	TOP DEPTH	HEIGHT	G1 (£)	G2 (£)
	HAT127S	Desktop with scoop back	1200	700	25	165	294
	HAT147S		1400	700	25	182	302
	HAT167S		1600	700	25	208	311
	HAT187S		1800	700	25	257	350
	HAT128S	Desktop with straight back	1200	800	25	181	298
	HAT148S		1400	800	25	203	306
	HAT168S		1600	800	25	225	316
	HAT188S		1800	800	25	262	359
	HAT127C	Desktop with cable port cutout <i>Cable port insert (ZNZ010) must be ordered</i>	1200	700	25	211	294
	HAT147C		1400	700	25	232	302
	HAT167C		1600	700	25	258	311
	HAT187C		1800	700	25	328	350
	HAT128C	Desktop with cable port cutout <i>Cable port insert (ZNZ010) must be ordered</i>	1200	800	25	211	298
	HAT148C		1400	800	25	237	306
	HAT168C		1600	800	25	258	316
	HAT188C		1800	800	25	337	359

Motion

Two & three stage standing bench desks



Compatible with Modus screens

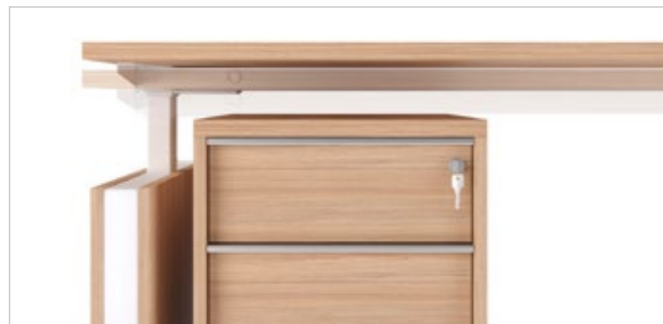

The Motion system offers electric height adjustable bench desks designed for a flexible arrangement of workstations and a more dynamic working environment, available as single desks or bench desks.

You can adjust the height of the desk with a touch of a button or via Bluetooth remote control from your smartphone.

The control panel also offers a reminder to alternate between sitting and standing positions and includes an anti-collision feature to avoid items getting trapped under the desk, the 3 level feet sensor will automatically stop the desk's movement if it senses an obstacle in its path.

[See cable management](#)

Range

Legs

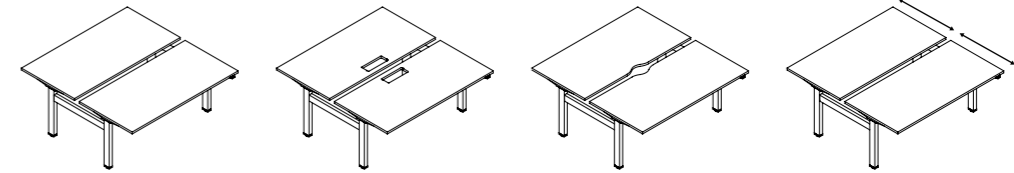

1 panel leg

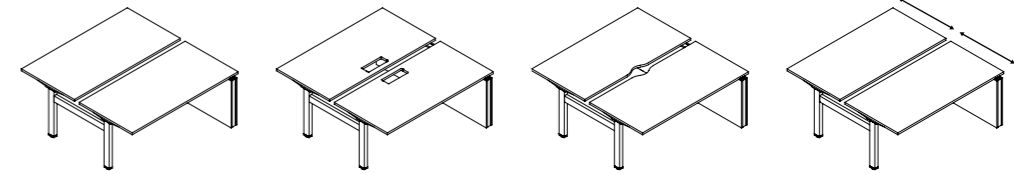

2 panel legs

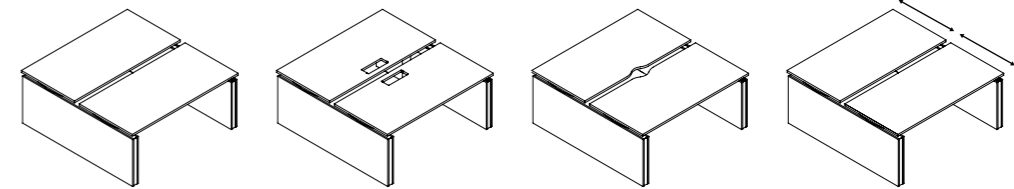

1400 x 1674 x 700-1200
1600 x 1674 x 700-1200
1400 x 1674 x 650-1300
1600 x 1674 x 650-1300

1400 x 1674 x 700-1200
1600 x 1674 x 700-1200
1400 x 1674 x 650-1300
1600 x 1674 x 650-1300

1400 x 1674 x 700-1200
1600 x 1674 x 700-1200
1400 x 1674 x 650-1300
1600 x 1674 x 650-1300

1400 x 1674 x 700-1200
1600 x 1674 x 700-1200
1400 x 1674 x 650-1300
1600 x 1674 x 650-1300

Technical details

Desktop

- 25mm MFC with 2mm ABS edging
- 80mm gap between bench desktops

Frame

- 60 x 45 x 460 mm L-shaped angle
- 40 x 20 mm powder coated metal tube, matches the colour of columns

Lifting columns

- 2 or 3 stage columns
- Anti-collision feature included with 3 stage columns available for 2 stage columns with ZZZ372 sensor
- Twin motors with soft start and soft stop
- Up to 38mm/sec lifting speed
- Stroke length: 2 stage: 500mm, 3 stage: 650mm
- 50 x 80 mm rectangular tube
- Up to 80kg lifting capacity
- Powder coated metal, matches the colour of frame
- Column levellers up to 10mm
- MFC side column covers, colour combinations possible

Electronic data power unit

- Input: 230V (or 120V for US)
- Frequency: 50Hz (or 60Hz for US)
- Output: 12 - 40 V, 9A
- Option of UK, EU or CH type power cable
- Energy consumption: standby 0.1W
- Operating cycle: 1 minute on / 9 minutes off

Connecting component (DOZ008)

- 2 metal components, assemble without screws
- Matches the colour of columns and frame
- 30mm distance between desktops, 85mm distance between columns

Desk control button types

- BA / TA / TE: Up and down adjustment
- MA: Up and down adjustment and 3 memory position
- LA: Up and down adjustment, 2 memory positions, LED reminder, integrated Bluetooth

Screens

- Frame made of 18x80 mm MDF
- Central layer of 20mm open-cell foam made of melamine resin (BASOTECT G+)
- Second layer is made of VB3842 10mm foam both sides
- Third layer is made of VB2240 3mm foam both sides
- Dowel pins combine two panels
- Fittings are knocked in to the screen
- Attaches to the cable tray holder

Materials

Band A MFC

Whitened Oak (D1)
Amber Oak (D2)
White (M1)
Pearl Grey (N3)
Dark Grey (N1)

Band B MFC

Sand Ash (D3)
Dark Walnut (D4)
Grey Wood (D5)
Cubanit Grey (N2)
Black (J4)







Frame Metal

Black (A)
Grey (M)
White (E)









Screen Fabric*

Berta
Lucia
Velito Presto
Synergy
Step/Step Melange

G1: Band A MFC + Control type BA / TA / TE
G2: Band A MFC + Control type LA / MA
G3: Band B MFC + Control type BA / TA / TE
G4: Band B MFC + Control type LA / MA







	CODE	DESCRIPTION	WIDTH	DEPTH	HEIGHT	G1 (£)	G2 (£)	G3 (£)	G4 (£)
	DOA140	2 stage electric height adjustable desk with panel legs and straight back	1400	800	700-1200	2,129	2,200	2,202	2,272
	DOA160		1600	800	700-1200	2,134	2,183	2,216	2,284
	DOA180		1800	800	700-1200	2,215	2,291	2,300	2,375
	DOA141	2 stage electric height adjustable desk with panel legs and cable port cutout*	1400	800	700-1200	2,134	2,183	2,216	2,284
	DOA161		1600	800	700-1200	2,164	2,239	2,235	2,311
	DOA181		1800	800	700-1200	2,215	2,291	2,300	2,375
	DOA142	2 stage electric height adjustable desk with panel legs and scoop back	1400	800	700-1200	2,115	2,207	2,216	2,284
	DOA162		1600	800	700-1200	2,164	2,239	2,241	2,319
	DOA182		1800	800	700-1200	2,220	2,297	2,305	2,381
	DOS140	2 stage electric height adjustable 2 desk bench with straight back	1400	1680	700-1200	3,691	3,793	3,837	3,940
	DOS160		1600	1680	700-1200	3,743	3,833	3,891	3,980
	DOS180		1800	1680	700-1200	3,872	3,993	4,018	4,140
	DOS141	2 stage electric height adjustable 2 desk bench with cable port cutouts*	1400	1680	700-1200	3,699	3,813	3,844	3,959
	DOS161		1600	1680	700-1200	3,763	3,865	3,909	4,011
	DOS181		1800	1680	700-1200	3,866	3,993	4,012	4,140
	DOS142	2 stage electric height adjustable 2 desk bench with scoop back	1400	1680	700-1200	3,701	3,814	3,846	3,960
	DOS162		1600	1680	700-1200	3,763	3,877	3,909	4,023
	DOS182		1800	1680	700-1200	3,879	4,006	4,023	4,151

* Cable port insert (ZNZ010) must be ordered









	CODE	DESCRIPTION	WIDTH	DEPTH	HEIGHT	G1 (£)	G2 (£)	G3 (£)	G4 (£)
	DOS143	2 stage electric height adjustable 2 desk bench with sliding desktop and straight back	1400	1680	700-1200	3,781	3,883	3,926	4,028
	DOS163		1600	1680	700-1200	3,825	3,926	3,971	4,072
	DOS144	2 stage electric height adjustable 2-desk bench with one open metal leg, one panel leg and straight back	1400	1680	700-1200	3,597	4,011	4,156	4,302
	DOS164		1600	1680	700-1200	4,056	4,190	4,202	4,335
	DOS184		1800	1680	700-1200	4,183	4,330	4,349	4,494
	DOS145	2 stage electric height adjustable 2-desk bench with one open metal leg, one panel leg and cable port cutouts*	1400	1680	700-1200	4,010	4,156	4,169	4,314
	DOS165		1600	1680	700-1200	4,074	4,222	4,222	4,367
	DOS185		1800	1680	700-1200	4,184	4,330	4,349	4,495
	DOS146	2 stage electric height adjustable 2-desk bench with one open metal leg, one panel leg and scoop back	1400	1680	700-1200	4,012	4,157	4,171	4,316
	DOS166		1600	1680	700-1200	4,074	4,222	4,234	4,380
	DOS186		1800	1680	700-1200	4,197	4,342	4,361	4,509
	DOS147	2 stage electric height adjustable 2-desk bench with one open metal leg, one panel leg, sliding desktop and straight back	1400	1680	700-1200	3,926	4,092	4,237	4,383
	DOS167		1600	1680	700-1200	3,971	4,137	4,283	4,428
	DOS148	2 stage electric height adjustable 2-desk bench with panel legs and straight back	1400	1680	700-1200	4,322	4,468	4,512	4,659
	DOS168		1600	1680	700-1200	4,367	4,514	4,545	4,692
	DOS188		1800	1680	700-1200	4,495	4,641	4,712	4,857
	DOS149	2 stage electric height adjustable 2-desk bench with panel legs and cable port cutouts*	1400	1680	700-1200	4,322	4,474	4,524	4,671
	DOS169		1600	1680	700-1200	4,387	4,533	4,578	4,722
	DOS189		1800	1680	700-1200	4,495	4,641	4,706	4,851
	DOS14A	2 stage electric height adjustable 2-desk bench with panel legs and scoop back	1400	1680	700-1200	4,324	4,476	4,527	4,672
	DOS16A		1600	1680	700-1200	4,387	4,533	4,589	4,737
	DOS18A		1800	1680	700-1200	4,509	4,654	4,718	4,864
	DOS14B	2 stage electric height adjustable 2-desk bench with panel legs, sliding desktop and straight back	1400	1680	700-1200	4,409	4,556	4,600	4,747
	DOS16B		1600	1680	700-1200	4,449	4,593	4,638	4,784

* Cable port insert (ZNZ010) must be ordered

G1: Band A MFC + Control type BA / TA / TE
 G2: Band A MFC + Control type LA / MA
 G3: Band B MFC + Control type BA / TA / TE
 G4: Band B MFC + Control type LA / MA

	CODE	DESCRIPTION	WIDTH	DEPTH	HEIGHT	G1 (£)	G2 (£)	G3 (£)	G4 (£)
	DOA143	3 stage electric height adjustable desk with panel legs and straight back	1400	800	650-1300	2,244	2,320	2,332	2,402
	DOA163		1600	800	650-1300	2,270	2,339	2,346	2,422
	DOA183		1800	800	650-1300	2,333	2,403	2,429	2,505
	DOA144	3 stage electric height adjustable desk with panel legs and cable port cutout*	1400	800	650-1300	2,247	2,323	2,335	2,412
	DOA164		1600	800	650-1300	2,282	2,352	2,364	2,435
	DOA184		1800	800	650-1300	2,333	2,403	2,429	2,498
	DOA145	3 stage electric height adjustable desk with panel legs and scoop back	1400	800	650-1300	2,248	2,324	2,336	2,413
	DOA165		1600	800	650-1300	2,282	2,352	2,371	2,441
	DOA185		1800	800	650-1300	2,340	2,409	2,435	2,505
	DOS14C	3 stage electric height adjustable 2 desk bench with straight back	1400	1680	650-1300	3,935	4,079	4,036	4,181
	DOS16C		1600	1680	650-1300	3,980	4,125	4,069	4,215
	DOS18C		1800	1680	650-1300	4,107	4,253	4,228	4,373
	DOS14D	3 stage electric height adjustable 2 desk bench with cable port cutouts*	1400	1680	650-1300	3,934	4,079	4,048	4,194
	DOS16D		1600	1680	650-1300	3,998	4,144	4,100	4,247
	DOS18D		1800	1680	650-1300	4,107	4,254	4,228	4,373
	DOS14E	3 stage electric height adjustable 2 desk bench with scoop back	1400	1680	650-1300	3,936	4,081	4,049	4,196
	DOS16E		1600	1680	650-1300	3,998	4,144	4,113	4,258
	DOS18E		1800	1680	650-1300	4,120	4,267	4,240	4,386
	DOS14F	3 stage electric height adjustable 2 desk bench with sliding desktop and straight back	1400	1680	650-1300	4,016	4,167	4,116	4,262
	DOS16F		1600	1680	650-1300	4,060	4,205	4,162	4,307

* Cable port insert (ZNZ010) must be ordered

	CODE	DESCRIPTION	WIDTH	DEPTH	HEIGHT	G1 (£)	G2 (£)	G3 (£)	G4 (£)
	DOS14G	3 stage electric height adjustable 2-desk bench with one open metal leg, one panel leg and straight back	1400	1680	650-1300	4,238	4,385	4,372	4,517
	DOS16G		1600	1680	650-1300	4,285	4,431	4,412	4,557
	DOS18G		1800	1680	650-1300	4,412	4,559	4,571	4,717
	DOS14H	3 stage electric height adjustable 2-desk bench with one open metal leg, one panel leg and cable port cutouts*	1400	1680	650-1300	4,244	4,390	4,390	4,536
	DOS16H		1600	1680	650-1300	4,309	4,456	4,442	4,589
	DOS18H		1800	1680	650-1300	4,412	4,559	4,571	4,717
	DOS14J	3 stage electric height adjustable 2-desk bench with one open metal leg, one panel leg and scoop back	1400	1680	650-1300	4,247	4,391	4,391	4,538
	DOS16J		1600	1680	650-1300	4,309	4,456	4,456	4,602
	DOS18J		1800	1680	650-1300	4,425	4,571	4,584	4,729
	DOS14K	3 stage electric height adjustable 2-desk bench with one open metal leg, one panel leg, sliding desktop and straight back	1400	1680	650-1300	4,327	4,472	4,460	4,606
	DOS16K		1600	1680	650-1300	4,365	4,511	4,505	4,650
	DOS14L	3 stage electric height adjustable 2-desk bench with panel legs and straight back	1400	1680	650-1300	4,550	4,696	4,715	4,861
	DOS16L		1600	1680	650-1300	4,596	4,741	4,748	4,895
	DOS18L		1800	1680	650-1300	4,722	4,871	4,914	5,060
	DOS14M	3 stage electric height adjustable 2-desk bench with panel legs and cable port cutouts*	1400	1680	650-1300	4,548	4,696	4,734	4,880
	DOS16M		1600	1680	650-1300	4,615	4,762	4,786	4,932
	DOS18M		1800	1680	650-1300	4,724	4,871	4,914	5,060
	DOS14N	3 stage electric height adjustable 2-desk bench with panel legs and scoop back	1400	1680	650-1300	4,552	4,697	4,736	4,881
	DOS16N		1600	1680	650-1300	4,615	4,762	4,799	4,946
	DOS18N		1800	1680	650-1300	4,737	4,882	4,927	5,072
	DOS14P	3 stage electric height adjustable 2-desk bench with panel legs, sliding desktop and straight back	1400	1680	650-1300	4,631	4,777	4,803	4,949
	DOS16P		1600	1680	650-1300	4,676	4,822	4,842	4,987

* Cable port insert (ZNZ010) must be ordered

Motion screens can be upholstered in a different colour on each side, however it must be from the same fabric range. APZ001 must be ordered if central cable tray is not ordered.

G1: Berta
G2: Lucia
G3: Velito Presto / Synergy / Step/Step Melange

	CODE	DESCRIPTION	WIDTH	DEPTH	HEIGHT	G1 (£)	G2 (£)	G3 (£)
	APK140	Desktop screen for W1400mm single desk	1400	42	740 (660)	400	481	542
	APK160	Desktop screen for W1600mm single desk	1600	42	740 (660)	449	541	602
	APK180	Desktop screen for W1800mm single desk	1800	42	740 (660)	678	820	918
	APK141	Double sided acoustic screen (class C) for W1400mm 2 stage bench	1400	42	600 (515)	368	448	490
	APK161	Double sided acoustic screen (class C) for W1600mm 2 stage bench	1600	42	600 (515)	390	476	526
	APK181	Double sided acoustic screen (class C) for W1800mm 2 stage bench	1800	42	600 (515)	436	529	597
	APK143	Double sided acoustic screen (class C) for W1400mm 2 stage bench	1400	46	600 (515)	392	472	527
	APK163	Double sided acoustic screen (class C) for W1600mm 2 stage bench	1600	46	600 (515)	426	519	581
	APK183	Double sided acoustic screen (class C) for W1800mm 2 stage bench	1800	46	600 (515)	732	893	999
	APK142	Double sided acoustic screen (class C) for W1400mm 3 stage bench	1400	42	740 (660)	419	505	560
	APK162	Double sided acoustic screen (class C) for W1600mm 3 stage bench	1600	42	740 (660)	619	761	854
	APK182	Double sided acoustic screen (class C) for W1800mm 3 stage bench	1800	42	740 (660)	708	868	968
	APK144	Double sided acoustic screen (class C) for W1400mm 3 stage bench	1400	46	740 (660)	461	565	634
	APK164	Double sided acoustic screen (class C) for W1600mm 3 stage bench	1600	46	740 (660)	650	798	891
	APK184	Double sided acoustic screen (class C) for W1800mm 3 stage bench	1800	46	740 (660)	874	1,084	1,208



Height in brackets is screen height above the desktop, with the desktop at its lowest position.

	CODE	DESCRIPTION	WIDTH	DEPTH	HEIGHT	RSP (£)
	DOZ008	Set of desks connecting components	230	30	60	47
	DOZ010	Central cable tray for W1400mm desk/bench - attached to the leg's connection	1200	140	76	151
	DOZ011	Central cable tray for W1600mm desk/bench - attached to the leg's connection	1400	140	76	184
	DOZ012	Central cable tray for W1800mm desk/bench - attached to the leg's connection	1600	140	76	191
	APZ001	Brackets for screen (required if central cable tray is not ordered)	62	60	128	66



Reception

Reception desks

Reception panels



Domino reception desk

Domino

Reception desk system

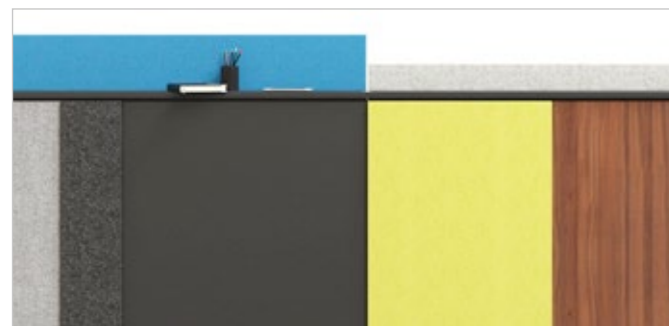

Domino is a unique piece of furniture that will enable you to create workplace solutions tailored to your needs.

A large choice of fabrics, colours and sizes offers an endless range of combinations. The Domino base is available in 9 different options and acts as a base for matching different colours and textures. 2 available thicknesses of exterior panels (18mm and 31mm) adds character to the pattern being created.

Panels are available in a choice of melamine, natural veneer, or upholstered in a range of fabrics.

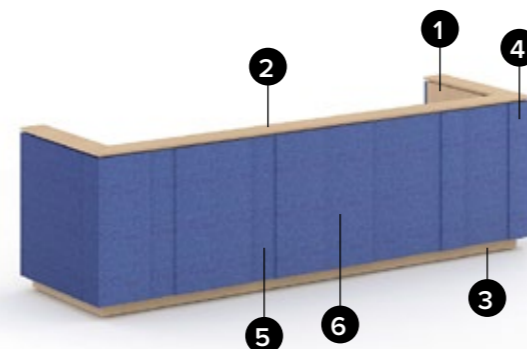

Range

'U' shape

H1100mm

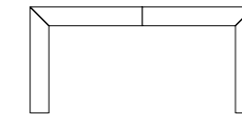

2200x1040 (1x1800mm desk)

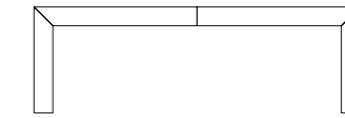

3200x1040 (2x1400mm desk)

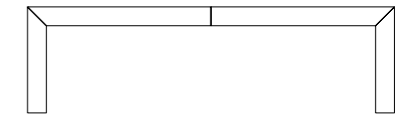

3600x1040 (2x1600mm desk)

'L' shape

H1100mm

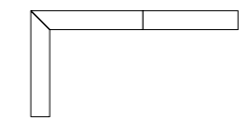

2000x1040 (1x1800mm desk)

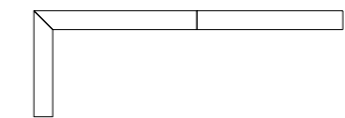

3000x1040 (2x1400mm desk)

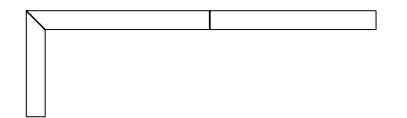

3400x1040 (2x1600mm desk)

Front panels

Thickness 18/31mm, H972mm



200mm



400mm



600mm



800mm

Technical details

1. Back/inside panel unit

- 18mm chipboard pressed with melamine or 19mm chipboard pressed with veneer

2. Top of upper unit

- 18mm chipboard pressed with melamine with 2mm ABS edges or 19mm chipboard pressed with veneer with 1.5mm edges
- Assembled with a 12mm chipboard support

3. Plinth base

- Exterior part (front and side facades) 18mm chipboard pressed with melamine or veneer

FRONT & SIDE FACADES

4. Side fabric panel (31mm)

- Made of 25mm chipboard
- VB2240 foam (3 mm)

5. Front fabric or solid panel (18mm)

- 12mm chipboard pressed with veneer or melamine, or upholstered with fabric
- 3mm VB2240 foam is used on fabric upholstered panel

6. Front fabric panel (31mm)

- 25mm chipboard with 3mm VB2240 foam

Wire cover cap (black only)

- U shape: 4pcs. included
- L shape: 2pcs. included

Materials

Band A MFC

- Whitened Oak (D1)
- Amber Oak (D2)
- White (M1)
- Pearl Grey (N3)
- Dark Grey (N1)

Band B MFC

- Sand Ash (D3)
- Dark Walnut (D4)
- Grey Wood (D5)
- Cubanit Grey (N2)
- Black (J4)

Band A Veneer

- Oak (AA)
- Ash stained Black (N61)
- Walnut (RR)
- Ash (V1)

Band B Veneer

- Ash stained Dark Brown (N62)
- Walnut stained Grey (N63)

Fabric*

- Step/Step Melange
- Velito
- Camira Synergy
- Gabriel Cyber

* Not every fabric from these ranges is available on Narbutas products - please see Fabrics section at back of price list for details

Ordering example

Step 1: Choose carcass shape (U or L shape) and sizes (from 3 available sizes)



Step 2: Choose side fabric panels

RMK200 + RMK200 or RMK400 + RMK400 is not possible

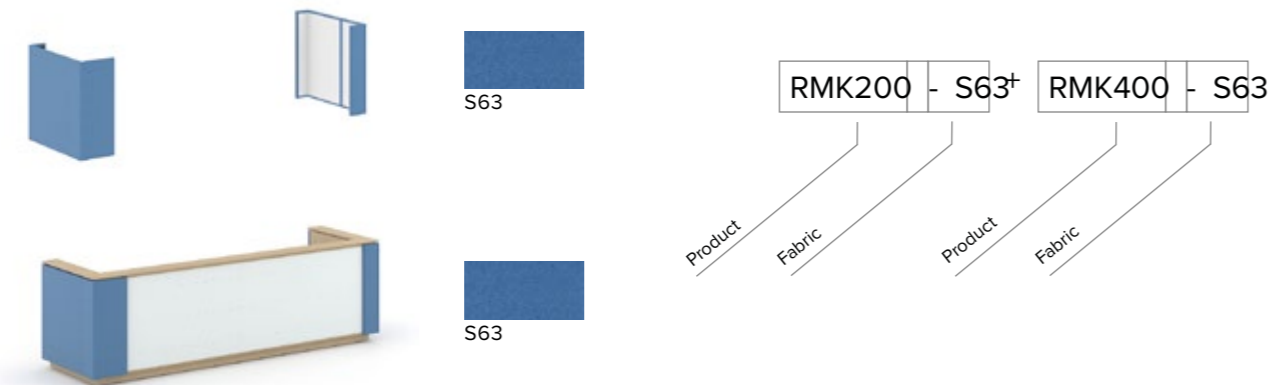

Step 3: Choose a set of front panels

Required front panel set length for RMS360 (2 desks x 1600mm) is 3000 mm



- ① RMP202 – N1
- ② RMP601 – S63
- ③ RMP202 – D4
- ④ RMP401 – S16
- ⑤ RMP401 – S17
- ⑥ RMP602 – D2
- ⑦ RMP201 - GP5
- ⑧ RMP400 – S59

To calculate the total width required for the front panels (to fill the space) subtract the depth of the fabric side panels from the total desk width.

eg. RMS360 W3600mm - D400mm (RMK400) - D200mm (RMK200) = W3000 mm	eg. RMS200 W2035mm - D435mm (RMK201) - D200mm (RMK200) = W1400 mm
---	---

Final Product



Panel combination examples

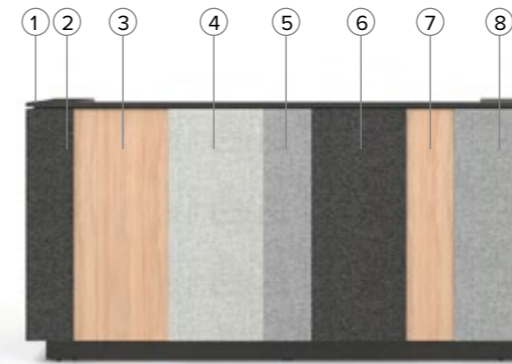

2200mm (1 x 1800 desk)

- ① RMS220 – N1
- ② RMK200 – S17
- ③ RMP202 – D2
- ④ RMP401 – S08
- ⑤ RMP201 – S16
- ⑥ RMP401 – S17
- ⑦ RMP202 – D2
- ⑧ RMK400 – S16

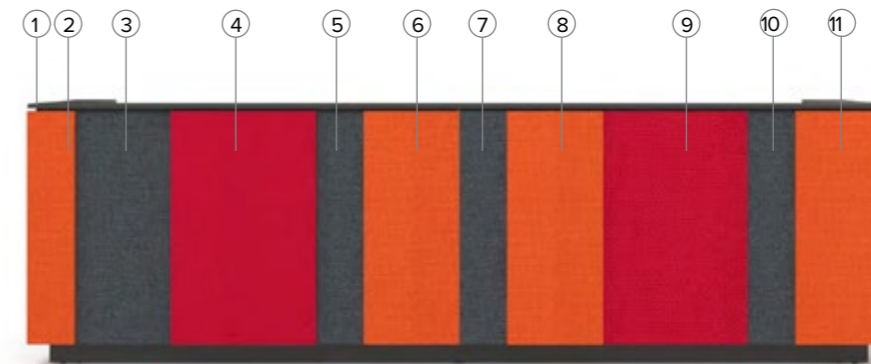

3600mm (2 x 1600 desks)

- ① RMS360 – N1
- ② RMK200 – L11
- ③ RMP400 – L20
- ④ RMP601 – L19
- ⑤ RMP200 – L20
- ⑥ RMP401 – L11
- ⑦ RMP200 – L20
- ⑧ RMP401 – L11
- ⑨ RMP601 – L19
- ⑩ RMP200 – L20
- ⑪ RMK400 – L11



3600mm (2 x 1600 desks)

- ① RMS360 – D2
- ② RMK200 – L14
- ③ RMP400 – L20
- ④ RMP201 – L12
- ⑤ RMP400 – L06
- ⑥ RMP401 – L14
- ⑦ RMP200 – L20
- ⑧ RMP401 – L12
- ⑨ RMP200 – L06
- ⑩ RMP401 – L14
- ⑪ RMP400 – L20
- ⑫ RMK400 – L06

Step 1 U-shape carcass

G1: Band A MFC		G2: Band B MFC			G3: Band A Veneer			G3: Band B Veneer		
	CODE	DESCRIPTION	WIDTH	DEPTH	HEIGHT	G1 (£)	G2 (£)	G3 (£)	G4 (£)	
	RMS220	Reception unit U-shaped carcass (without desks), MFC or veneer top, inner and plinth <i>Requires side and front panels</i>	2200	1040	1100	2,119	2,375	4,430	5,251	
	RMS320		3200	1040	1100	2,652	2,992	5,417	6,652	
	RMS360		3600	1040	1100	2,832	3,184	5,810	6,983	

Step 2 U-shape fabric side panels





(both required)

G1: Step/Step Melange		G2: Velito / Synergy / Cyber							
	CODE	DESCRIPTION	WIDTH	DEPTH	HEIGHT	G1 (£)	G2 (£)		
	RMK400	Fabric side panel for U-shaped reception unit carcass <i>Required</i>	1040	400	972	955	1,205		
	RMK200	Fabric side panel for reception unit carcass <i>Required</i>	1040	200	972	857	1,091		





Step 3 Fabric or MFC front panels

G1: Band A MFC		G2: Band B MFC			G3: Band A Veneer			G3: Band B Veneer		
	CODE	DESCRIPTION	WIDTH	DEPTH	HEIGHT	G1 (£)	G2 (£)	G3 (£)	G4 (£)	
	RMP202	MFC/veneer front panel for reception unit carcass	200	18	972	51	63	111	132	
	RMP402		400	18	972	76	87	180	214	
	RMP602		600	18	972	96	130	249	297	
	RMP802		800	18	972	124	166	318	387	



G1: Step/Step Melange		G2: Velito / Synergy							
	CODE	DESCRIPTION	WIDTH	DEPTH	HEIGHT	G1 (£)	G2 (£)		
	RMP200	W200mm fabric front panel for reception unit carcass	200	18	972	102	126		
	RMP201		200	31	972	127	175		
	RMP400	W400mm fabric front panel for reception unit carcass	400	18	972	144	178		
	RMP401		400	31	972	181	236		
	RMP600	W600mm fabric front panel for reception unit carcass	600	18	972	224	296		
	RMP601		600	31	972	305	394		
	RMP800	W800mm fabric front panel for reception unit carcass	800	18	972	351	475		
	RMP801		800	31	972	375	487		

Step 1 L-shape carcass, L/H or R/H





G1: Band A MFC		G2: Band B MFC			G3: Band A Veneer			G3: Band B Veneer		
	CODE	DESCRIPTION	WIDTH	DEPTH	HEIGHT	G1 (£)	G2 (£)	G3 (£)	G4 (£)	
	RMS200	Reception unit L-shaped L/H carcass (without desks), MFC or veneer top, inner and plinth <i>Requires side and front panels</i>	2035	1040	1100	1,567	1,770	3,347	3,975	
	RMS300		3035	1040	1100	2,088	2,360	4,292	5,127	
	RMS340		3435	1040	1100	2,278	2,577	4,665	5,631	
	RMS201	Reception unit L-shaped R/H carcass (without desks), MFC or veneer top, inner and plinth <i>Requires side and front panels</i>	2035	1040	1100	1,544	1,741	3,278	3,899	
	RMS301		3035	1040	1100	2,092	2,365	4,292	5,127	
	RMS341		3435	1040	1100	2,262	2,560	4,665	5,624	





Step 2 L-shape fabric side panels

(both required)

G1: Step/Step Melange		G2: Velito / Synergy / Cyber					
	CODE	DESCRIPTION	WIDTH	DEPTH	HEIGHT	G1 (£)	G2 (£)
	RMK201	Fabric side panel for L-shaped reception unit carcass <i>Required</i>	182	435	972	385	492
	RMK200	Fabric side panel for reception unit carcass <i>Required</i>	1040	200	972	857	1,091

Step 3 Fabric or MFC front panels

G1: Band A MFC		G2: Band B MFC			G3: Band A Veneer			G3: Band B Veneer		
	CODE	DESCRIPTION	WIDTH	DEPTH	HEIGHT	G1 (£)	G2 (£)	G3 (£)	G4 (£)	
	RMP202	MFC/veneer front panel for reception unit carcass	200	18	972	51	63	111	132	
	RMP402		400	18	972	76	87	180	214	
	RMP602		600	18	972	96	130	249	297	
	RMP802		800	18	972	124	166	318	387	

G1: Step/Step Melange		G2: Velito / Synergy					
	CODE	DESCRIPTION	WIDTH	DEPTH	HEIGHT	G1 (£)	G2 (£)
	RMP200	W200mm fabric front panel for reception unit carcass	200	18	972	102	126
	RMP201		200	31	972	127	175
	RMP400	W400mm fabric front panel for reception unit carcass	400	18	972	144	178
	RMP401		400	31	972	181	236
	RMP600	W600mm fabric front panel for reception unit carcass	600	18	972	224	296
	RMP601		600	31	972	305	394
	RMP800	W800mm fabric front panel for reception unit carcass	800	18	972	351	475
	RMP801		800	31	972	375	487

Nova

Reception desk panels

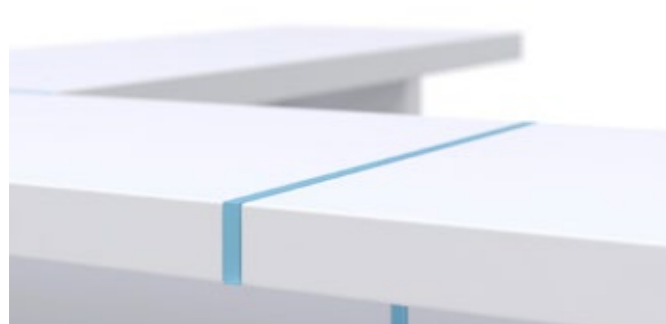

Straight, clean, stylish lines mark this simple but effective range of reception fronts to complement the Nova bench desking range.

Contrasting Plexiglas® lines define and break up the panels giving a pleasing effect to large or small runs of panels. Simply choose your Nova desks from the desking section and add the panels from here to create your complete reception unit.

Range

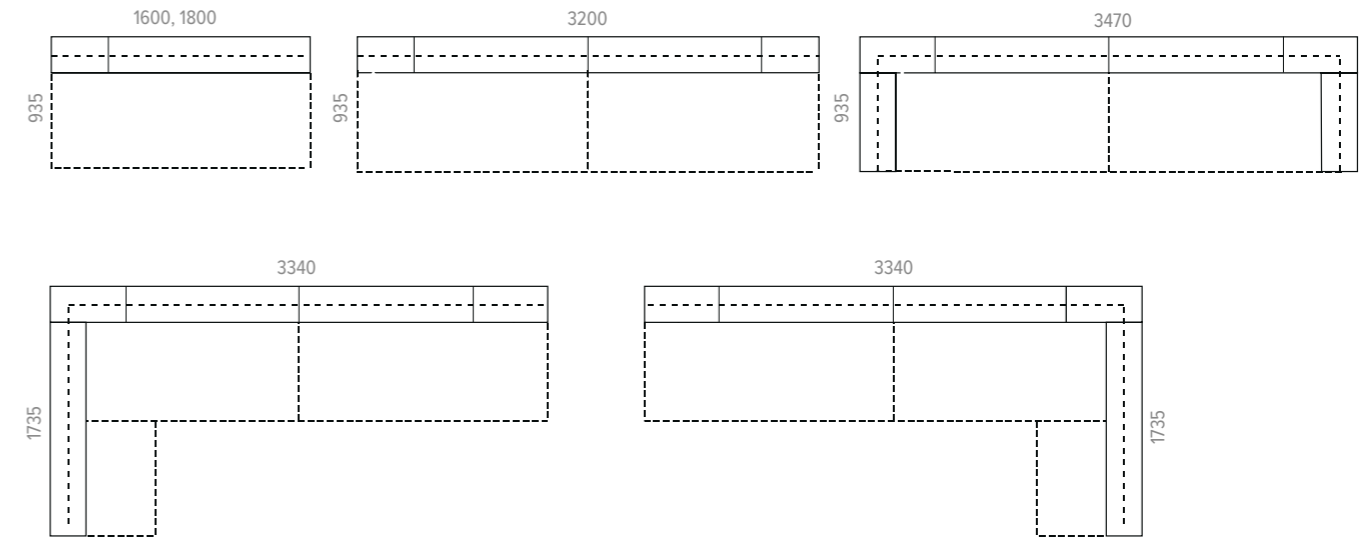

Technical details

Modesty panels

- 18mm MFC with 0.5mm ABS edging
- 6mm Plexiglas® inserts
- Modesty panels are fixed to the desktop and legs with metal brackets

Top of modesty panels

- 25mm MFC with 2mm ABS edging

NOVA DESKS (ORDERED SEPARATELY)

Desktop

- 25mm MFC with 2mm ABS edging
- 10mm gap between the legs and the desktop.

Metal beam

- Metal tube - 40 x 20 mm
- With welded metal plates for leg fixing
- Powder coated metal, colour matches the legs

Legs

- Welded metal tube - 40 x 40 mm
- Powder coated metal
- Plastic feet with height levelling (+10mm)
- Desk height – 740mm

Materials

Band A MFC

- Whitened Oak (D1)
- Amber Oak (D2)
- White (M1)
- Dark Grey (N1)
- Pearl Grey (N3)

Band B MFC

- Sand Ash (D3)
- Dark Walnut (D4)
- Grey Wood (D5)
- Cubanit Grey (N2)
- Black (J4)







Plexiglas®

- White (R01)
- Orange (R03)
- Ice Blue (R06)
- Light Green (R07)
- Cherry (R08)
- Brown (R09)





Metal

- Anthracite (T1)
- Black (A)
- Grey (M)
- White (E)

G1: Band A MFC Modesty Panel & Top
 G2: Band A MFC Modesty Panel + Band B MFC Top
 G3: Band B MFC Modesty Panel + Band A MFC Top
 G4: Band B MFC Modesty Panel & Top

	CODE	DESCRIPTION	WIDTH	DEPTH	HEIGHT	G1 (£)	G2 (£)	G3 (£)	G4 (£)
	RNS100	Full height modesty panel, front only	1600	935	1125	523	586	606	629
	RNS101	L/H full height modesty panel, front and one return side	1800	935	1125	638	675	745	782
	RNS203	L/H full height modesty panel, front and one return side	3200	935	1125	1,221	1,359	1,439	1,556
	RNS201	L/H full height modesty panel, front and one return side	3340	1735	1125	1,882	1,983	2,153	2,249
	RNS202	R/H full height modesty panel, front and one return side	3340	1735	1125	1,871	1,989	2,153	2,254
	RNS200	Full height modesty panel, front and both return sides	3470	935	1125	2,098	2,203	2,383	2,485

Desks ordered separately - see opposite

	CODE	DESCRIPTION	WIDTH	DEPTH	HEIGHT	G1 (£)	G2 (£)
	DNS328-U	2 desk inline bench with scoop backs for cable management For use with RNS203, RNS201, RNS202, RNS200	3200	800	740	922	1,000
	DNA165-U	Desk with scoop back cable management	1600	800	740	489	529
	DNA185-U	Desk with scoop back cable management	1800	800	740	533	591
	DNC080-U	Return unit	800	600	740	230	247



Cosy

Reception desk



A first impression is a lasting impression and Cosy's contemporary curved lines give a confident, professional impression your visitors are sure to remember.

The clean, modern look with no sharp corners on the front make your office look welcoming yet sophisticated.

Range

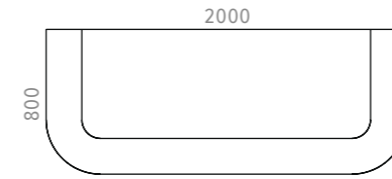

Desktop: 1960 x 780 x H740 mm

Technical details

1. Desktop

- 25mm MFC with 2mm ABS edging

2. Top of upper unit

- 25mm MFC with 2mm ABS edging

3. Modesty panel

- 19mm chipboard pressed with CPL with 1mm ABS edging

4. Curved modesty panel

- 19mm three layer flexible plywood pressed with CPL with 1mm ABS / thin edging

5. Modesty panel and desktop supports

- 25mm MFC with 2mm ABS edging

6. Upper unit supports

- 25mm MFC with 2mm ABS edging

7. Plinth base

- Exterior part (front and side facades) pressed with polished aluminium colour HPL

8. Grommets

- Ø80mm grey plastic cable ports

Materials

CPL / MFC

White (H70M1)

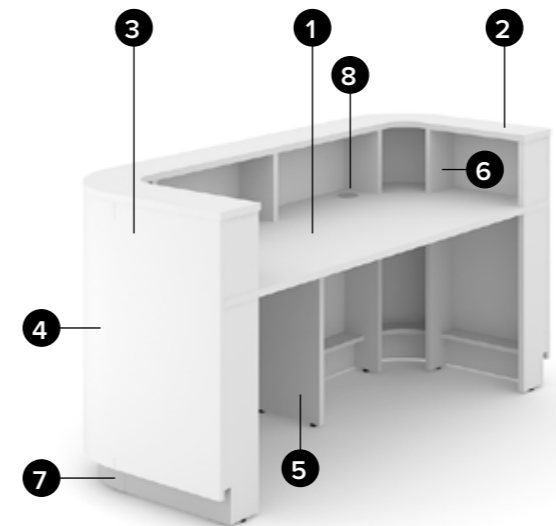

	CODE	DESCRIPTION	WIDTH	DEPTH	HEIGHT	RSP (€)
	RCS200	Reception unit with desk and 2 round cutouts for cable management	2000	800	1025	3,904

Tera

Reception desk system



Tera modular reception furniture system offers various combinations of modules in different forms and sizes and is ideal for reception areas of various offices.

Individual segments are easily combined together to create a sleek unified form. The thin panel breaks help to maintain a lightweight feel.

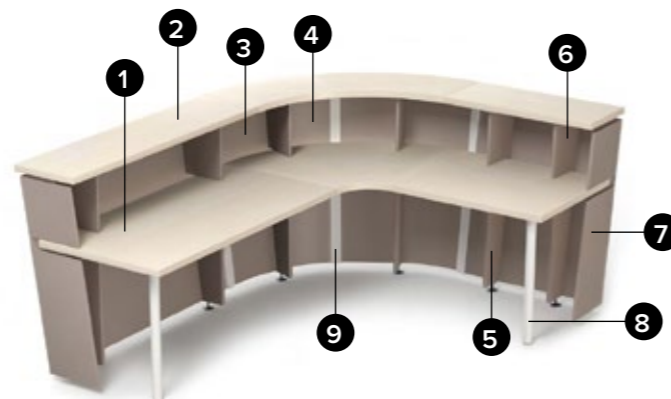

Range

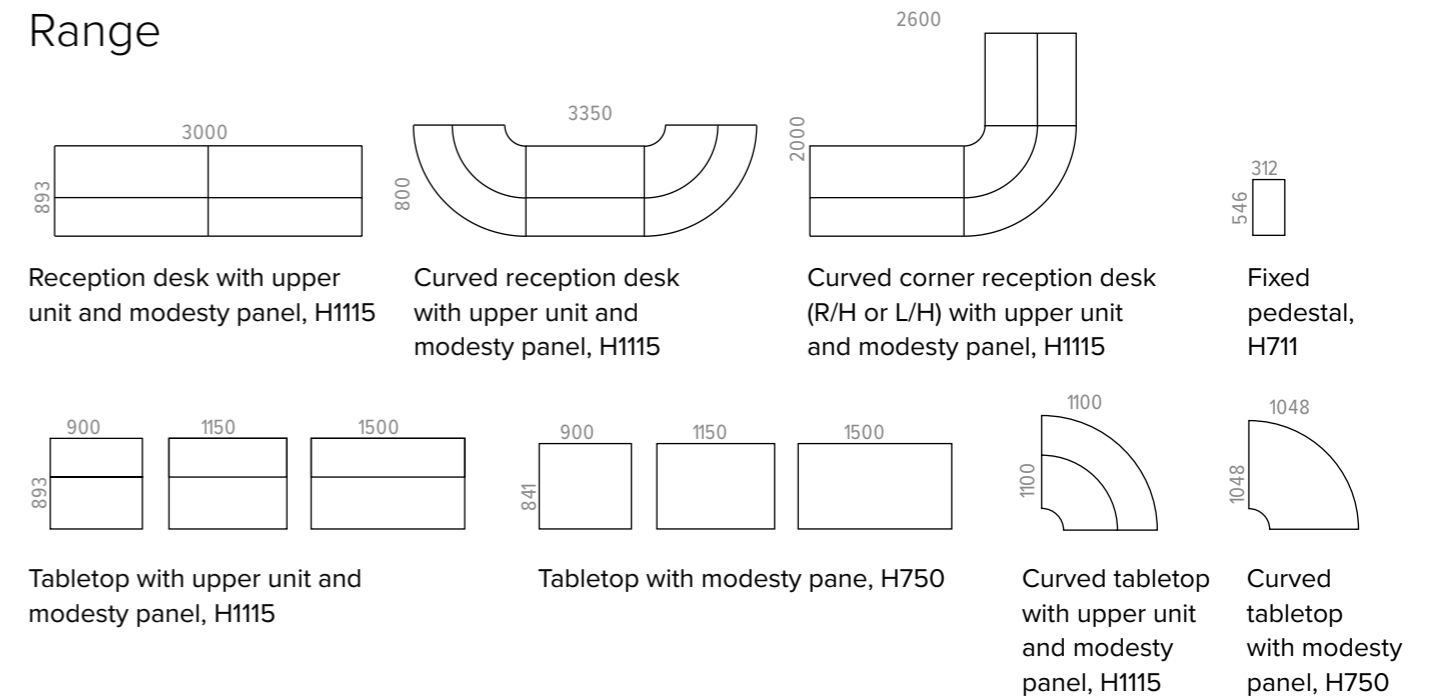

Technical details

1. Desktop

- 36mm MFC with 2mm ABS edging

2. Top of upper unit

- 36mm MFC with 2mm ABS edging

3. Modesty panel

- 16mm MFC with 0.5mm ABS edging
- 16 mm MDP pressed HPL with 0.5mm ABS edging

4. Curved modesty panel

- 16mm MDP pressed HPL with 0.5mm ABS edging

5. Tabletop supports

- 25mm MFC with 2mm and 0.5mm ABS edging
- 25mm MDP pressed HPL with 0.5mm ABS edging

6. Upper unit supports

- 16mm MFC with 1mm and 0.5mm ABS edging
- 16mm MDP pressed HPL with 0.5mm ABS edging

7. Tabletop & upper unit side panels

- 16mm MFC with 1mm and 0.5mm ABS edging
- 16mm MDP pressed HPL with 0.5mm ABS edging

8. Metal legs

- 50mm powder coated metal round tube
- Metal plate attached in the end (to attach tube to the desktop)
- Plastic feet with height levelling (+10mm)

9. Metal strips

- 1.5mm perforated powder coated metal sheet

PEDESTALS*

Carcass

- Made of 16mm MFC with 0.5mm ABS edging

Drawers

- Front made of 16mm MFC
- Drawer box made of 16mm MFC
- Bottom made of 4mm fiberboard painted white
- 0.5mm ABS edging
- Drawers single extensions L500mm
- Drawer for files full extensions L450mm, suitable for A4 and foolscap files
- 20kg max. load
- Central locking (without anti-tilt)
- Black plastic height levelling feet, H52mm

Materials

Band A MFC

- Whitened Oak (D1)
- Amber Oak (D2)
- White (M1)
- Dark Grey (N1)
- Pearl Grey (N3)

Band B MFC

- Sand Ash (D3)
- Dark Walnut (D4)
- Grey Wood (D5)
- Cubanit Grey (N2)
- Black (J4)

Band A HPL

- Dark Grey (H57)
- White (H70)

Band B HPL





- Grey (H12)
- Cappuccino (H13)

Metal







- Anthracite (T1)
- White (E)





* Must be ordered when combining only straight segments (one or several depending on the combination length)



G1: Band A MFC Top & Sides
 G2: Band B MFC Top + Band A MFC Sides
 G3: Band A MFC Top + Band B MFC Sides
 G4: Band B MFC Top & Sides
 G5: Band A MFC Top + HPL Sides
 G6: Band B MFC Top + HPL Sides



	CODE	DESCRIPTION	WIDTH	DEPTH	HEIGHT	G1 (£)	G2 (£)	G3 (£)	G4 (£)	G5 (£)	G6 (£)
	RVS300	Reception unit with desks and fixed pedestals	3000	893	1115	3,559	3,804	4,274	4,512	5,298	6,013
	RVA091	Tabletop with upper unit and modesty panel (central unit)	900	893	1115	671	749	892	969	1,202	1,422
	RVA111		1150	893	1115	816	898	1,083	1,167	1,428	1,697
	RVA151		1500	893	1115	996	1,103	1,312	1,412	1,740	2,054
	RVA093	Tabletop with modesty panel (central unit)	900	841	750	463	505	601	642	797	941
	RVA113		1150	841	750	568	616	741	788	961	1,128
	RVA153		1500	841	750	676	753	886	957	1,152	1,360
	RVA092	Tabletop with upper unit and modesty panel (R/H or L/H end unit)	900	893	1115	709	780	929	1,001	1,239	1,459
	RVA112		1150	893	1115	847	930	1,115	1,199	1,460	1,727
	RVA152		1500	893	1115	1,027	1,133	1,341	1,449	1,772	2,087
	RVA094	Tabletop with modesty panel (R/H or L/H end unit)	900	841	750	494	537	638	680	827	971
	RVA114		1150	841	750	606	654	772	820	992	1,158
	RVA154		1500	841	750	713	785	916	986	1,189	1,392

G1: Band A MFC Top + Band A HPL Sides
 G2: Band B MFC Top + Band A HPL Sides
 G3: Band A MFC Top + Band B HPL Sides
 G4: Band B MFC Top + Band B HPL Sides

	CODE	DESCRIPTION	WIDTH	DEPTH	HEIGHT	G1 (£)	G2 (£)	G3 (£)	G4 (£)
	RVS335	Curved reception unit with desk	3350	1100	1115	8,486	9,421	9,838	10,778
	RVS260	Curved corner reception unit with desks (L/H or R/H)	2600	2000	1115	5,768	6,638	7,537	8,407
	RVB901	90° tabletop with upper unit and modesty panel (central unit)	1100	-	1115	3,576	3,818	3,909	4,152
	RVB903	90° tabletop with modesty panel (central unit)	1048	-	750	3,205	3,371	3,395	3,555
	RVB902	90° tabletop with upper unit and modesty panel (R/H or L/H end unit)	1100	-	1115	3,606	3,851	3,940	4,189
	RVB904	90° tabletop with modesty panel (R/H or L/H end unit)	1048	-	750	3,241	3,402	3,432	3,593

		G1: Band A MFC	G2: Band B MFC			G3: Band A HPL		
	CODE	DESCRIPTION	WIDTH	DEPTH	HEIGHT	G1 (£)	G2 (£)	G3 (£)
	RVT100	R/H lower side panel	396	16	650	97	108	179
	RVT101	L/H lower side panel	396	16	650	97	108	179
	RVT200	R/H upper side panel	347	16	305	69	69	111
	RVT201	L/H upper side panel	347	16	305	69	69	111

		G1: Band A MFC	G2: Band B MFC				
	CODE	DESCRIPTION	WIDTH	DEPTH	HEIGHT	G1 (£)	G2 (£)
	RVP535	Fixed pedestal (3 foil wrapped drawers incl. full extension file drawer suitable for A4 and foolscap filing, central locking)	312	546	711	540	569
	RVP542	Fixed pedestal (4 foil wrapped drawers, central locking)	312	546	711	555	596

	CODE	DESCRIPTION	WIDTH	DEPTH	HEIGHT	RSP (£)
	RVZ001	Metal strip for connection of 2 high modesty panels	-	-	-	65
	RVZ002	Metal strip for connection of 2 low modesty panels or 1 high and 1 low modesty panel	-	-	-	67
	ZZT100	Leg for supporting combinations	-	-	710	45



Ice

Reception desk

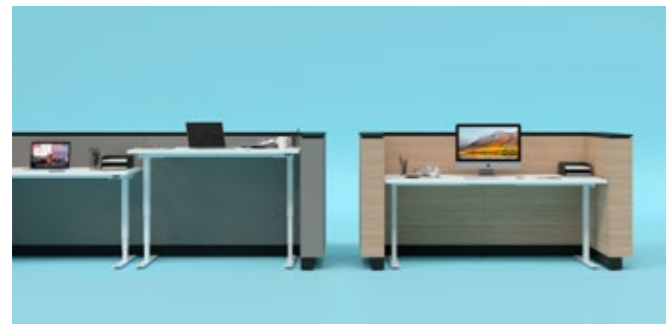
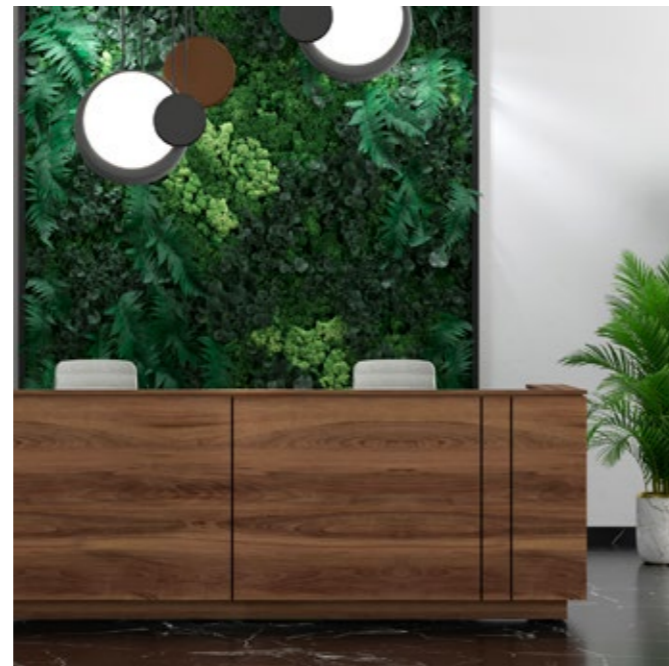

Minimalistic design with subtle combinations

Depending on your vision for the interior, choose between a cozy melamine, or a luxurious veneer finish. Various front and top combinations are also available.

Using the same finish on the top, base and front will create a solid and minimalistic reception unit, which will be as clean and smooth as ice!

Alternatively, introducing a different-coloured top or decorative inserts will allow you to subtly reveal the elegance of this reception unit.

The Ice reception unit fits either one or two workstations, a perfect match for sit/stand or fixed-height desks.

Range

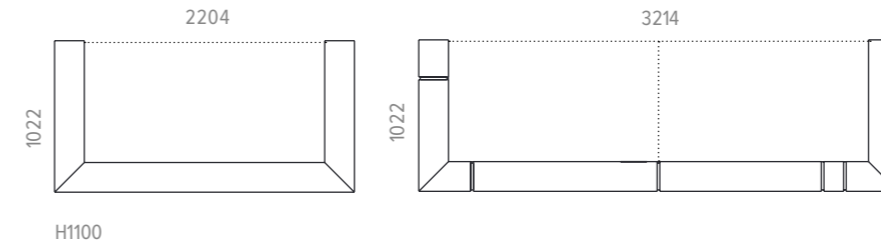

Technical details

Back/inside panels

- 17mm chipboard covered with veneer, with 1.5mm edging
- 18mm MFC with 1mm ABS edging

Top

- 17mm chipboard covered with veneer, with 1.5mm edging
- 18mm MFC with 2mm ABS edging

Plinth

- Exterior part (front and side facades) MFC or veneer
- 18mm MFC with 1mm ABS edging
- 17mm chipboard covered with veneer, with 1.5mm edging

Carcass (inserts)*

- 16mm MFC with 1mm ABS edging
- 18mm MDF
- Black (J4) or white (M1) MFC

Facades

- 17mm chipboard covered with veneer, with 1.5mm edging
- 16mm MFC with 2mm ABS edging

Materials

Band A MFC

- Whitened Oak (D1)
- Amber Oak (D2)
- White (M1)
- Pearl Grey (N3)
- Dark Grey (N1)

Band B MFC

- Sand Ash (D3)
- Dark Walnut (D4)
- Grey Wood (D5)
- Cubanit Grey (N2)
- Black (J4)

Band A Veneer

- Oak (AA)
- Ash stained Black (N61)
- Walnut (RR)
- Ash (V1)

Band B Veneer

- Ash stained Dark Brown (N62)
- Walnut stained Grey (N63)

Insert MFC

- White (M1)
- Black (J4)

G1: Band A MFC Panels & Top/Plinth

G2: Band A MFC Panels + Band B MFC Top/Plinth

G3: Band B MFC Panels + Band A MFC Top/Plinth

G4: Band B MFC Panels & Top/Plinth

G5: Band A Veneer Panels & Top/Plinth

G6: Band B Veneer Panels & Top/Plinth

	CODE	DESCRIPTION	WIDTH	DEPTH	HEIGHT	G1 (£)	G2 (£)	G3 (£)	G4 (£)	G5 (£)	G6 (£)
	RNS221	Reception unit with inserts for 1 x W1800mm desk	2204	1022	1100	3,634	3,749	4,052	4,226	5,977	6,694
	RNS321	Reception unit with inserts for 2 x W1400mm desks	3214	1022	1100	4,409	4,561	4,936	5,088	7,250	8,148
	RNS222	Reception unit for 1 x W1800mm desk	2204	1022	1100	3,570	3,690	3,976	4,091	5,890	6,607
	RNS322	Reception unit for 2 x W1400mm desks	3214	1022	1100	4,388	4,541	4,898	5,056	7,169	8,047

* RNS221 and RNS321 only

Executive

Executive desks

Executive storage



Move & Lead executive sit/stand desk

Arqus NEW

Executive furniture



Arqus is a collection of executive furniture with a modern luxury feel consisting of desks, meeting tables, wardrobes and cabinets. Arqus executive furniture has a modern aesthetic that appeals for its simplicity and elegance.

The sleek, subtly rounded shapes and lines of Arqus are reflected in every part of the furniture – in the shape of the legs and the chamfers of the tabletop or cabinets. The collection uses the highest quality materials – natural veneer and leather, symbolising luxury and refinement.

Choose a desk with a regular rectangular desktop or an asymmetric one, where the desktop tapers to the left or right. A fixed pedestal to the left or right of the desk with a height-adjustable shelf and drawers frees up desk space.

Thoughtful power solutions will allow you to have a comfortable place to work or hold meetings. Executive desks have built-in power socket blocks and meeting tables come with grommets and boxes for the power socket blocks of your choice.

Range

Rectangular desks*

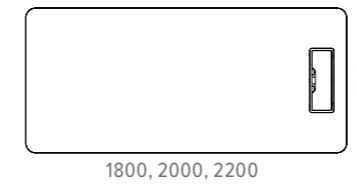

Trapezoid desks*

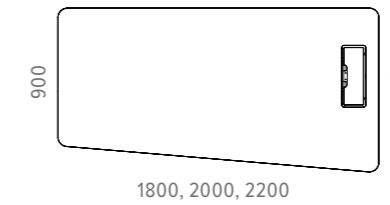

Modesty panel

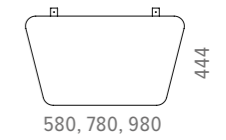

Rectangular desks with pedestal*

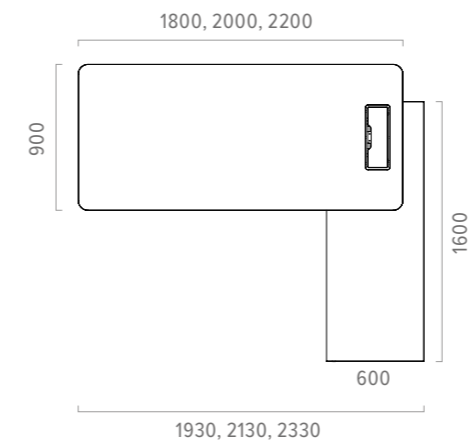

Trapezoid desks with pedestal*

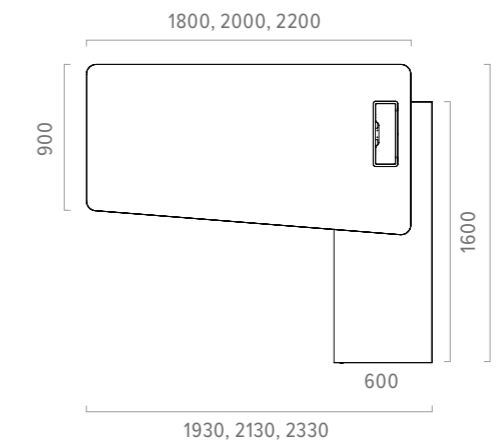

Modesty panel

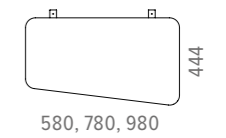

Cabinet

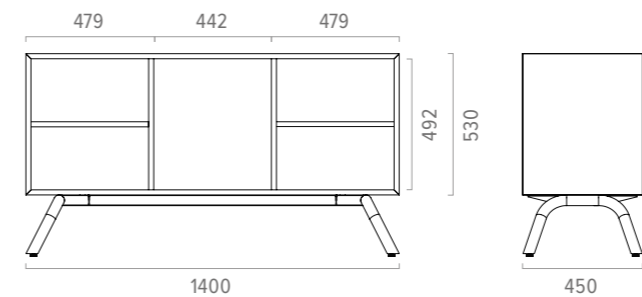

Leather mat/pad

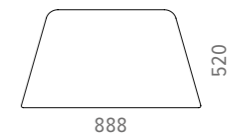

Wardrobe

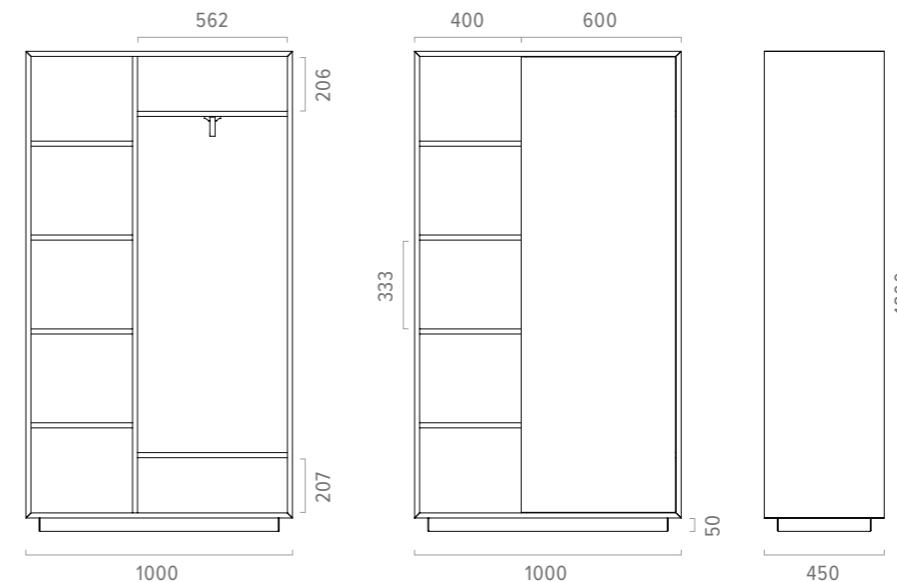

* Diagram shows R/H desk. L/H version is mirrored.

Range

Rectangular, 6 seats

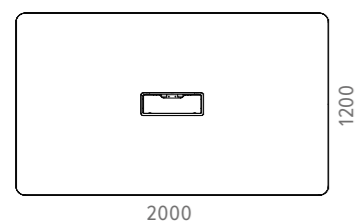

Boat shaped, 6 seats

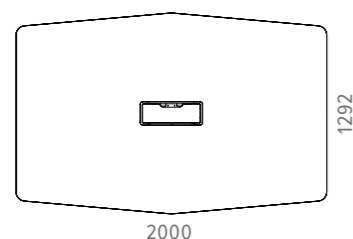

Rectangular, 8/10 seats

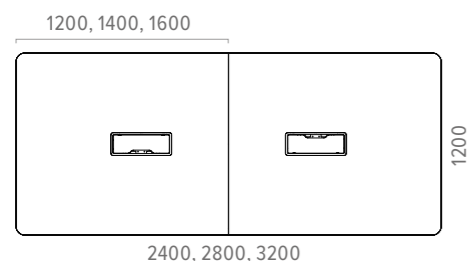

Boat shaped, 8/10 seats

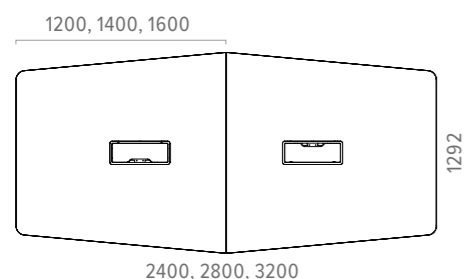

Rectangular, 12 seats

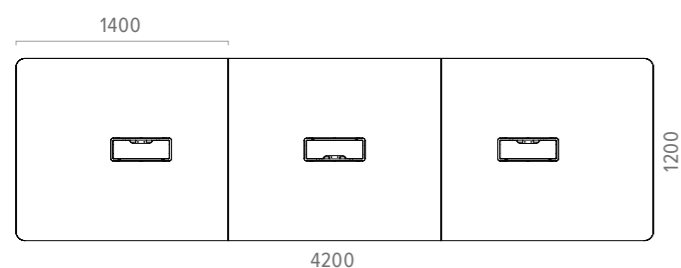

Boat shaped, 12 seats

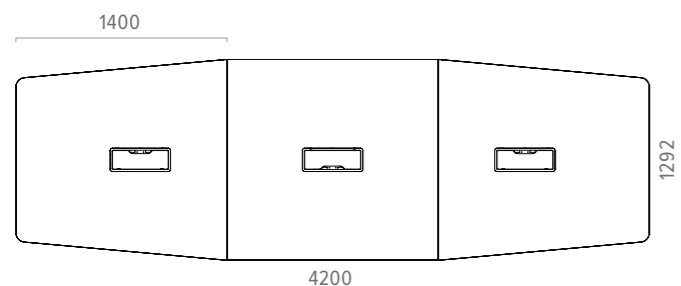

Technical details

DESKS

Desktop

- 30mm chipboard covered in veneer with solid wood profile edging
- Grain direction runs the length of the desktop
- Rectangular or trapezoid shape

Metal frame

- Round powder coated metal structure made of Ø40mm tube
- Cut-outs in one of the two tubes for modesty panel attachment
- Connects between the legs or between the leg and support (desks with a pedestal)

Legs

- Bent and welded round powder coated metal structure made of Ø40mm tube
- Connects with frame and desktop
- Plastic feet with height levelling (+10mm)

Support (for desks with a pedestal)

- Bent and welded round powder coated metal structure made of Ø40mm tube
- Connects with frame, desktop and pedestal

Rectangular grommet with frame

- 13mm veneer cover, grain direction matched with desktop
- Grommet: 370x120mm
- Hinges with a soft-closing function
- Steel powder coated metal frame – 13mm width on top, flush with the desktop surface
- Metal frame: 400x150 mm

Box with power socket block

- Powder coated metal box: 385x130x H120 mm
- Integrated power block with 3 x AC power sockets 100-240V

FIXED PEDESTALS

Carcass

- 18mm MDF covered in veneer with four drawers and two closed storage spaces

Drawers

- Facades are made of 18mm MDF covered in veneer with one solid wood profile edging
- Drawer box is made of 12mm chipboard covered in veneer
- Full extension handleless drawers with hidden runners
- Lockable top corner drawer with bottom covered in leather
- Load capacity: 20kg

Doors

- 18mm chipboard in veneer, push-to open-mechanism
- Enclosed space behind the side doors for cable management (not designed to use on a daily basis)
- One adjustable shelf behind the centre doors (vertically by 192mm)

Base

- Welded powder coated metal rectangular structure of 50x20mm tubes
- Plastic height levelling feet (+10mm)

DESK ACCESSORIES

Modesty panel

- MDF board upholstered with genuine leather
- Connects to desk frame with 3mm powder coated metal holders

File railing

- Set for one bottom drawer
- Suitable for EU / UK / US file standards

TABLES

Tabletop

- 30mm chipboard covered in veneer with solid wood profile edging
- Grain direction runs the length of the tabletop
- Rectangular and boat shaped

Metal legs

- Bent and welded round powder coated metal tube structure made of Ø40mm tube
- Connects with frame and tabletop
- Plastic feet with height levelling (+10mm)

Central leg

- Bent and welded round powder coated metal tube structure, Ø40mm tube
- Connects with frame and tabletop
- Plastic height levelling feet (+10mm)

Metal frame

- Round powder coated metal tube structure, tube Ø40mm
- Connects between the legs

Rectangular grommet with frame

- See grommet with 'DESKS'

Box for power socket block

- Powder coated metal box dimensions – 385x130xH120 mm
- Fixing points for optional power blocks

CABINET + WARDROBE

Carcass

- 18mm chipboard covered in veneer

Shelves

- 18mm chipboard covered in veneer
- Load capacity: 25kg
- Pull-out coat hanger, load capacity: 3kg (Wardrobe only)

Doors

- 18mm chipboard covered in veneer, push-to open-mechanism

Cabinet Legs

- Bent and welded round powder coated metal structure made of Ø40mm tube
- Plastic feet with height levelling (+10mm)

Wardrobe Base

- Rectangular welded powder coated metal structure made of 50x20 mm tube
- Plastic height levelling feet (+10mm)

Materials

G1: Veneer

- Walnut (RR)
- Ash stained Black (N61)
- Ash (V1)
- Oak (AA)

G2: Veneer









- Ash stained Dark Brown (N62)
- Walnut stained Grey (N63)









Frame Metal









- Black (A)
- White (E)
- Grey (M)
- Dark Grey (T1)
- Deep Bronze (S1)





Leather Modesty Panel / Mat

- Cappuccino (D97)
- Dark Brown (D88)
- Black (D81)

	CODE	DESCRIPTION	WIDTH	DEPTH	HEIGHT	G1 (£)	G2 (£)
	BAK001	Single executive workstation with fixed R/H pedestal, box with built-in power socket block, modesty panel and leather table mat	2130	1830	760	6,994	7,785
	BAQ180	Executive desk. Rectangular desktop with grommet and box with built-in power socket block	1800	900	760	2,434	2,637
	BAQ200		2000	900	760	2,611	2,840
	BAQ220		2200	900	760	2,788	3,042
	BAQ190	Executive desk with fixed R/H pedestal. Rectangular desktop with grommet and box with built-in power socket block	1930	1830	760	5,986	6,703
	BAQ210		2130	1830	760	6,162	6,906
	BAQ230		2330	1830	760	6,339	7,109
	BAQ191	Executive desk with fixed L/H pedestal. Rectangular desktop with grommet and box with built-in power socket block	1930	1830	760	5,986	6,703
	BAQ211		2130	1830	760	6,162	6,906
	BAQ231		2330	1830	760	6,339	7,109
	BAQ181	Executive desk. Desktop (tapering to the left) with grommet and box with built-in power socket block	1800	1045	760	2,632	2,876
	BAQ201		2000	1062	760	2,855	3,131
	BAQ221		2200	1080	760	3,079	3,386
	BAQ182	Executive desk. Desktop (tapering to the right) with grommet and box with built-in power socket block	1800	1045	760	2,632	2,876
	BAQ202		2000	1062	760	2,855	3,131
	BAQ222		2200	1080	760	3,079	3,386
	BAQ192	Executive desk with fixed R/H pedestal. Desktop (tapering to the left) with grommet and box with built-in power socket block	1930	1830	760	6,183	6,942
	BAQ212		2130	1830	760	6,407	7,197
	BAQ232		2330	1830	760	6,630	7,452
	BAQ193	Executive desk with fixed L/H pedestal. Desktop (tapering to the right) with grommet and box with built-in power socket block	1930	1830	760	6,183	6,942
	BAQ213		2130	1830	760	6,407	7,197
	BAQ233		2330	1830	760	6,630	7,452

	CODE	DESCRIPTION	WIDTH	DEPTH	HEIGHT	RSP (£)
	BAZ580	Modesty panel for 1800mm length desk, symmetric	580	28	444	182
	BAZ780	Modesty panel for 2000mm length desk, symmetric	780	28	444	250
	BAZ980	Modesty panel for 2200mm length desk, symmetric	980	28	444	323
	BAZ581	Modesty panel for 1930mm length desk, asymmetric	580	28	444	203
	BAZ781	Modesty panel for 2130mm length desk, asymmetric	780	28	444	260
	BAZ981	Modesty panel for 2330mm length desk, asymmetric	980	28	444	338
	BAZ001	Leather table mat	888	520	8	328
	BAZ002	File railing set for one bottom drawer	423	50	10	99

	CODE	DESCRIPTION	WIDTH	DEPTH	HEIGHT	G1 (£)	G2 (£)
	DAQ140	Cabinet with 2 doors, 1 fixed shelf and 1 height-adjustable shelf inside; push to open system	1400	450	760	2,585	3,011
	DAQ100	Wardrobe (L/H) with metal pull-out hanging rail and shelves	1000	450	1800	3,932	4,680
	DAQ101	Wardrobe (R/H) with metal pull-out hanging rail and shelves	1000	450	1800	3,932	4,680
	CAQ200	Meeting table (6 seats) with grommet and box for power socket block; rectangular tabletop	2000	1200	760	2,247	2,481
	CAQ240	Meeting table (8 seats) with 2 grommets and boxes for power socket blocks; rectangular tabletop	2400	1200	760	2,938	3,240
	CAQ280		2800	1200	760	3,261	3,594
	CAQ320	Meeting table (10 seats) with 2 grommets and boxes for power socket blocks; rectangular tabletop	3200	1200	760	3,583	3,666
	CAQ420	Meeting table (12 seats) with 3 grommets and boxes for power socket blocks; rectangular tabletop	4200	1200	760	4,597	5,096
	CAQ201	Meeting table (6 seats) with grommet and box for power socket block; boat-shaped tabletop	2000	1292	760	2,403	2,658

	CODE	DESCRIPTION	WIDTH	DEPTH	HEIGHT	G1 (£)	G2 (£)
	CAQ241	Meeting table (8 seats) with 2 grommets and boxes for power socket blocks; boat-shaped tabletop	2400	1292	760	3,084	3,396
	CAQ281		2800	1292	760	3,438	3,802
	CAQ321	Meeting table (10 seats) with 2 grommets and boxes for power socket blocks; boat-shaped tabletop	3200	1292	760	3,781	4,186
	CAQ421	Meeting table (12 seats) with 3 grommets and boxes for power socket blocks; boat-shaped tabletop	4200	1292	760	4,784	5,408

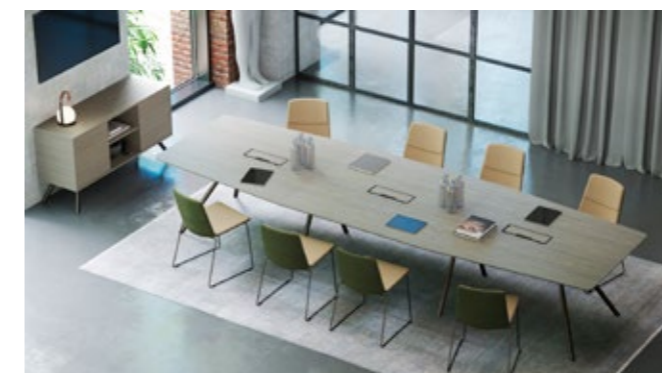

Nova Executive

Executive Desks / Storage

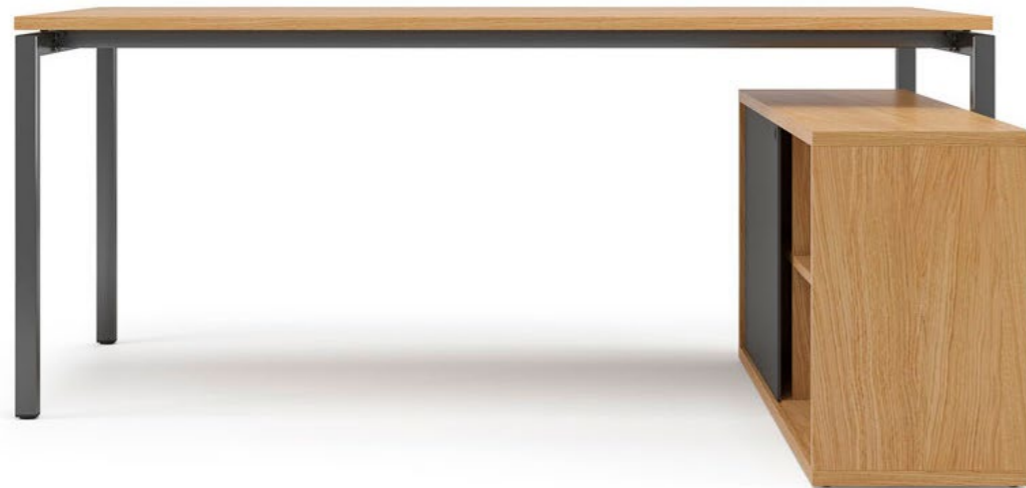

With moderate minimalism and smooth lines this collection is designed for modern executives who appreciate quality and functionality in the work environment.

Fast and easy to assemble, Nova Executive furniture takes the beautiful simplicity of the Nova desking and storage ranges and adds a touch of sophistication with 14 different desktop finishes and 4 metal leg/frame finishes.

[Find cable management](#)

Range

Desks



Cabinets

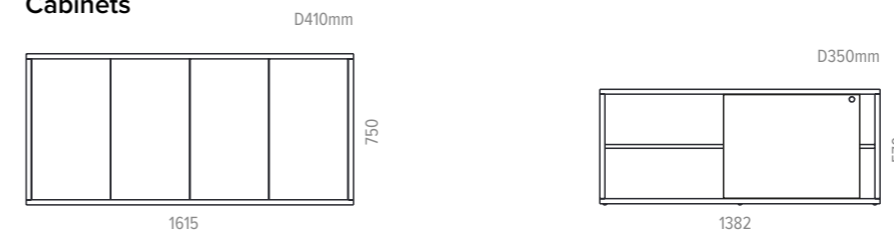

Technical details

DESK

Desktop

- 25mm MFC with 2mm ABS edging
- 25mm chipboard covered in wood veneer with 2mm edging
- 10mm gap between the legs and the desktop
- Plain desktop or with a cut-out for grommet and wire management

Legs

- Welded metal tube - 40x40 mm;
- Powder coated metal
- Plastic feet with height levelling (+10mm)
- Leg types – U or O

Metal beam

- Powder coated metal tube - 40x20 mm, matches leg colour
- With welded metal plates for leg fixing

CABINET + BOOKCASE

Carcass

- 25mm MFC with 2mm ABS edging
- 25mm chipboard covered in wood veneer with 3mm edging

Back

- 16mm MFC
- 16mm chipboard covered in wood veneer

Shelves

- 18mm MFC with 1mm ABS edging
- 18mm chipboard covered in wood veneer with 1.5mm edging
- Adjustable shelves
- Shelves load capacity – 25kg

Doors

- 18mm MFC with 1mm ABS edging
- 18mm wood veneer chipboard with 1.5 mm edging

Fittings

- Cams with connecting bolts
- Doors without handles with 'push to open' hinges
- Black plastic feet, H5mm

Sliding doors with lock

- Made from 6mm Plexiglas
- 100% recyclable matt and long-lasting surface (resistance to scratching and fingerprints)

Materials

G1: Band A MFC

- Whitened Oak (D1)
- Amber Oak (D2)
- White (M1)
- White with Amber Oak edge (M1D2)
- Pearl Grey (N3)
- Dark Grey (N1)

G2: Band B MFC

- Sand Ash (D3)
- Dark Walnut (D4)
- Grey Wood (D5)
- Cubanit Grey (N2)
- Black (J4)

Band A Veneer

- Oak (AA)
- Walnut (RR)
- Ash (V1)
- Ash stained Black (N61)

Band B Veneer







- Ash stained Dark Brown (N62)
- Walnut stained Grey (N63)

Frame Metal

- Black (A)
- White (E)
- Grey (M)
- Dark Grey (T1)

Plexiglas® Doors

- White (R01)
- Orange (R03)
- Light Blue (R06)
- Light Green (R07)
- Cherry (R08)
- Brown (R09)

G1: Band A MFC Top		G2: Band B MFC Top		G3: Band A Veneer Top			G4: Band B Veneer Top			
	CODE	DESCRIPTION	WIDTH	DEPTH	HEIGHT	G1 (£)	G2 (£)	G3 (£)	G4 (£)	
	BNA180-U	Desk	1800	1000	740	574	614	1,031	1,137	
	BNA200-U		2000	1000	740	594	640	1,092	1,232	
	BNA181-U	Desk with a cut-out for wire management on L/H side. ZNZ010 must be ordered	1800	1000	740	574	614	1,031	1,137	
	BNA201-U		2000	1000	740	594	640	1,092	1,232	
	BNA182-U	Desk with a cut-out for wire management on R/H side. ZNZ010 must be ordered	1800	1000	740	574	614	1,031	1,137	
	BNA202-U		2000	1000	740	594	640	1,092	1,232	
	BNA180-O	Desk	1800	1000	740	624	666	1,076	1,182	
	BNA200-O		2000	1000	740	646	692	1,137	1,277	
	BNA181-O	Desk with a cut-out for wire management on L/H side. ZNZ010 must be ordered	1800	1000	740	624	666	1,076	1,182	
	BNA201-O		2000	1000	740	646	692	1,137	1,277	
	BNA182-O	Desk with a cut-out for wire management on R/H side. ZNZ010 must be ordered	1800	1000	740	624	666	1,076	1,182	
	BNA202-O		2000	1000	740	646	692	1,137	1,277	

G1: Band A MFC Doors + Carcass G2: Band B MFC Doors + Band A MFC Carcass		G3: Band A MFC Doors + Band B Carcass G4: Band B MFC Doors + Carcass									
	CODE	DESCRIPTION	WIDTH	DEPTH	HEIGHT	G1 (£)	G2 (£)	G3 (£)	G4 (£)	G5 (£)	G6 (£)
	BQL201/P1	Executive cabinet with shelves and push opening system (without lock)	1615	410	750	891	902	997	1,008		
G1: M1 / N1 / N3 MFC Doors + Band A Veneer Carcass G2: N2 / J4 MFC Doors + Band A Veneer Carcass G3: Band A Veneer Doors & Carcass		G4: M1 / N1 / N3 MFC Doors + Band B Veneer Carcass G5: N2 / J4 MFC Doors + Band B Veneer Carcass G6: Band A Veneer Doors & Carcass									
	CODE	DESCRIPTION	WIDTH	DEPTH	HEIGHT	G1 (£)	G2 (£)	G3 (£)	G4 (£)	G5 (£)	G6 (£)
	BQL201/P2	Executive cabinet with shelves and push opening system (without lock)	1615	410	750	2,588	2,599	3,013	2,935	2,946	3,495
G1: Band A MFC Carcass + White Plexiglas Doors G2: Band B MFC Carcass + White Plexiglas Doors		G3: Band A MFC Carcass + Coloured Plexiglas Doors G4: Band B MFC Carcass + Coloured Plexiglas Doors									
	CODE	DESCRIPTION	WIDTH	DEPTH	HEIGHT	G1 (£)	G2 (£)	G3 (£)	G4 (£)	G5 (£)	G6 (£)
	DQF141/P1	Bookcase with shelves and sliding plexiglas door with lock	1382	350	570	717	790	941	1,008		
G1: Band A Veneer Carcass + White Plexiglas Doors G2: Band B Veneer Carcass + White Plexiglas Doors		G3: Band A Veneer Carcass + Coloured Plexiglas Doors G4: Band B Veneer Carcass + Coloured Plexiglas Doors									
	CODE	DESCRIPTION	WIDTH	DEPTH	HEIGHT	G1 (£)	G2 (£)	G3 (£)	G4 (£)	G5 (£)	G6 (£)
	DQF141/P2	Bookcase with shelves and sliding plexiglas door with lock	1382	350	570	924	1,126	1,148	1,344		

Move & Lead

Executive Desks / Storage



Move & Lead is a minimalist, elegant and functional executive office furniture system for a modern leader. It helps to stay on the move and be active even at a work desk. Keep moving, stay healthy and productive.

The Move & Lead executive office furniture system combines the best in ergonomics and cutting-edge technology and is designed for active leaders. Height can be adjusted between 784 mm and 1,378 mm so the desk can be easily adapted to personal needs.

A distinct feature of Move & Lead executive furniture is its mature and minimalist design. Clean, elegant lines, smooth transitions and subtle combinations of materials are guaranteed to make a strong visual impact in any office. HPL Fenix finish, natural oak, ash or walnut veneer and polished stainless steel surfaces form a harmonious whole and create a sense of subtle luxury.

[See cable management](#)

Range

Executive desks

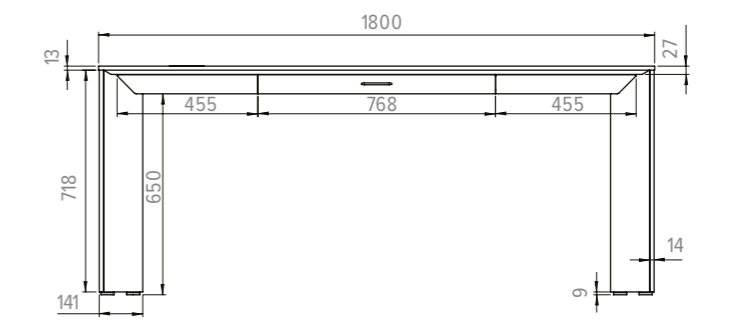
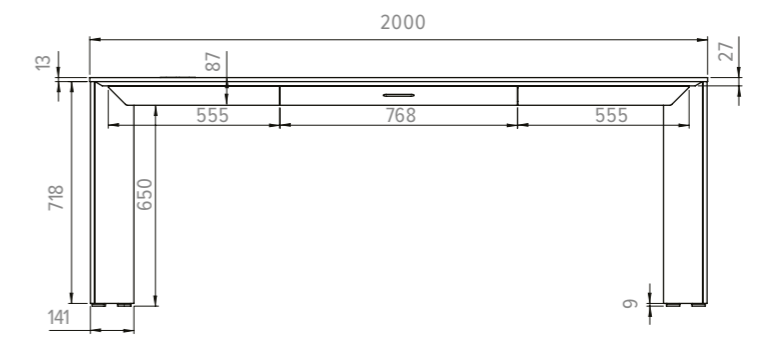
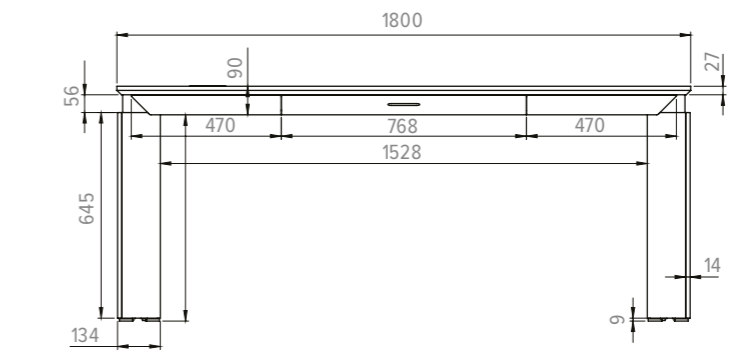
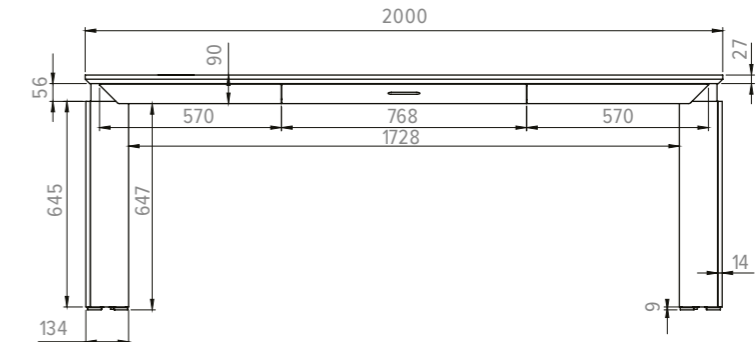
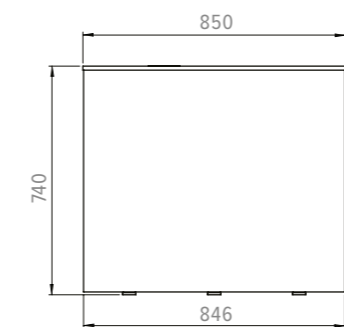
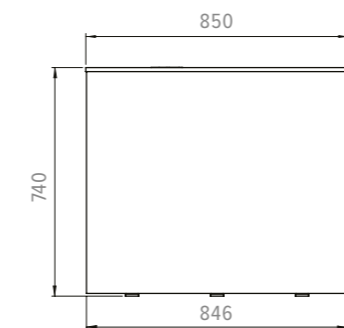
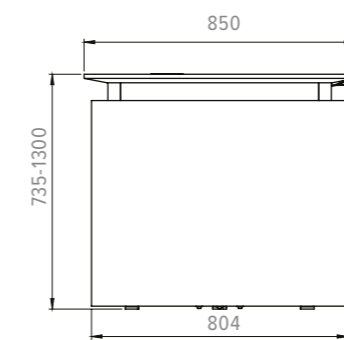
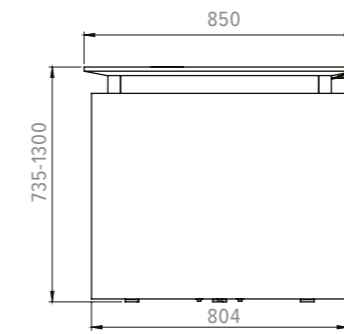

Range

Executive cabinets

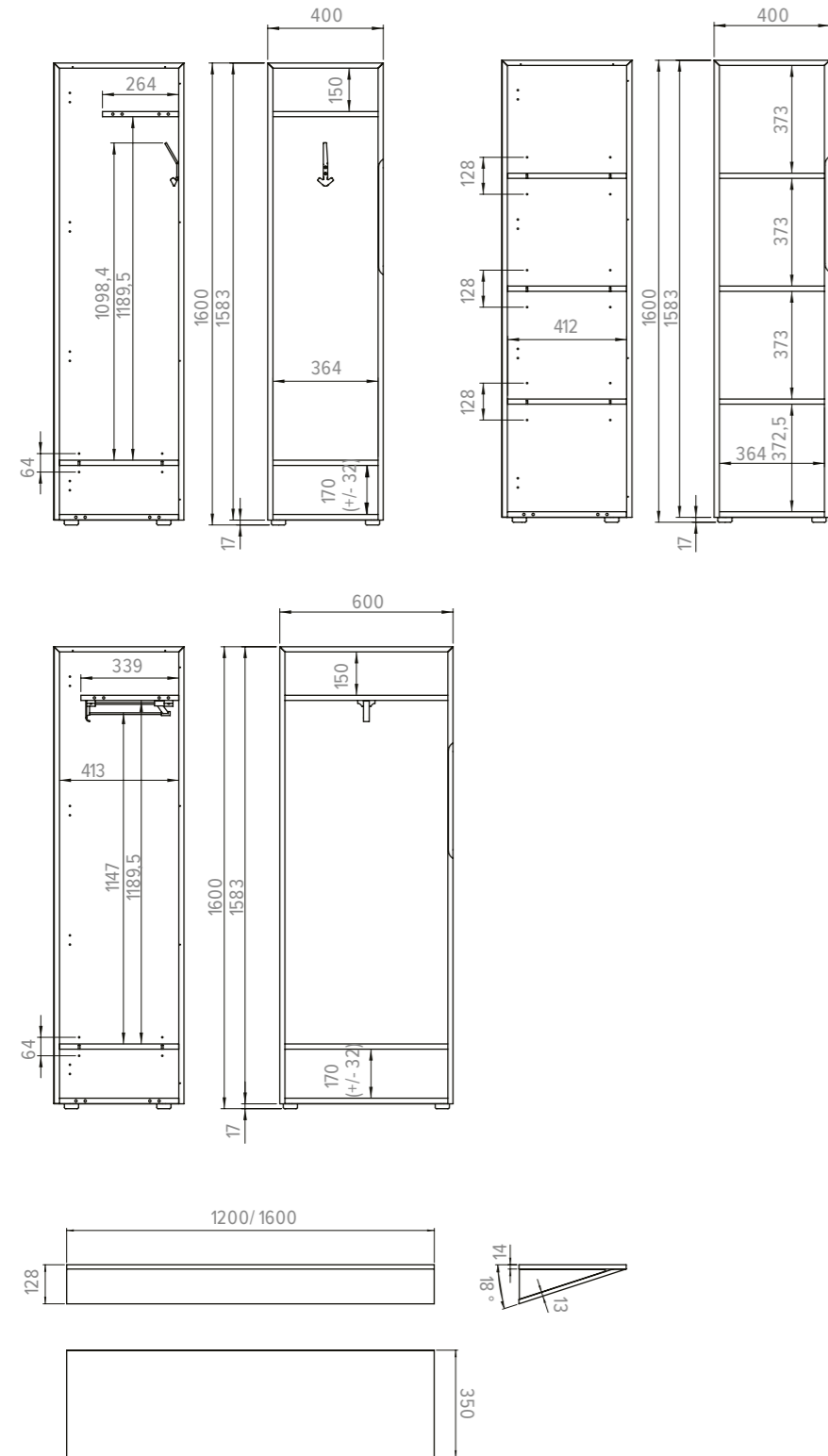

Range

Executive pedestals

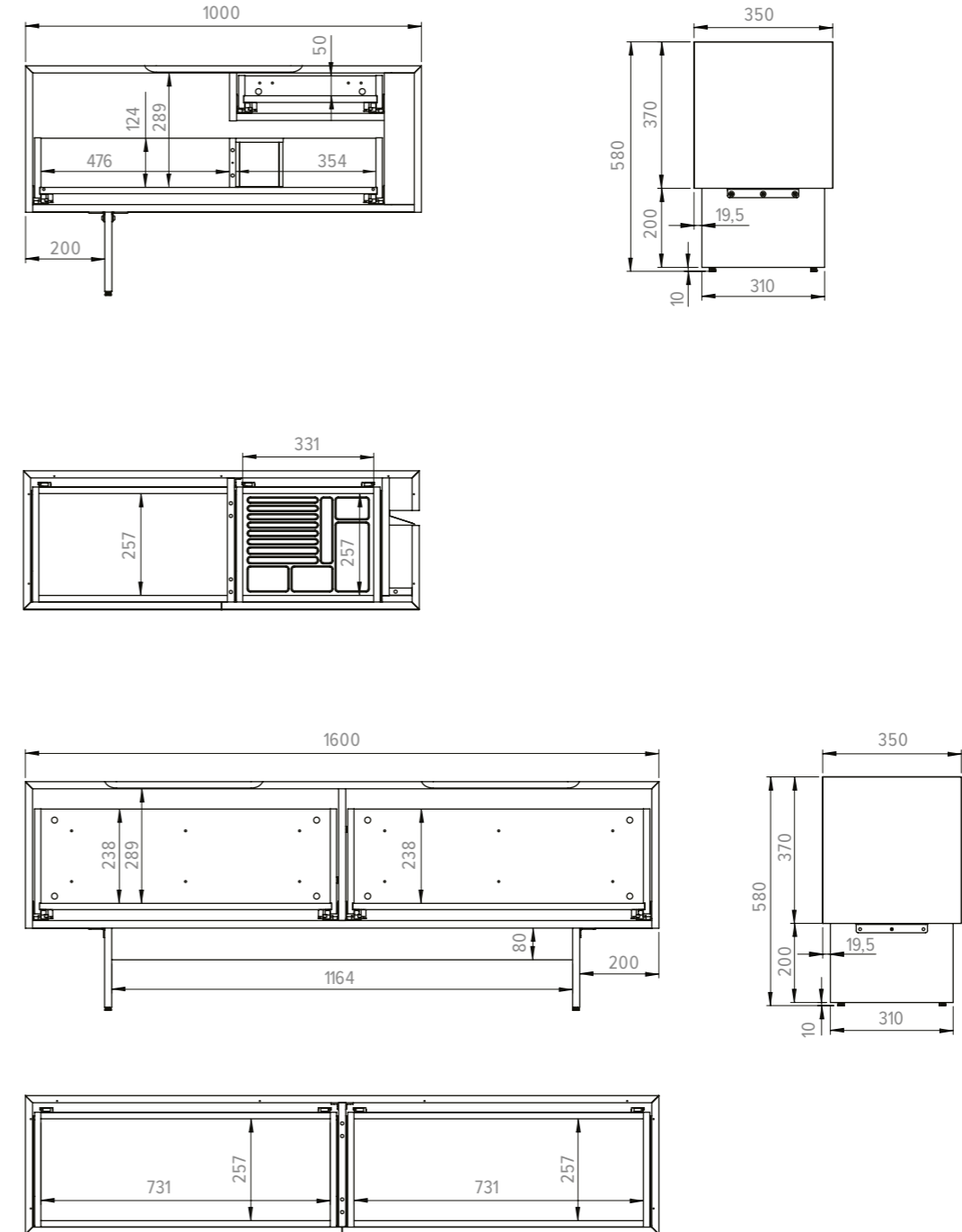

Technical details

DESK

Desktop

- 27mm MDF covered in HPL with sloping edges painted same colour as desktop
- Short sloping edges have 48° angle and the long ones 19° angle

Desktop types

- Desktop with a star type cut-out for grommet and cable management
- Desktop with a star type cut-out for grommet and cable management, with built in wireless charging dock

Internal leg*

- 12mm plywood covered in HPL with brushed stainless steel

External leg

- 12mm plywood covered in HPL (external leg side) and lacquered veneer (inner leg side)
- Black plastic height levelling feet, H10mm (+5mm)

Lid under the desktop

- 12mm plywood covered with lacquered veneer

Cable management and power connectivity

- The electricity supply for the sit-stand desk comes via external leg
- Unique star type cut-out with removable 12mm HPL / veneer cover
- Lid under the desktop with access to hidden power sockets and cable management
- Built-in power sockets for desk and external devices, 2-3 slots for sit-stand desk or 3-4 slots for fixed height desk will be free to use depending on the desk configuration (with or without wireless charging dock)

Inner metal frame

- Metal tube – 53 x 21 mm
- Powder coated metal, black colour by default

Desk control button type – LA*

- Up and down drive
- 2 memory positions
- Automatic drive on memory position
- LED reminder
- Integrated Bluetooth

Lifting columns*

- Anti-collision feature
- Two motors
- Soft start and soft stop
- Lifting speed: up to 38mm/sec
- Lifting capacity: up to 40kg

Control box*

- Input: 117-240V
- Frequency: 53/60Hz
- Output: 18V
- Power Plug: EU, UK, CH, FR, US
- Energy consumption: standby 001W
- Operating Cycle: 1 minute on, 10 minutes off

Fast Qi Wireless charger (built in under the desktop):

- Output: 15W charging
- Qi certified

CABINETS

Carcass

- 18mm chipboard covered in wood veneer
- Milled side panel for convenient door opening
- Natural wood / 05mm veneer lacquered edging

Shelves

- 18mm MFC (melamine) with 1mm ABS edging, coloured in black by default
- Shelf load capacity: 15kg

Doors

- 18mm plywood covered in HPL with lacquered plywood edging
- 164° opening angle with soft closing system

Base

- Black plastic height levelling feet, H17mm (+10mm)

WALL SHELVES

Carcass

- 12mm chipboard covered in HPL Fenix with 1mm ABS edging
- 12mm plywood covered in wood veneer
- 18mm MFC (melamine) with 1mm ABS edging, coloured in black by default
- 25mm MDF
- Load capacity: 10kg

DESK PEDESTAL

Carcass

- 18mm chipboard covered in wood veneer
- 18mm MFC (melamine) with 1 / 1 mm ABS edging, black colour by default
- 18mm MDF covered in wood veneer with 05mm edging
- Milled top panel for convenient drawer opening
- Natural wood / 05mm veneer lacquered edging.

Drawers

- 18mm plywood covered in HPL with lacquered plywood edging
- 18mm plywood covered in wood veneer with lacquered plywood edging
- 15mm chipboard covered in wood veneer with 1 / 2 mm edging
- Pencil drawer bottom is milled and covered in black leather
- Full extension runners with soft closing mechanism
- Drawer load capacity – 10kg
- Removable bottle stand inside the bottom drawer (9mm plywood covered in wood veneer)

Leg

- 16mm chipboard covered in HPL Fenix with 1mm ABS edging
- Black plastic height levelling feet, H10mm (+10mm)

2 DRAWER PEDESTAL

Carcass

- 18mm chipboard covered in wood veneer
- 18mm MFC (melamine) with 1 / 1 mm ABS edging, in black colour by default
- 18mm MDF covered in wood veneer with 05mm edging
- Milled top panel for convenient drawer opening
- Natural wood / 1 mm veneer lacquered edging

Drawers

- 18mm plywood covered in wood veneer with lacquered plywood edging
- 15mm chipboard covered in wood veneer with 1 / 2 mm edging
- Full extension runners with soft closing mechanism
- Drawer load capacity – 10kg

Leg

- 16mm chipboard covered in HPL Fenix with 1mm ABS edging
- Black plastic height levelling feet, H10mm (+10mm)

Materials

HPL Fenix

- Black with black edge (H16B1)
- Grey with grey edge (H17B3)

Band A Veneer

- Walnut (RR)
- Ash stained Black (N61)
- Ash (V1)
- Oak (AA)



Band B Veneer









- Ash stained Dark Brown (N62)
- Walnut stained Grey (N63)

MFC

- Black (J4)

G1: HPL Desktop / Sides + Band A Veneer Insides			G2: HPL Desktop / Sides + Band B Veneer Insides				
	CODE	DESCRIPTION	WIDTH	DEPTH	HEIGHT	G1 (£)	G2 (£)
	BVA180	Executive sit-stand desk (with built-in power socket block, grommet and cover for power socket)	1800	850	735-1300	12,163	12,592
	BVA200		2000	850	735-1300	12,412	12,911
	BVA181	Executive sit-stand desk (with built-in power socket block, grommet, cover for power socket and Qi wireless charging)	1800	850	735-1300	12,859	13,404
	BVA201		2000	850	735-1300	13,120	13,683
	BVA182	Executive fixed desk (with built-in power socket block, grommet and cover for power socket)	1800	850	740	6,740	7,094
	BVA202		2000	850	740	6,978	7,424
	BVA183	Executive fixed desk (with built-in power socket block, grommet, cover for power socket and Qi wireless charging)	1800	850	740	7,430	7,790
	BVA203		2000	850	740	7,680	8,062

G1: Band A Veneer Carcass + HPL Drawer / Leg			G2: Band B Veneer Carcass + HPL Drawer / Leg				
	CODE	DESCRIPTION	WIDTH	DEPTH	HEIGHT	G1 (£)	G2 (£)
	BVF100	Fixed R/H pedestal	1000	350	580	2,883	3,190
	BVF101	Fixed L/H pedestal	1000	350	580	2,883	3,190
	BVF160	Pedestal with 2 drawers <i>IMPORTANT: This pedestal must be fixed either to the wall or any type of adjacent Move cupboard</i>	1600	350	580	3,341	3,707

G1: Band A Veneer Carcass + HPL Door			G2: Band B Veneer Carcass + HPL Door				
	CODE	DESCRIPTION	WIDTH	DEPTH	HEIGHT	G1 (£)	G2 (£)
	BVE040	L/H wardrobe, 3 levels and hanging hook	400	450	1600	3,254	3,625
	BVE041	R/H wardrobe, 3 levels and hanging hook	400	450	1600	3,254	3,625
	BVE060	L/H wardrobe, 3 levels and metal pull-out hanging rail	600	450	1600	3,701	4,107
	BVE061	R/H wardrobe, 3 levels and metal pull-out hanging rail	600	450	1600	3,701	4,107
	BVE043	L/H cupboard, 5 levels	400	450	1600	2,970	3,266
	BVE044	R/H cupboard, 5 levels	400	450	1600	2,970	3,266
	BVE120	Wall mounted shelf	1200	350	128	1,010	1,097
	BVE160		1600	350	128	1,305	1,398
	BVE240	Shelving unit	2400	350	128	2,019	2,199
	BVE320		3200	350	128	2,616	2,796
	ZZZ337	File railings EU/UK/US		423	50	10	116

Plana

Executive Desks / Tables / Storage



Plana is a modern high-quality furniture collection. Straight lines, smooth running forms, warm, refined materials. Aesthetics and functionality create a sense of luxury.

The suspended pedestal storage and modesty panel give the desks a lightweight contemporary feel which is complemented by the open and airy shelf storage.

[See cable management](#)

Range

Executive desks

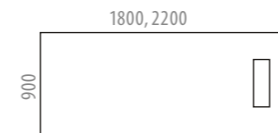
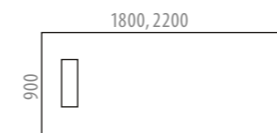

Fixed L/H pedestal

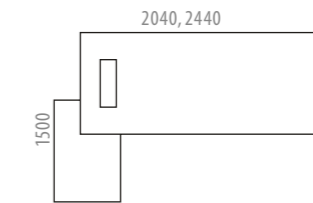

Fixed R/H pedestal

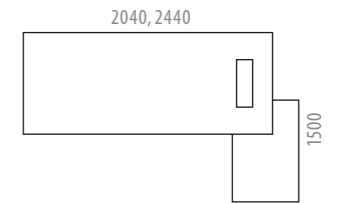

Supplementary unit

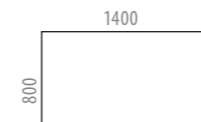

Pedestals

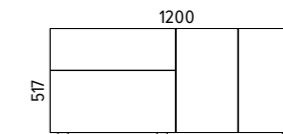
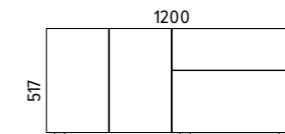
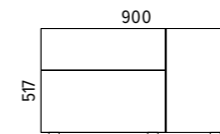
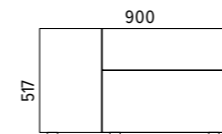

Storage

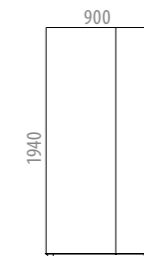
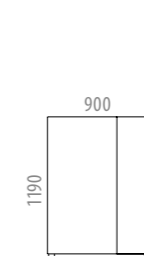
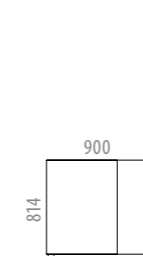
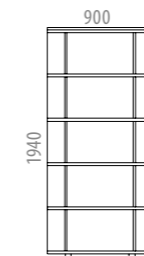
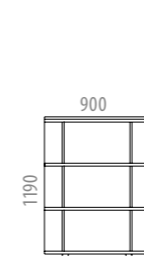
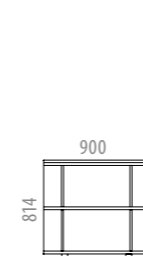

Tables

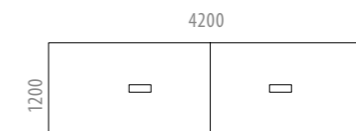
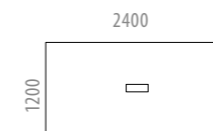
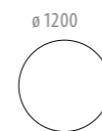

Technical details

DESKS

Supplementary unit

- Affixed with plates to the longer edge of the desktop
- 1,484 x 848 x H795 mm

Desktop

- 36mm MFC with 2mm ABS edging
- 37mm chipboard covered in wood veneer with 15mm edging
- Grain direction runs the length of the desktop
- 1,908 x 954 / 2,332 x 954 mm
- H795 mm
- 445 x 148 mm cut-out for grommet and power socket box

Modesty panel

- 36mm MFC with 2mm ABS edging
- 37mm chipboard covered in wood veneer with 15mm edging

Legs

- Folded steel band - 64 x 11 mm
- Powder coated metal or polished chrome
- Hard felt pads glued to the bottom of the legs, H10mm
- Metal to metal fixings

Rectangular grommet with metal frame

- 18mm MFC or 19mm chipboard covered in wood veneer matching the desktop
- Grommet dimensions - 403 x 143 mm
- Hinges with soft closing
- Folded steel band metal frame – 12mm width on top
- Metal frame dimensions - 472 x 170mm
- Powder coated metal or polished chrome

Box for power module

- 16mm MFC or chipboard covered in wood veneer matching the desktop
- Inside dimensions – 445 x 154 x H115mm (incl. desktop)
- Ø60mm round black plastic cable port at the centre of long side

Fixed pedestals

- 954 x 636 mm with two drawers and a pull-out drawer for suitcase, handbag or computer case
- L/H (left) or R/H (right)
- Base leg made of folded steel band - 64 x 8 mm
- H615mm (carcass – 500mm base leg – 115mm)

TABLES

Tabletop

- 36mm MFC with 2mm ABS edging
- 37mm chipboard covered in wood veneer with 15mm edging
- Grain direction runs the length of the tabletop
- H750mm
- 445 x 148 mm cut-out for grommet and power socket box

Legs

- Folded steel band - 64 x 11 mm
- Powder coated metal or polished chrome
- Hard felt pads glued to the bottom of the legs, H10mm
- Fastened with screws - metal-to metal-construction

Rectangular grommet with metal frame

- 18mm MFC or 19mm wood veneer matching the tabletop
- Grommet dimensions - 403 x 143 mm
- Hinges with soft closing
- Folded steel band metal frame - 12mm width on top
- Metal frame dimensions - 472 x 180 mm
- Powder coated metal or polished chrome

Box for power module

- 16mm MFC or wood veneer matching the tabletop
- Inside dimensions – 445 x 154 x H122 mm (incl. tabletop)
- Ø60mm round black plastic cable port at the centre of the long side

PEDESTALS

- 954 x 636 mm with two drawers and a pull-out drawer for suitcase, handbag or computer case
- 1,272 x 636 mm with two drawers and height adjustable shelf with double doors
- L/H (left) or R/H (right)
- H517mm

Carcass

- 18mm MFC with 1mm ABS edging
- 19mm chipboard covered in wood veneer with 15mm edging
- Grain direction runs horizontally
- Top panel lowered by 20mm
- Grain direction of the top panel matches the tabletop

Facade and back panels

- Combination of 19/20 mm & 25mm thickness panels
- 19/27 mm MFC with 1/2 mm ABS edging
- 20/27 mm chipboard covered in wood veneer with 15mm edging
- Grain direction runs horizontally

- Asymmetrical composition of the facade and the back panels
- Doors - hinges with soft closing function, 101° opening angle

Drawers

- 16mm MFC with 1 mm ABS edging
- 16mm chipboard covered in wood veneer with 15mm edging
- Maximum drawer load - 30kg
- Pull-out and top drawers - full extension rails with soft closing
- Bottom drawer - rails with rejection and opening system TIP-ON (no handles)
- The inside of the top drawer is coated with black genuine leather

Base

- Black plastic height levelling feet, adjustable from inside, H18 mm (+8mm)
- The specified height of the unit includes the height of the feet

STORAGE

Open shelf units

- 3 height levels - 2H/3H/5H
- Dimensions: 954 x 424 mm, H863 / 1,261 / 2,059 mm

Back and vertical panels

- 18mm MFC with 1mm ABS edging
- 19mm chipboard covered in wood veneer with 15mm edging
- Grain direction runs the length of the shelves

Fixed shelves

- 25mm MFC with 2mm ABS edging
- 25mm chipboard covered in wood veneer with 15mm edging
- Grain direction runs the length of the edge
- Top shelf lowered by 20mm

Closed cabinets

- Dimensions: 954 x 424 x H863 / 1,261 / 2,059 mm

Carcass

- Back and side panels - 18mm MFC with 1 mm ABS edging or 19mm chipboard covered in wood veneer with 15mm edging, the grain direction runs horizontally
- Fixed shelves - 25mm MFC with 2mm ABS edging or chipboard covered in wood veneer with 15mm edging, the grain direction runs the length of the edge
- Top panel lowered by 20mm
- Metal pull-out hanging rail inside wardrobe

Doors

- Combination of different thickness panels - 19 / 20 mm (600mm wide) and 25mm (300mm wide)
- 19 / 27 mm MFC with 1 / 2 mm ABS edging
- 20 / 27 mm chipboard covered in wood veneer with 15mm edging
- Grain direction runs horizontally
- Hinges with soft closing system, opening angle - 101°
- The doors of 5H cabinets have a mechanical opening system TIP-ON (no handles)
- Doors have symmetrical construction so the 600mm and 300mm wide doors can be switched (except wardrobe)

Base

- Black plastic height levelling feet, adjustable from inside - H17mm (+8mm)
- The specified height of the unit includes the height of the feet

Materials

Band A MFC

- Whitened Oak (D1)
- Amber Oak (D2)
- White (M1)
- Dark Grey (N1)
- Pearl Grey (N3)

Band B MFC

- Sand Ash (D3)
- Dark Walnut (D4)
- Grey Wood (D5)
- Cubanit Grey (N2)
- Black (J4)

Band A Veneer

- Ash (V1)
- Oak (AA)
- Walnut (RR)

Band B Veneer









- Ash (V1)
- Oak (AA)
- Walnut (RR)









Band A Metal





- Anthracite (T1)
- Black (A)
- Deep Bronze (S1)
- Grey (M)
- White (E)

Band B Metal



- Chrome (H)





G1: Band A MFC Top + Band A Metal G2: Band A MFC Top + Band B Metal		G3: Band B MFC Top + Band A Metal G4: Band B MFC Top + Band B Metal							
	CODE	DESCRIPTION	WIDTH	DEPTH	HEIGHT	G1 (£)	G2 (£)	G3 (£)	G4 (£)
	BPA180/P1	R/H desk (with grommet and box for power module)	1800	900	750	2,166	4,398	2,400	4,668
	BPA220/P1		2200	900	750	2,310	4,488	2,592	4,794
	BPA181/P1	L/H desk (with grommet and box for power module)	1800	900	750	2,166	4,398	2,400	4,668
	BPA221/P1		2200	900	750	2,310	4,488	2,592	4,794
	BPA182/P1	R/H desk with modesty panel (with grommet and box for power module)	1800	900	750	2,100	3,954	2,442	4,326
	BPA222/P1		2200	900	750	2,238	4,116	2,628	4,530
	BPA183/P1	L/H desk with modesty panel (with grommet and box for power module)	1800	900	750	2,100	3,954	2,442	4,326
	BPA223/P1		2200	900	750	2,238	4,116	2,628	4,530
	BPD140/P1	Meeting extension for desk (attaches to the central part of desk)	1400	800	750	978	1,758	1,050	1,830
	CPM240/P1	Meeting table, 8 seats (with grommet and box for power module)	2400	1200	750	2,736	5,262	2,940	5,514
	CPM420/P1	Meeting table, 15 seats (with 2 grommets and boxes for power module)	4200	1200	750	4,140	7,392	4,500	7,740
	CPM120/P1	Round meeting table, 3 seats	Ø1200		750	1,254	2,370	1,350	2,466

G1: Band A Veneer Top + Band A Metal G2: Band A Veneer Top + Band B Metal		G3: Band B Veneer Top + Band A Metal G4: Band B Veneer Top + Band B Metal							
	CODE	DESCRIPTION	WIDTH	DEPTH	HEIGHT	G1 (£)	G2 (£)	G3 (£)	G4 (£)
	BPA180/P2	R/H desk (with grommet and box for power module)	1800	900	750	2,592	4,836	2,748	5,112
	BPA220/P2		2200	900	750	2,790	4,956	2,958	5,268
	BPA181/P2	L/H desk (with grommet and box for power module)	1800	900	750	2,592	4,836	2,748	5,112
	BPA221/P2		2200	900	750	2,790	4,956	2,958	5,268
	BPA182/P2	R/H desk with modesty panel (with grommet and box for power module)	1800	900	750	2,736	4,596	2,946	4,932
	BPA222/P2		2200	900	750	2,988	4,860	3,234	5,250
	BPA183/P2	L/H desk with modesty panel (with grommet and box for power module)	1800	900	750	2,736	4,596	2,946	4,932
	BPA223/P2		2200	900	750	2,988	4,860	3,234	5,250
	BPD140/P2	Meeting extension for desk (attaches to the central part of desk)	1400	800	750	1,152	1,932	1,218	2,004
	CPM240/P2	Meeting table, 8 seats (with grommet and box for power module)	2400	1200	750	3,150	5,718	3,438	5,976
	CPM420/P2	Meeting table, 15 seats (with 2 grommets and boxes for power module)	4200	1200	750	4,890	8,208	5,430	9,018
	CPM120/P2	Round meeting table, 3 seats	Ø1200		750	1,500	2,616	1,584	2,700





		G1: Band A MFC Top + Band A Cupboard + Band A Metal		G3: Band A MFC Top + Band B Cupboard + Band A Metal					
		G2: Band A MFC Top + Band A Cupboard + Band B Metal		G4: Band A MFC Top + Band B Cupboard + Band B Metal					
	CODE	DESCRIPTION	WIDTH	DEPTH	HEIGHT	G1 (£)	G2 (£)	G3 (£)	G4 (£)
	BPA200/P1	Desk with fixed R/H pedestal BPF900 (with grommet and box for power module)	2040	1500	750	3,786	6,228	4,026	6,468
	BPA240/P1		2440	1500	750	3,936	6,312	4,176	6,558
	BPA201/P1	Desk with fixed L/H pedestal BPF901 (with grommet and box for power module)	2040	1500	750	3,786	6,228	4,026	6,468
	BPA241/P1		2440	1500	750	3,936	6,312	4,176	6,558
	BPA202/P1	Desk with modesty panel and fixed R/H pedestal BPF900 (with grommet and box for power module)	2040	1500	750	3,720	5,784	3,966	6,024
	BPA242/P1		2440	1500	750	3,858	5,940	4,104	6,180
	BPA203/P1	Desk with modesty panel and fixed L/H pedestal BPF901 (with grommet and box for power module)	2040	1500	750	3,720	5,784	3,966	6,024
	BPA243/P1		2440	1500	750	3,858	5,940	4,104	6,180

		G1: Band B MFC Top + Band A Cupboard + Band A Metal		G3: Band B MFC Top + Band B Cupboard + Band A Metal					
		G2: Band B MFC Top + Band A Cupboard + Band B Metal		G4: Band B MFC Top + Band B Cupboard + Band B Metal					
	CODE	DESCRIPTION	WIDTH	DEPTH	HEIGHT	G1 (£)	G2 (£)	G3 (£)	G4 (£)
	BPA200/P2	Desk with fixed R/H pedestal BPF900 (with grommet and box for power socket)	2040	1500	750	4,026	6,492	4,266	6,738
	BPA240/P2		2440	1500	750	4,212	6,624	4,458	6,864
	BPA201/P2	Desk with fixed L/H pedestal BPF901 (with grommet and box for power socket)	2040	1500	750	4,026	6,492	4,266	6,738
	BPA241/P2		2440	1500	750	4,212	6,624	4,458	6,864



	CODE	DESCRIPTION	WIDTH	DEPTH	HEIGHT	G1 (£)	G2 (£)	G3 (£)	G4 (£)
	BPA202/P2	Desk with modesty panel and fixed R/H pedestal BPF900 (with grommet and box for power socket)	2040	1500	750	4,062	6,150	4,302	6,396
	BPA242/P2		2440	1500	750	4,248	6,360	4,494	6,600
	BPA203/P2	Desk with modesty panel and fixed L/H pedestal BPF901 (with grommet and box for power socket)	2040	1500	750	4,062	6,150	4,302	6,396
	BPA243/P2		2440	1500	750	4,248	6,360	4,494	6,600



		G1: Band A Veneer Top + M1 / N1 / N2 / N3 MFC Cupboard + Band A Metal		G3: Band A Veneer Top + Band B Cupboard + Band A Metal					
		G2: Band A Veneer Top + M1 / N1 / N2 / N3 MFC Cupboard + Band B Metal		G4: Band A Veneer Top + Band B Cupboard + Band B Metal					
	CODE	DESCRIPTION	WIDTH	DEPTH	HEIGHT	G1 (£)	G2 (£)	G3 (£)	G4 (£)
	BPA200/P3	Desk with fixed R/H pedestal BPF900 (with grommet and box for power socket)	2040	1500	750	4,212	6,666	5,484	7,938
	BPA240/P3		2440	1500	750	4,410	6,786	5,682	8,058
	BPA201/P3	Desk with fixed L/H pedestal BPF901 (with grommet and box for power socket)	2040	1500	750	4,212	6,666	5,484	7,938
	BPA241/P3		2440	1500	750	4,410	6,786	5,682	8,058
	BPA202/P3	Desk with modesty panel and fixed R/H pedestal BPF900 (with grommet and box for power socket)	2040	1500	750	4,356	6,426	5,628	7,698
	BPA242/P3		2440	1500	750	4,608	6,684	5,880	7,956
	BPA203/P3	Desk with modesty panel and fixed L/H pedestal BPF901 (with grommet and box for power socket)	2040	1500	750	4,356	6,426	5,628	7,698
	BPA243/P3		2440	1500	750	4,608	6,684	5,880	7,956

G1: Band B Veneer Top + M1 / N1 / N2 / N3 / J4 MFC Cupboard + Band A Metal
 G2: Band B Veneer Top + M1 / N1 / N2 / N3 / J4 MFC Cupboard + Band B Metal
 G3: Band B Veneer Top & Cupboard + Band A Metal
 G4: Band B Veneer Top & Cupboard + Band B Metal





	CODE	DESCRIPTION	WIDTH	DEPTH	HEIGHT	G1 (£)	G2 (£)	G3 (£)	G4 (£)
	BPA200/P4	Desk with fixed R/H pedestal BPF900 (with grommet and box for power socket)	2040	1500	750	4,368	6,936	6,132	8,700
	BPA240/P4		2440	1500	750	4,578	7,098	6,342	8,862
	BPA201/P4	Desk with fixed L/H pedestal BPF901 (with grommet and box for power socket)	2040	1500	750	4,368	6,936	6,132	8,700
	BPA241/P4		2440	1500	750	4,578	7,098	6,342	8,862
	BPA202/P4	Desk with modesty panel and fixed R/H pedestal BPF900 (with grommet and box for power socket)	2040	1500	750	4,566	6,756	6,330	8,520
	BPA242/P4		2440	1500	750	4,854	7,074	6,618	8,838
	BPA203/P4	Desk with modesty panel and fixed L/H pedestal BPF901 (with grommet and box for power socket)	2040	1500	750	4,566	6,756	6,330	8,520
	BPA243/P4		2440	1500	750	4,854	7,074	6,618	8,838

G1: Band A MFC Carcass & Doors
 G2: Band A MFC Carcass + Band B MFC Doors
 G3: Band B MFC Carcass + Band A MFC Doors
 G4: Band B MFC Carcass & Doors







	CODE	DESCRIPTION	WIDTH	DEPTH	HEIGHT	G1 (£)	G2 (£)	G3 (£)	G4 (£)
	BPF900/P1	Pedestal (1 pull-out drawer on the left; 2 drawers on the right, upper drawer lined with genuine leather)	900	600	517	1,458	1,488	1,650	1,680
	BPF901/P1	Pedestal (1 pull-out drawer on the right; 2 drawers on the left, upper drawer lined with genuine leather)	900	600	517	1,458	1,488	1,650	1,680

	CODE	DESCRIPTION	WIDTH	DEPTH	HEIGHT	G1 (£)	G2 (£)	G3 (£)	G4 (£)
	BPF120/P1	Pedestal (2 shelves on the left; 2 drawers on the right, upper drawer lined with genuine leather)	1200	600	517	1,482	1,512	1,692	1,734
	BPF121/P1	Pedestal (2 shelves on the right; 2 drawers on the left, upper drawer lined with genuine leather)	1200	600	517	1,482	1,512	1,692	1,734

G1: M1 / N1 / N3 MFC Carcass + Band A Veneer Doors
 G2: N2 MFC Carcass + Band A Veneer Doors
 G3: Band A Veneer Carcass & Doors
 G4: M1 / N1 / N3 MFC Carcass + Band B Veneer Doors
 G2: N2 / J4 MFC Carcass + Band B Veneer Doors
 G3: Band B Veneer Carcass & Doors







	CODE	DESCRIPTION	WIDTH	DEPTH	HEIGHT	G1 (£)	G2 (£)	G3 (£)	G4 (£)	G5 (£)	G6 (£)
	BPF900/P2	Pedestal (1 pull-out drawer on the left; 2 drawers on the right, upper drawer lined with genuine leather)	900	600	517	1,824	1,878	2,760	1,914	1,962	3,198
	BPF901/P2	Pedestal (1 pull-out drawer on the right; 2 drawers on the left, upper drawer lined with genuine leather)	900	600	517	1,824	1,878	2,760	1,914	1,962	3,198
	BPF120/P2	Pedestal (2 shelves on the left; 2 drawers on the right, upper drawer lined with genuine leather)	1200	600	517	1,902	1,986	2,868	1,980	2,040	3,282
	BPF121/P2	Pedestal (2 shelves on the right; 2 drawers on the left, upper drawer lined with genuine leather)	1200	600	517	1,902	1,986	2,868	1,980	2,040	3,282

G1: Band A MFC Carcass, Shelves, Doors & Back Panel
 G2: Band A MFC Carcass & Shelves + Band B MFC Doors & Back Panel
 G3: Band B MFC Carcass & Shelves + Band A MFC Doors & Back Panel
 G4: Band B MFC Carcass, Shelves, Doors & Back Panel

	CODE	DESCRIPTION	WIDTH	DEPTH	HEIGHT	G1 (£)	G2 (£)	G3 (£)	G4 (£)
	BPE090/P1	Bookcase, 3 levels	900	400	814	390	426	504	546
	BPE091/P1	Bookcase, 4 levels	900	400	1190	546	594	708	762
	BPE092/P1	Bookcase, 6 levels	900	400	1942	822	894	1,068	1,134
	BPE093/P1	Cupboard, 3 levels (without lock)	900	400*	814	462	486	600	630
	BPE094/P1	Cupboard, 4 levels (without lock)	900	400*	1190	948	1,014	1,146	1,212
	BPE095/P1	Cupboard, 6 levels (push to open function, without lock)	900	400*	1942	1,506	1,602	1,812	1,908
	BPE096/P1	Wardrobe (metal pull-out hanging rail and 1 upper shelf on the left; 5 shelves on the right; push to open function; without lock)	900	400*	1942	1,548	1,644	1,872	1,962

G1: M1 / N1 / N3 MFC Carcass + Band A Veneer Doors
 G2: N2 MFC Carcass + Band A Veneer Doors
 G3: Band A Veneer Carcass & Doors

G4: M1 / N1 / N3 MFC Carcass + Band B Veneer Doors
 G2: N2 / J4 MFC Carcass + Band B Veneer Doors
 G3: Band B Veneer Carcass & Doors

	CODE	DESCRIPTION	WIDTH	DEPTH	HEIGHT	G1 (£)	G2 (£)	G3 (£)	G4 (£)
	BPE090/P2	Bookcase, 3 levels	900	400	814	672	786	1,146	1,356
	BPE091/P2	Bookcase, 4 levels	900	400	1190	948	1,116	1,614	1,926
	BPE092/P2	Bookcase, 6 levels	900	400	1942	1,470	1,710	2,502	3,060
	BPE093/P2	Cupboard, 3 levels (without lock)	900	400*	814	744	888	1,428	1,710
	BPE094/P2	Cupboard, 4 levels (without lock)	900	400*	1190	1,440	1,638	2,532	3,060
	BPE095/P2	Cupboard, 6 levels (push to open function, without lock)	900	400*	1942	2,304	2,610	4,026	4,914
	BPE096/P2	Wardrobe (metal pull-out hanging rail and 1 upper shelf on the left; 5 shelves on the right; push to open function; without lock)	900	400*	1942	2,346	2,664	4,068	4,914

Motion Executive

Executive desks / storage



Motion Executive is an electric sit-stand desk system, a combination of modern elegance and thoughtful functionality.

Panel legs hide the space under the desk giving more privacy. The feeling of elegance and sophistication is reinforced by the large desktop, designed for comfort.

Choose from 2 models: veneer looks elegant and is designed for those who appreciate a natural look. The top has a subtly chamfered edge, while side panels wrap the desk making it appear more united and stylish.

The MFC finish has no side panel and looks more simple and modest with ABS edging.

Create a desk to suit your interior with 38 finish combinations. The insert of the leg can be black or grey HPL Fenix or white HPL. For an MFC combination, choose from 8 finishes for the top, while the leg insert can be white, black or pearl grey. Additionally, you can order a modesty panel, matching the top.

For storage space, you can choose a fixed spacious pedestal on the left or right side with different sizes

Range

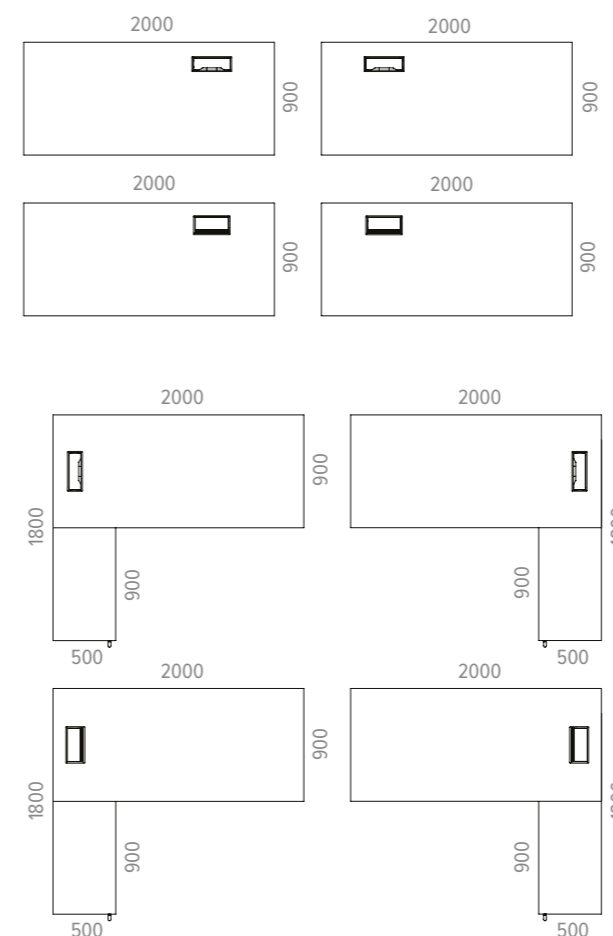

Materials

Band A MFC

Whitened Oak (D1)
Amber Oak (D2)
White (M1)
Pearl Grey (N3)
Dark Grey (N1)

Band B MFC

Sand Ash (D3)
Dark Walnut (D4)
Grey Wood (D5)
Cubanit Grey (N2)
Black (J4)

Panel Leg Insert MFC

White (M1)
Pearl Grey (N3)
Black (J4)

Band A Veneer

Ash (V1)
Ash stained Black (N61)
Oak (AA)
Walnut (RR)

Band B Veneer

Ash stained Dark Brown (N62)
Ash stained Grey (N63)

Panel Leg Insert HPL

White (H70)
Black (H16)
Grey (H17)

Metal

Black (A)
White (E)
Grey (M) - MFC desks only

and drawers available. The largest pedestal opens with a light push and has one height adjustable shelf. Four handle-less drawers add to the clean image.

An easy to reach drawer is situated in the upper corner, convenient for storing your valuables, which can be locked from the side. It is also possible to order fabric insert for the drawer with a choice of colour options.

Spiral cables help to keep things neat. You can access and charge your electronic devices with integrated power modules using flip sockets or grommets.

Motion Executive is fitted with a sensitive gyroscope-based solution that senses both hard and soft obstacles. The anti-collision unit detects even a slight tilt in the desk while it is being raised or lowered.

Adjust the height of the desk by simply pressing the buttons or via a remote Bluetooth control app on your smart device where you can even save your height preferences and be reminded to change your position.

[See cable management](#)

Technical details

Desktop

- 25mm MDF covered in veneer with sloping edges
- 25mm MFC with 2mm ABS edging

Desktop types

- Veneer desktop with matching veneer grommet
- Veneer desktop with flip sockets and USB charger
- Melamine desktop with metal grommet
- Melamine desktop with flip sockets and USB charger

Desk control button types

- MA - up and down drive and 3 memory position
- LA - up and down drive, 2 memory position, automatic drive on memory position, LED reminder, integrated Bluetooth

Panel leg

- Veneer/HPL panel leg - 18mm chipboard covered in veneer. 18mm chipboard inserts covered in HPL. 18mm MFC bottom part (not visible). 15mm veneer edging
- Melamine panel leg – 18mm MFC with 1mm edging

Frame

- L-shaped angle - 60x45x488 mm / 60x60x488 mm / 30x50x477 mm (depending on table configuration)
- Metal tube - 40x21 mm
- Powder coated metal, matches the colour of columns

Lifting columns

- Types: 2 step columns only
- Two motors
- Soft start and soft stop
- Lifting speed: up to 38mm/sec
- Stroke length: 500mm
- Rectangular tube dimensions: 53 x 85 mm
- Lifting capacity: up to 80kg
- Powder coated metal, matches the colour of frame
- Column levellers, up to 10mm
- Columns are covered or integrated into pedestal

PEDESTAL WITH INTEGRATED LEG

Carcass

- Veneer/HPL pedestal - 18mm MDF covered in veneer with 2/1 mm edging
- Veneer/HPL pedestal - 18mm chipboard covered in veneer with 2/1 mm edging
- Melamine pedestal - 18mm MFC with 1mm edging
- 18mm black MFC (melamine) with 1 mm edging (inner not visible parts)

Doors, drawer fronts

- Veneer /HPL pedestal - 16mm chipboard covered in HPL with 1mm edging
- Melamine pedestal - 16mm MFC with 1 mm edging

Inner drawers

- Veneer /HPL pedestal - 12mm chipboard covered in veneer with 05mm edging
- Veneer /HPL pedestal - 16mm chipboard covered in veneer with 05mm edging
- Melamine pedestal - 12mm MFC with 1 mm edging (only black/white colors available)
- Melamine pedestal - 16mm MFC with 1 mm edging (only black/white colors available)

Pedestal features









- Left or right
- Veneer + HPL or MFC
- Integrated table leg
- Full extension runners with soft closing mechanism
- Push open door with adjustable shelf
- Service door (not usable)
- Top drawer with lock
- Drawer load capacity - 10kg
- Carcass edges connected in 48° (veneer version)
- Only black or white inner drawer parts (MFC version)
- Adjustable height levelling feet

Electronic data of power unit for columns









- Input: 117-240V
- Frequency: 53/60Hz
- Output: 18V
- Power Plug: EU, UK, CH, FR
- Energy consumption: standby 001W
- Operating Cycle: 1 minute on, 10 minutes off

Grommet, cable management and power connectivity



- Built-in hidden power sockets or integrated flip sockets with additional USB charger for external devices
- Cable management box under grommet or integrated sockets included
- Spiral power cable attached to panel leg or wired through pedestal (depending on table configuration)

G1: Band A MFC Desktop + Panel Leg Insert		G2: Band B MFC Desktop / Panel Leg					
	CODE	DESCRIPTION	WIDTH	DEPTH	HEIGHT	G1 (£)	G2 (£)
	DRA200	Executive electric height adjustable desk with grommet and box for cable management R/H	2000	900	700-1200	3,688	3,824
	DRA201	Executive electric height adjustable desk with L/H grommet and box for cable management	2000	900	700-1200	3,688	3,824
	DRA202	Executive electric height adjustable desk with R/H integrated sockets	2000	900	700-1200	4,744	4,880
	DRA203	Executive electric height adjustable desk with L/H integrated sockets	2000	900	700-1200	4,744	4,880
	DRB200	Executive height adjustable desk with R/H fixed pedestal with grommet and box for power socket	2000	1800	700-1200	5,582	5,841
	DRB201	Executive height adjustable desk with L/H fixed pedestal with grommet and box for power socket	2000	1800	700-1200	5,582	5,841
	DRB202	Executive height adjustable desk with R/H fixed pedestal with integrated sockets	2000	1800	700-1200	6,644	6,903
	DRB203	Executive height adjustable desk with L/H fixed pedestal with integrated sockets	2000	1800	700-1200	6,644	6,903

G1: Band A MFC		G2: Band B MFC					
	CODE	DESCRIPTION	WIDTH	DEPTH	HEIGHT	G1 (£)	G2 (£)
	DRZ180	Modesty panel (for melamine tables)	1728	16	350	113	142

G1: Band A Veneer Desktop + HPL Panel Leg Insert			G2: Band B Veneer Desktop + HPL Panel Leg Insert				
	CODE	DESCRIPTION	WIDTH	DEPTH	HEIGHT	G1 (£)	G2 (£)
	DRA204	Executive electric height adjustable desk with R/H grommet and box for cable management	2000	900	700-1200	6,266	6,850
	DRA205	Executive electric height adjustable desk with L/H grommet and box for cable management	2000	900	700-1200	6,266	6,850
	DRA206	Executive electric height adjustable desk with R/H integrated sockets	2000	900	700-1200	7,269	7,853
	DRA207	Executive electric height adjustable desk with L/H integrated sockets	2000	900	700-1200	7,269	7,853
	DRB204	Executive height adjustable desk with R/H fixed pedestal with grommet and box for power socket	2000	1800	700-1200	10,255	11,092
	DRB205	Executive height adjustable desk with L/H fixed pedestal with grommet and box for power socket	2000	1800	700-1200	10,255	11,092
	DRB206	Executive height adjustable desk with R/H fixed pedestal with integrated sockets	2000	1800	700-1200	11,264	12,095
	DRB207	Executive height adjustable desk with L/H fixed pedestal with integrated sockets	2000	1800	700-1200	11,264	12,095

G1: Band A Veneer / HPL			G2: Band B Veneer				
	CODE	DESCRIPTION	WIDTH	DEPTH	HEIGHT	G1 (£)	G2 (£)
	DRZ160	Modesty panel (for HPL/veneer tables)	1670	16	350	585	632

G1: Era		G2: Lucia			G3: Velito Presto / Synergy			
	CODE	DESCRIPTION	WIDTH	DEPTH	HEIGHT	G1 (£)	G2 (£)	G3 (£)
	DRZ001	Felt-lined insert for pedestal top drawer	405	337	3	30	42	54
	CODE	DESCRIPTION	WIDTH	DEPTH	HEIGHT	RSP (£)		
	DRZ002	File railing set for one bottom drawer	423	50	10	113		



Tables



Meeting tables

Conference tables

High tables

Media Walls

Coffee tables

Nova Wood HPL table range

Nova

MFC meeting tables



Nova meeting tables are part of the broad-ranging Nova office furniture system.

Intelligently designed table inserts add a functional but playful element which can be a contrasting colour to the desktop and will efficiently conceal cables and sockets.

Range

Meeting Tables

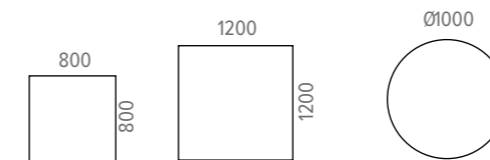
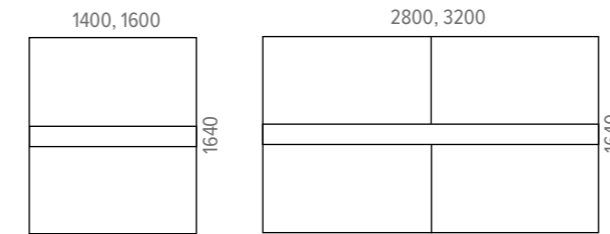

H740 mm

Extensions

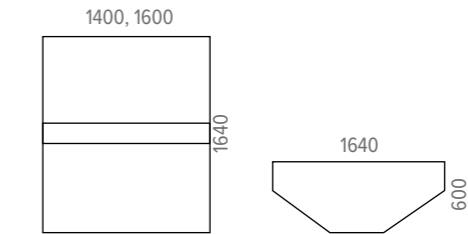

Coffee Table

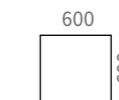

H400 mm

Technical details

Table top

- 25mm chipboard covered in wood veneer or MFC with 2mm ABS edging
- 10mm gap between the legs and the desktop
- Made to match desk height - 740mm
- Inserts made of 25mm MFC with 2mm edging

Metal beam

- 40 x 20 mm metal tube with welded metal plates for leg fixing
- Powder coated metal, colour matches legs

Metal legs

- 40 x 40 mm welded metal tube
- Powder coated metal
- Plastic height levelling feet (+10mm)

Materials

G1: Band A MFC

- Whitened Oak (D1)
- Amber Oak (D2)
- White (M1)
- White with Amber Oak edge (M1D2)
- Pearl Grey (N3)
- Dark Grey (N1)

G2: Band B MFC

- Sand Ash (D3)
- Dark Walnut (D4)
- Grey Wood (D5)
- Cubanit Grey (N2)
- Black (J4)

G3: Band A Veneer









- Ash (V1)
- Oak (AA)
- Walnut (RR)
- Ash stained Black (N61)







G4: Band B Veneer

- Ash stained Dark Brown (N62)
- Walnut stained Grey (N63)

Metal

- Dark Grey (T1)
- Black (A)
- Grey (M)
- White (E)

	CODE	DESCRIPTION	WIDTH	DEPTH	HEIGHT	G1 (£)	G2 (£)	G3 (£)	G4 (£)
	S-BNA140	Meeting table, one piece top	1400	1000	740	650	POA	POA	POA
	S-BNA160		1600	1000	740	668	POA	POA	POA
	BNA180-U		1800	1000	740	568	613	1,031	1,137
	BNA200-U		2000	1000	740	596	645	1,092	1,232
	S-BNA240		2400	1000	740	1,209	POA	POA	POA
	S-CNM140		1400	1200	740	686	POA	POA	POA
	S-CNM160		1600	1200	740	796	POA	POA	POA
	S-CNM180		1800	1200	740	840	POA	POA	POA
	S-CNM200		2000	1200	740	879	POA	POA	POA
	S-CNM240		2400	1200	740	1,290	POA	POA	POA
	S-BNA141	Table Extension	1400	1000	740	747	POA	POA	POA
	S-BNA161		1600	1000	740	766	POA	POA	POA
	S-BNA181		1800	1000	740	783	849	POA	POA
	S-BNA201		2000	1000	740	812	875	POA	POA
	S-BNA241		2400	1000	740	1,308	POA	POA	POA
	S-CNM141		1400	1200	740	786	POA	POA	POA
	S-CNM161		1600	1200	740	898	POA	POA	POA
	S-CNM181		1800	1200	740	945	POA	POA	POA
	S-CNM201		2000	1200	740	981	POA	POA	POA
	S-CNM241		2400	1200	740	1,391	POA	POA	POA
	CNM280-U	Meeting table (10 seats) with a cut-out for insert <i>Meeting table inserts must be ordered</i>	2800	1640	740	1,423	1,563	2,666	2,884
	CNM322-U	Meeting table (12 seats) with a cut-out for insert <i>Meeting table inserts must be ordered</i>	3200	1640	740	1,484	1,641	2,862	3,198
	CNM143-U	Meeting table (6 seats) with a cut-out for insert <i>Meeting table insert must be ordered</i>	1400	1640	740	734	801	1,356	1,462
	CNM163-U	Meeting table (8 seats) with a cut-out for insert <i>Meeting table insert must be ordered</i>	1600	1640	740	762	840	1,456	1,624
	CNM144-U	Meeting table extension <i>Meeting table insert must be ordered</i>	1400	1640	740	678	745	1,294	1,406
	CNM164-U		1600	1640	740	706	784	1,395	1,563

	CODE	DESCRIPTION	WIDTH	DEPTH	HEIGHT	G1 (£)	G2 (£)	G3 (£)	G4 (£)
	ZNZ001	Meeting table insert	1400	180	25	68	79	185	208
	ZNZ002		1600	180	25	79	101	208	224
	ZNZ004	Meeting table insert with cable port cutout <i>Cable port insert (ZNZ010) must be ordered</i>	1400	180	25	68	79	185	208
	ZNZ005		1600	180	25	79	101	208	224
	ZNZ007	Meeting table insert with 2 cable port cutouts <i>Cable port insert (ZNZ010) must be ordered</i>	1400	180	25	68	79	185	208
	ZNZ008		1600	180	25	79	101	208	224
	CNN060-U	Coffee table	600	600	400	241	252	370	398
	CNM080-U	Square meeting table	800	800	740	370	392	577	622
	CNM120-U		1200	1200	740	566	611	964	1,031
	CNM100-U	Circular meeting table	Ø1000	-	740	376	409	639	689

	CODE	DESCRIPTION	WIDTH	DEPTH	HEIGHT	RSP (£)
	ZNZ010	Cable port insert (flap) for 300 x 112 cut-out Available in White, Grey, Black and Dark Grey (metal)	320	130	25	94

Nova Wood

MFC / HPL meeting tables



Nova Wood is a desking system that adds a delicate sense of luxury to your office and brings you closer to nature and a home atmosphere!

Elegant leg design is the key feature of this desking system and every table is unique due to the solid ash wood legs with wide growth rings that create a distinctive pattern. Stained and lacquered wood reveals the pattern even more (natural wood tends to change its colour over time).

The high pressure laminate desktop option features a tapered underside edge portraying a sharp, delicate edge which is softened by curved corners and inset wooden legs in a natural ash finish.

The HPL Fenix finish option is a surface treated with next-generation resins, hardened and fixed through a nanotechnology process giving the surface unique qualities including a super matt finish with low-light reflectivity, an ultra-resistant soft touch surface which is resistant to scratches and abrasion. Any micro scratches can be removed with heating.

Range

MFC top with straight edge

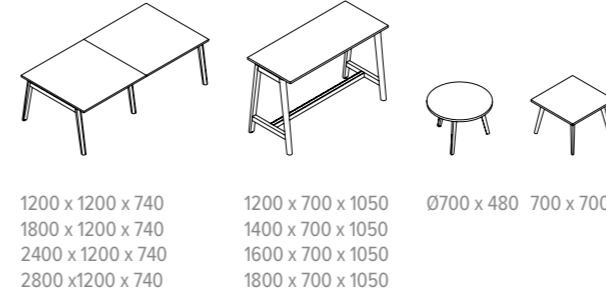

1200 x 1200 x 740
1800 x 1200 x 740
2400 x 1200 x 740
2800 x 1200 x 740

1200 x 700 x 1050
1400 x 700 x 1050
1600 x 700 x 1050
1800 x 700 x 1050

Ø700 x 480 700 x 700 x 480



HPL / HPL Fenix top with rounded chamfered edge

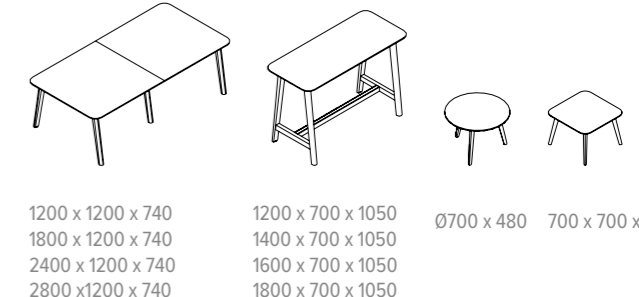

1200 x 1200 x 740
1800 x 1200 x 740
2400 x 1200 x 740
2800 x 1200 x 740

1200 x 700 x 1050
1400 x 700 x 1050
1600 x 700 x 1050
1800 x 700 x 1050

Ø700 x 480 700 x 700 x 480



Materials

Band A MFC

Whitened Oak (D1)
Amber Oak (D2)
White (M1)
White with Amber Oak edge (M1D2)
Pearl Grey (N3)
Dark Grey (N1)

Band B MFC

Sand Ash (D3)
Dark Walnut (D4)
Grey Wood (D5)
Cubanit Grey (N2)
Black (J4)

HPL

White top, black edge (H70B01)
White top, white edge (H70B02)

HPL Fenix

Black top, black edge (H16B01)
Grey top, grey edge (H17B03)

Solid wood

Stained Ash (W2)
Ash stained black (W3)

Metal

Anthracite (T1)
Black (A)
Grey (M)
White (E)

Technical details

Table top







- 25mm MFC with 2mm ABS edging
- 26mm MDF covered in HPL with chamfered painted edges in white or black
- The chamfered edge is on the underside of the table and is 77mm deep tapering from 26mm to 11mm thin at the table edge
- Corners of HPL desktop are rounded: R100 mm
- 10mm gap between the legs and the desktop
- 40mm gap between the desktops in back-to-back benches





Metal beam

- 40 x 20 mm metal tube with welded metal plates for leg fixing
- Powder coated metal, colour matches legs

Legs

- Lacquered and stained natural ash solid wood
- Glued wood construction with metal inserts for fixing
- Plastic height levelling feet (+10mm)
- Central solid wood leg fixed into powder coated metal tube: 120 x 40 mm

		G1: Band A MFC			G2: Band B MFC		
	CODE	DESCRIPTION	WIDTH	DEPTH	HEIGHT	G1 (£)	G2 (£)
	CNM121	Meeting table	1200	1200	740	1,108	1,151
	CNM14A		1400	1400	740	1,420	1,445
	CNM16A		1600	1200	740	1,201	1,218
	CNM16B		1600	1400	740	1,473	1,510
	CNM181		1800	1200	740	1,218	1,262
	CNM24A		2400	1000	740	1,690	1,721
	CNM240		2400	1200	740	1,737	1,817
	CNM281		2800	1200	740	1,786	1,865
	CNM123	Meeting table with central wood insert, removeable cable access panel and metal cable tray	1200	1200	740	1,340	1,370
	CNM14B		1400	1400	740	1,580	1,599
	CNM16C		1600	1200	740	1,466	1,498
	CNM16D		1600	1400	740	1,650	1,668
	CNM183		1800	1200	740	1,506	1,555
	CNM242	Meeting table with central wood insert, 2 removeable cable access panels and 2 metal cable trays	2400	1200	740	2,189	2,250
	CNM283		2800	1200	740	2,272	2,358
	CNM122	Meeting table with socket and metal cable tray	1200	1200	740	1,420	1,456
	CNM14C		1400	1400	740	1,709	1,727
	CNM16E		1600	1200	740	1,522	1,541
	CNM16F		1600	1400	740	1,770	1,806
	CNM182		1800	1200	740	1,562	1,594
	CNM24B	Long meeting table with 2 sockets and 2 metal cable trays	2400	1000	740	2,296	2,327
	CNM241		2400	1200	740	2,354	2,429
	CNM282		2800	1200	740	2,414	2,477
	CNM127	Meeting table with central wood insert, 2 sockets and metal cable tray	1200	1200	740	1,797	1,833
	CNM14D		1400	1400	740	2,103	2,127
	CNM16G		1600	1200	740	1,917	1,955
	CNM16J		1600	1400	740	2,100	2,118
	CNM187		1800	1200	740	1,968	2,017

	CODE	DESCRIPTION	WIDTH	DEPTH	HEIGHT	G1 (£)	G2 (£)
	CNM246	Meeting table with central wood insert, 4 sockets and 2 metal cable trays	2400	1200	740	3,120	3,188
	CNM287		2800	1200	740	3,213	3,300
	CNN070	Round coffee table	Ø700	-	480	375	411
	CNN071	Square coffee table	700	700	480	453	484
	CNM12U	High breakout table	1200	700	900	1,280	1,311
	CNM14U		1400	700	900	1,326	1,356
	CNM16U		1600	700	900	1,369	1,407
	CNM18U		1800	700	900	1,425	1,467
	CNM12A		1200	700	1050	1,339	1,369
	CNM146		1400	700	1050	1,384	1,415
	CNM166		1600	700	1050	1,428	1,466
	CNM18A		1800	700	1050	1,482	1,527

	CODE	DESCRIPTION	WIDTH	DEPTH	HEIGHT	RSP (£)
	CNM14E	Chamfered edge table (HPL Fenix)	1400	1400	740	2,626
	CNM16L		1600	1400	740	2,819
	CNM14G	Chamfered edge table with socket and metal cable tray (HPL Fenix)	1400	1400	740	2,884
	CNM16R		1600	1400	740	3,105

		G1: HPL	G2: HPL Fenix				
	CODE	DESCRIPTION	WIDTH	DEPTH	HEIGHT	G1 (£)	G2 (£)
	CNM124	Chamfered edge table	1200	1200	740	1,432	2,082
	CNM16K		1600	1200	740	1,628	2,378
	CNM184		1800	1200	740	1,685	2,669
	CNM24C		2400	1000	740	2,339	3,162
	CNM243		2400	1200	740	2,347	3,651
	CNM284		2800	1200	740	2,531	4,053
	CNM126	Chamfered edge table with central wood insert, removeable cable access panel and metal cable tray	1200	1200	740	1,638	2,214
	CNM14F		1400	1400	740	2,101	2,713
	CNM16M		1600	1200	740	1,900	2,536
	CNM16N		1600	1400	740	2,197	2,909
	CNM186		1800	1200	740	1,965	2,851
	CNM245	Chamfered edge table with central wood insert, 2 removeable cable access panels and 2 metal cable trays	2400	1200	740	2,851	4,026
	CNM286		2800	1200	740	3,023	4,378
	CNM125	Chamfered edge table with socket and metal cable tray	1200	1200	740	1,732	2,387
	CNM16P		1600	1200	740	1,982	2,643
	CNM185		1800	1200	740	2,115	2,863
	CNM24D	Chamfered edge table with 2 sockets and 2 metal cable trays	2400	1000	740	2,929	3,751
	CNM244		2400	1200	740	2,963	4,268
	CNM285		2800	1200	740	3,153	4,674

	CODE	DESCRIPTION	WIDTH	DEPTH	HEIGHT	G1 (£)	G2 (£)
	CNM128	Chamfered edge table with central wood insert, 2 sockets and metal cable tray	1200	1200	740	2,113	2,689
	CNM14J		1400	1400	740	2,618	3,224
	CNM16S		1600	1200	740	2,407	3,050
	CNM16T		1600	1400	740	2,712	3,417
	CNM188		1800	1200	740	2,424	3,308
	CNM247	Chamfered edge table with central wood insert, 4 sockets and 2 metal cable trays	2400	1200	740	3,790	4,965
	CNM288		2800	1200	740	3,956	5,310
	CNN072	Chamfered edge round coffee table	Ø700	-	480	476	692
	CNN073	Chamfered edge square coffee table	700	700	480	561	784
	CNM12H	Chamfered edge high breakout table	1200	700	900	1,437	1,698
	CNM14H		1400	700	900	1,532	1,830
	CNM16H		1600	700	900	1,607	2,116
	CNM18H		1800	700	900	1,671	2,252
	CNM129		1200	700	1050	1,496	1,757
	CNM147		1400	700	1050	1,592	1,888
	CNM167		1600	700	1050	1,667	2,174
	CNM189		1800	700	1050	1,730	2,311



Nova Wood Multipurpose

MFC / HPL meeting islands

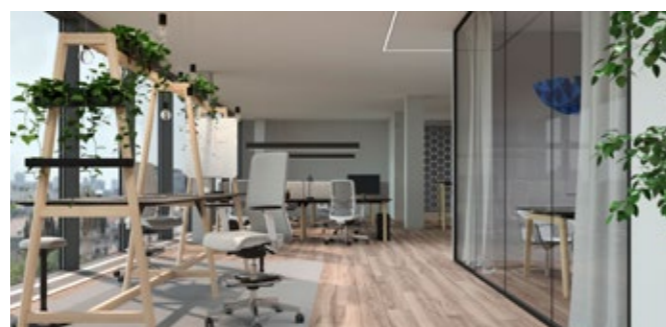

Both high and low multipurpose tables serve as a cosy and stylish, yet practical office island for open meeting spaces. Whether for a brief stand-up meeting, an informal conversation between colleagues, a spontaneous team meeting, a lunch or coffee break in a lounge area – this table will become a point of attraction for your meeting space.

Use optional accessories to create a functional and uniquely styled space. Easily attach a display screen or a writing board to the table legs. Use shelving units to accommodate water bottles or small office supplies.

Office plants placed on top of the shelving units will help to create a more homely and private atmosphere. The electrical solutions integrated into the tabletop will ensure convenient access to power.

Mobility and flexibility are a necessity in today's offices, and you can move the table easily from one place to another using the castors option. The cable tray design will allow for easy and safe storage and handling of the table's electrical power supply elements.

Range

Tables & Extensions with/without castors

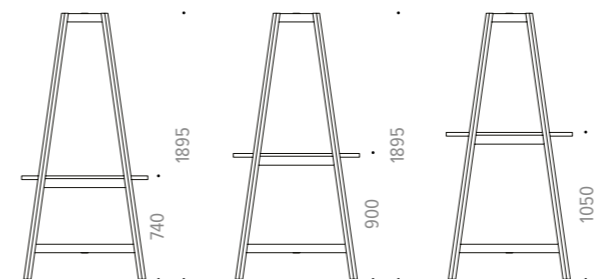
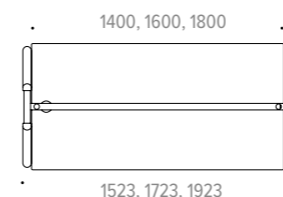
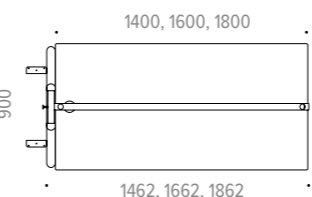

Table tops



Extension table tops



Materials

Band A MFC

Whitened Oak (D1)
Amber Oak (D2)
White (M1)
White with Amber Oak edge (M1D2)
Pearl Grey (N3)
Dark Grey (N1)

Band B MFC

Sand Ash (D3)
Dark Walnut (D4)
Grey Wood (D5)
Cubanit Grey (N2)
Black (J4)

HPL

White top, black edge (H70B01)
White top, white edge (H70B02)

HPL Fenix

Black top, black edge (H16B01)
Grey top, grey edge (H17B03)

Solid wood

Stained Ash (W2)
Ash stained black (W3)

Metal

Dark Grey (T1)
Black (A)
Grey (M)
White (E)

Technical details

Tabletops

- 1.5mm gap between legs and desktop

MFC (melamine)

- 25mm with 2mm ABS edging and R2mm corners

MDF covered in HPL

- 26mm MDF covered in HPL with white or black sloping painted edges and R10mm corners

Metal beam

- Powder coated metal tube with welded metal plates for leg fixing

Legs and central leg

- Lacquered and stained natural ash solid wood
- Glued wood construction with metal inserts for fixing
- Plastic height levelling feet (+10 mm)

Castors

- Four Ø100mm swivel castors with wheel brakes
- Rotate in all directions
- Max load: 100kg per castor

Cable tray (optional)

- W480 x D367 x H68 mm
- Powder coated metal matches colour of frame

Top and bottom side shelves (optional)

- Powder coated metal
- Different shelves for heights: 1100mm and 1456mm
- Max load: 10kg per shelf

Planter box (optional)

- Powder coated metal
- Hang on top table crossbar only
- Not suitable for direct planting
- Max load: 10kg per box

VESA holder (optional)







- Powder coated metal
- Suitable for TV and whiteboard
- Can be placed at H1373mm only
- VESA standard – 100x100 mm
- VESA plate made of 3mm metal sheet (325x325 mm)
- Screen spacers is made of 40x20x2 mm tube
- Recommended screen up to 42", weight up to 15kg
- Screws for fixing screen to VESA plate not included

Whiteboard (optional)





- 14mm MDF covered in HPL with sloping edges



Hook (optional)

- Powder coated metal
- Hang on top table crossbar only
- Max load: 3kg per hook







		G1: Band A MFC		G2: Band B MFC			
	CODE	DESCRIPTION	WIDTH	DEPTH	HEIGHT	G1 (£)	G2 (£)
	DHM140	Table	1523 (1400)	900	1895 (740)	2,258	2,313
	DHM160		1723 (1600)	900	1895 (740)	2,391	2,453
	DHM180		1923 (1800)	900	1895 (740)	2,528	2,596
	DHM141	High table	1523 (1400)	900	1895 (900)	2,254	2,309
	DHM142		1523 (1400)	900	1895 (1050)	2,233	2,290
	DHM161		1723 (1600)	900	1895 (900)	2,381	2,449
	DHM162		1723 (1600)	900	1895 (1050)	2,360	2,434
	DHM181		1923 (1800)	900	1895 (900)	2,525	2,591
	DHM182		1923 (1800)	900	1895 (1050)	2,504	2,571
	DHM143	Table with cut out for socket	1523 (1400)	900	1895 (740)	2,248	2,303
	DHM163		1723 (1600)	900	1895 (740)	2,385	2,447
	DHM183		1923 (1800)	900	1895 (740)	2,528	2,597
	DHM144	High table with cut out for socket	1523 (1400)	900	1895 (900)	2,244	2,300
	DHM145		1523 (1400)	900	1895 (1050)	2,222	2,280
	DHM164		1723 (1600)	900	1895 (900)	2,375	2,441
	DHM165		1723 (1600)	900	1895 (1050)	2,354	2,429
	DHM184		1923 (1800)	900	1895 (900)	2,525	2,593
	DHM185		1923 (1800)	900	1895 (1050)	2,505	2,571
	DHE140	Table extension unit	1462 (1400)	900	1895 (740)	1,612	1,668
	DHE160		1662 (1600)	900	1895 (740)	1,745	1,807
	DHE180		1862 (1800)	900	1895 (740)	1,883	1,950
	DHE141	High table extension unit	1462 (1400)	900	1895 (900)	1,622	1,678
	DHE142		1462 (1400)	900	1895 (1050)	1,625	1,680
	DHE161		1662 (1600)	900	1895 (900)	1,750	1,816
	DHE162		1662 (1600)	900	1895 (1050)	1,752	1,818
	DHE181		1862 (1800)	900	1895 (900)	1,891	1,959
	DHE182		1862 (1800)	900	1895 (1050)	1,895	1,962
	DHE143	Table extension unit with cut out for socket	1462 (1400)	900	1895 (740)	1,602	1,658
	DHE163		1662 (1600)	900	1895 (740)	1,739	1,800
	DHE183		1862 (1800)	900	1895 (740)	1,883	1,952

Dimensions in brackets are table top width and height from ground
Extension units not available with castors



	CODE	DESCRIPTION	WIDTH	DEPTH	HEIGHT	G1 (£)	G2 (£)
	DHE144	High table extension unit with cut out for socket	1462 (1400)	900	1895 (900)	1,611	1,667
	DHE145		1462 (1400)	900	1895 (1050)	1,614	1,670
	DHE164		1662 (1600)	900	1895 (900)	1,742	1,811
	DHE165		1662 (1600)	900	1895 (1050)	1,745	1,812
	DHE184		1862 (1800)	900	1895 (900)	1,892	1,961
DHE185		1862 (1800)	900	1895 (1050)	1,895	1,963	
	DHM14A	Table with castors	1523 (1400)	900	1895 (740)	2,085	2,413
	DHM16A		1723 (1600)	900	1895 (740)	2,244	2,626
	DHM18A		1923 (1800)	900	1895 (740)	2,421	2,847
	DHM14B	High table with castors	1523 (1400)	900	1895 (900)	2,095	2,422
	DHM14C		1523 (1400)	900	1895 (1050)	2,097	2,425
	DHM16B		1723 (1600)	900	1895 (900)	2,253	2,631
	DHM16C		1723 (1600)	900	1895 (1050)	2,255	2,633
	DHM18B		1923 (1800)	900	1895 (900)	2,431	2,856
	DHM18C		1923 (1800)	900	1895 (1050)	2,433	2,858
	DHM14D	Table with cut out for socket and castors	1523 (1400)	900	1895 (740)	2,090	2,418
	DHM16D		1723 (1600)	900	1895 (740)	2,232	2,616
	DHM18D		1923 (1800)	900	1895 (740)	2,402	2,828
	DHM14E	High table with cut out for socket and castors	1523 (1400)	900	1895 (900)	2,100	2,428
	DHM14F		1523 (1400)	900	1895 (1050)	2,102	2,431
	DHM16E		1723 (1600)	900	1895 (900)	2,241	2,618
	DHM16F		1723 (1600)	900	1895 (1050)	2,244	2,620
	DHM18E		1923 (1800)	900	1895 (900)	2,412	2,839
	DHM18F		1923 (1800)	900	1895 (1050)	2,414	2,841









		G1: HPL		G2: HPL Fenix			
	CODE	DESCRIPTION	WIDTH	DEPTH	HEIGHT	G1 (£)	G2 (£)
	DHH140	Table	1523 (1400)	900	1895 (740)	2,730	3,059
	DHH160		1723 (1600)	900	1895 (740)	2,890	3,273
	DHH180		1923 (1800)	900	1895 (740)	3,066	3,493
	DHH141	High table	1523 (1400)	900	1895 (900)	2,726	3,055
	DHH142		1523 (1400)	900	1895 (1050)	2,707	3,035
	DHH161		1723 (1600)	900	1895 (900)	2,884	3,262
	DHH162		1723 (1600)	900	1895 (1050)	2,864	3,242
	DHH181		1923 (1800)	900	1895 (900)	3,062	3,489
	DHH182		1923 (1800)	900	1895 (1050)	3,041	3,469

Dimensions in brackets are table top width and height from ground
Extension units not available with castors

	CODE	DESCRIPTION	G1: HPL		G2: HPL Fenix		
			WIDTH	DEPTH	HEIGHT	G1 (£)	G2 (£)
	DHH143	Table with cut out for socket	1523 (1400)	900	1895 (740)	2,736	3,063
	DHH163		1723 (1600)	900	1895 (740)	2,877	3,261
	DHH183		1923 (1800)	900	1895 (740)	3,048	3,473
	DHH144	High table with cut out for socket	1523 (1400)	900	1895 (900)	2,732	3,060
	DHH145		1523 (1400)	900	1895 (1050)	2,711	3,039
	DHH164		1723 (1600)	900	1895 (900)	2,874	3,250
	DHH165		1723 (1600)	900	1895 (1050)	2,852	3,229
	DHH184		1923 (1800)	900	1895 (900)	3,044	3,470
	DHH185		1923 (1800)	900	1895 (1050)	3,023	3,450
	DHE14A	Table extension unit	1462 (1400)	900	1895 (740)	2,100	2,428
	DHE16A		1662 (1600)	900	1895 (740)	2,244	2,626
	DHE18A		1862 (1800)	900	1895 (740)	2,421	2,847
	DHE14B	High table extension unit	1462 (1400)	900	1895 (900)	2,095	2,422
	DHE14C		1462 (1400)	900	1895 (1050)	2,097	2,425
	DHE16B		1662 (1600)	900	1895 (900)	2,253	2,631
	DHE16C		1662 (1600)	900	1895 (1050)	2,255	2,633
	DHE18B		1862 (1800)	900	1895 (900)	2,431	2,856
DHE18C		1862 (1800)	900	1895 (1050)	2,433	2,858	
	DHE14D	Table extension unit with cut out for socket	1462 (1400)	900	1895 (740)	2,090	2,418
	DHE16D		1662 (1600)	900	1895 (740)	2,232	2,616
	DHE18D		1862 (1800)	900	1895 (740)	2,402	2,828
	DHE14E	High table extension unit with cut out for socket	1462 (1400)	900	1895 (900)	2,100	2,428
	DHE14F		1462 (1400)	900	1895 (1050)	2,102	2,431
	DHE16E		1662 (1600)	900	1895 (900)	2,241	2,618
	DHE16F		1662 (1600)	900	1895 (1050)	2,244	2,620
	DHE18E		1862 (1800)	900	1895 (900)	2,412	2,839
	DHE18F		1862 (1800)	900	1895 (1050)	2,414	2,841
	DHH14A	Table with castors	1523 (1400)	900	1895 (740)	3,186	3,514
	DHH16A		1723 (1600)	900	1895 (740)	3,344	3,727
	DHH18A		1923 (1800)	900	1895 (740)	3,520	3,947

Dimensions in brackets are table top width and height from ground
Extension units not available with castors

	CODE	DESCRIPTION	WIDTH	DEPTH	HEIGHT	G1 (£)	G2 (£)
	DHH14B	High table with castors	1523 (1400)	900	1895 (900)	3,308	3,636
	DHH14C		1523 (1400)	900	1895 (1050)	3,308	3,636
	DHH16B		1723 (1600)	900	1895 (900)	3,467	3,844
	DHH16C		1723 (1600)	900	1895 (1050)	3,466	3,844
	DHH18B		1923 (1800)	900	1895 (900)	3,644	4,071
DHH18C		1923 (1800)	900	1895 (1050)	3,644	4,071	
	DHH14D	Table with cut out for socket and castors	1523 (1400)	900	1895 (740)	3,189	3,518
	DHH16D		1723 (1600)	900	1895 (740)	3,332	3,715
	DHH18D		1923 (1800)	900	1895 (740)	3,502	3,929
	DHH14E	High table with cut out for socket and castors	1523 (1400)	900	1895 (900)	3,313	3,642
	DHH14F		1523 (1400)	900	1895 (1050)	3,313	3,642
	DHH16E		1723 (1600)	900	1895 (900)	3,453	3,833
	DHH16F		1723 (1600)	900	1895 (1050)	3,453	3,831
	DHH18E		1923 (1800)	900	1895 (900)	3,626	4,052
	DHH18F		1923 (1800)	900	1895 (1050)	3,625	4,052

	CODE	DESCRIPTION	WIDTH	DEPTH	HEIGHT	RSP (£)
	DHZ009	HPL Whiteboard with a holder with white HPL front, white or black back, and black, light grey or dark grey metal	600	14	700	356
	DHZ002	Top side shelf H=50	500	100	50	124
	DHZ003	Top side shelf H=100	500	100	100	171
	DHZ004	Bottom side shelf H=50	600	100	50	138
	DHZ005	Bottom side shelf H=100	600	100	100	176
	DHZ006	Planter box	600	150	100	225
	DHZ007	Hook	95	25	83	21
	DHZ008	Monitor holder	482	87	112	162
	DNZ045	Cable tray	480	367	68	166

Dimensions in brackets are table top width and height from ground

Optima tables

MFC meeting tables



Smart and professional, Optima tables are a touch of class on a modest budget.

Optima is an optimal office furniture line which allows you to create a comfortable, functional and well-organized work environment using minimum components. The system includes panel end legs with levelling feet which provides stability on uneven flooring.

All come with 25mm tops, 2mm lippings, a sturdy timber panel base or pole legs with a metal under frame.

Range

Coffee tables with panel leg

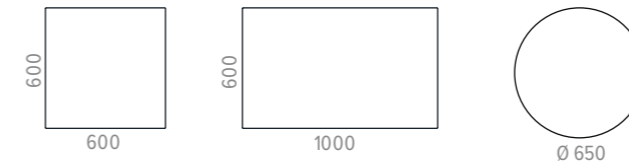

Meeting tables

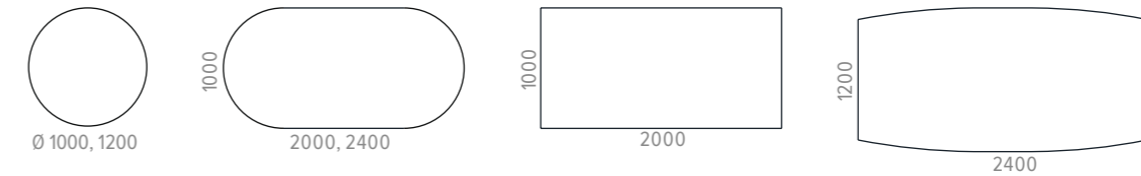

Technical details

Tables with metal pole legs

Tabletop

- 25mm MFC with 2mm ABS edging
- 720mm table height

Metal frame

- 50 x 20mm powder coated metal tube, grey colour by default
- Assembled and fixed to tabletop in the factory

Legs

- Ø50mm Powder coated metal tube
- Plastic height levelling feet (+10mm)
- H695mm leg height

Fittings

- Fast and easy assembly
- Bolted connections (without screws)

Tables with panel legs

Desktop

- 25mm MFC with 2mm ABS edging
- H720mm meeting table, H400mm coffee table

Legs

- 25mm MFC with 2mm ABS edging
- Plastic height levelling feet with (+10 mm)

Panel leg

- 25mm MFC with 0.5mm ABS edging

Fittings

- Cams with connecting bolts.

Materials

G1: Band A MFC









Whitened Oak (D1)
Amber Oak (D2)
White (M1)
Pearl Grey (N3)
Dark Grey (N1)



G2: Band B MFC

Sand Ash (D3)
Dark Walnut (D4)
Grey Wood (D5)
Cubanit Grey (N2)
Black (J4)

Metal

Black (A)
Grey (M)
White (E)

	CODE	DESCRIPTION	WIDTH	DEPTH	HEIGHT	G1 (£)	G2 (£)
	CZM100	Round meeting table with pole leg	Ø1000	-	720	241	255
	CZM120		Ø1200	-	720	303	324
	CZM101	Round meeting table with panel leg	Ø1000	-	720	269	296
	CZM121		Ø1200	-	720	349	392
	CZM200	D-end meeting table with pole leg	2000	1000	720	541	588
	CZM240		2400	1000	720	623	671
	CZM201	D-end meeting table with panel leg	2000	1000	720	464	507
	CZM241		2400	1000	720	517	576
	CZM242	Barrel top meeting table with pole leg	2400	1200	720	688	746
	CZM243	Barrel top meeting table with panel leg	2400	1200	720	582	657
	CZM202	Square-end meeting table with pole leg	2000	1000	720	543	597
	CZM203	Square-end meeting table with panel leg	2000	1000	720	494	537

	CODE	DESCRIPTION	WIDTH	DEPTH	HEIGHT	G1 (£)	G2 (£)
	ZZN603	Square coffee table with panel leg	600	600	400	149	159
	ZZN100	Rectangular coffee table with panel leg	1000	600	400	188	214
	ZZN651	Round coffee table with panel leg	Ø650	-	400	127	154

See
Optima
desks



Opto

Flexible conference tables



Meeting, greeting, training. A flexible modular system of all shapes and sizes.

Whether it's a meeting point on the end of a desk or a complete flexible training room requirement we've got what you need. Individual tables for exams or training - no problem; a conference for 20 - just push the tables together, add some half round ends for an instant result.

Securely connect individual tables with our table connectors, allowing for multiple configurations to suit any scenario.

Our flip-top table frames incorporate an innovative neutrally pivoted release mechanism with integrated adjustable dampening. This results in table tops that are easy to operate and perfectly balanced to minimise premature opening and closing with a controlled 'flipping' action.

Range

Flip-top tables

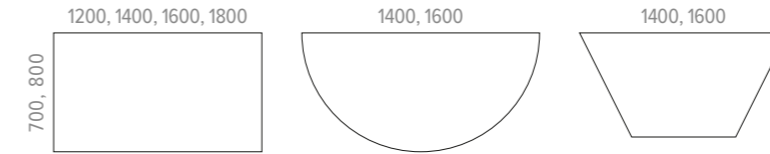

Folding leg tables

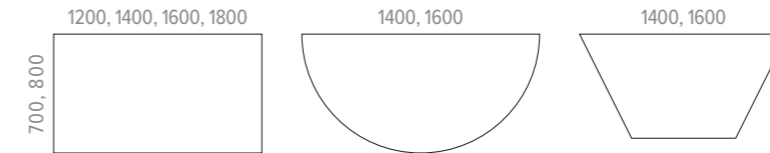

Pole leg tables

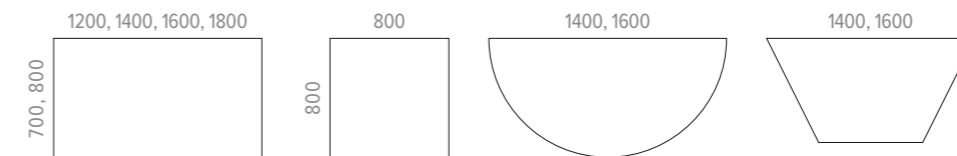

Technical details

Flip-top table frames (DFT)

- Standard leg frames are H695mm (excluding top)
- User friendly release mechanism with smooth controlled 'flipping' action
- Quick and easy to assemble
- Manufactured in UK

Folding leg table frames (DZA)

- 1.2mm thick mild steel tube
- Frame locks in the open position and can be unlocked by releasing the locking lever and snapping them into the retainer – preventing them swinging out
- Plastic blocks allow tables to be stacked without damage

Pole leg table frames (DPL)

- 60mm diameter pole legs
- 30mm height adjustment
- 1.2mm thick mild steel tube
- 200mm top plate

Tabletop

- 25mm MFC with 2mm ABS edging
- 720mm table height

Materials

G1: Band A MFC

- Whitened Oak (D1)
- Amber Oak (D2)
- White (M1)
- White with Amber Oak edge (M1D2)
- Pearl Grey (N3)
- Dark Grey (N1)







G2: Band B MFC



- Sand Ash (D3)
- Dark Walnut (D4)
- Grey Wood (D5)
- Cubanit Grey (N2)
- Black (J4)

Metal

- Grey (SV)
- Black (BK)
- White (WH)

Tops are supplied plain with self tapping screws. Tops with metal inserts available upon request (add £50 to RSP).

	CODE	DESCRIPTION	WIDTH	DEPTH	HEIGHT	G1 (£)	G2 (£)
	DFT122	Rectangular flip-top table with castors	1200	700	720	669	702
	DFT142		1400	700	720	701	748
	DFT162		1600	700	720	745	794
	DFT182		1800	700	720	786	841
	DFT121		1200	800	720	730	771
	DFT141		1400	800	720	773	820
	DFT161		1600	800	720	822	877
	DFT181		1800	800	720	863	921
	DFT183	Round flip-top meeting end with castors	1400	R 700	720	700	741
	DFT180		1600	R 800	720	815	870
	DFT185	Trapezoidal flip-top meeting end with 700mm sides/ends	1400	606	720	664	705
	DFT184	Trapezoidal flip-top meeting end with 800mm sides/ends	1600	693	720	771	818
	DZA122	Rectangular folding leg table	1200	700	720	532	565
	DZA142		1400	700	720	562	609
	DZA162		1600	700	720	598	647
	DZA182		1800	700	720	634	689
	DZA121		1200	800	720	557	598
	DZA141		1400	800	720	598	645
	DZA161		1600	800	720	639	694
DZA181		1800	800	720	675	733	
	DZA183	Round folding leg meeting end	1400	R 700	720	568	609
	DZA180		1600	R 800	720	642	697
	DZA185	Trapezoidal folding leg meeting end with 700mm sides/ends	1400	606	720	532	573
	DZA184	Trapezoidal folding leg meeting end with 800mm sides/ends	1600	693	720	598	645

	CODE	DESCRIPTION	WIDTH	DEPTH	HEIGHT	G1 (£)	G2 (£)
	DPL122	Rectangular pole leg table	1200	700	720	364	397
	DPL142		1400	700	720	394	441
	DPL162		1600	700	720	430	479
	DPL182		1800	700	720	466	521
	DPL081		800	800	720	309	342
	DPL121		1200	800	720	389	430
	DPL141		1400	800	720	430	477
	DPL161		1600	800	720	471	526
	DPL181		1800	800	720	507	565
		DPL183	Round pole leg meeting end	1400	R 700	720	400
DPL180			1600	R 800	720	474	529
	DPL185	Trapezoidal pole leg meeting end with 700mm sides/ends	1400	606	720	364	405
	DPL184	Trapezoidal pole leg meeting end with 800mm sides/ends	1600	693	720	430	477

	CODE	DESCRIPTION	WIDTH	DEPTH	HEIGHT	RSP (£)
	TC2-2	Swivel table connector (1 set of 2pcs.)	-	-	-	28

T-Easy

T-leg meeting tables



An appealing solution for meeting spaces.

T-Easy meeting tables boasting a neutral aesthetic design are ideal for a team of six or eight people. Desks featuring durable construction and T-shaped legs have a clear advantage over other types of desks: they provide a more generous space under and around the desk. The desktops have openings for effective cable and wire management.

T-Easy meeting tables make a great match with fixed height desks from the same system and Easy electric height adjustable desks. This way you will be able to easily integrate today's technology into your meeting areas as T-Easy meeting tables can be used alongside a Media conference wall.

Table range

6 seats

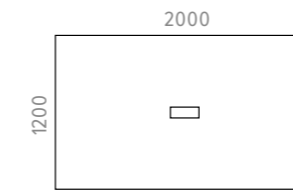

8 seats



Technical details

Tabletop

- 25mm MFC with 2mm ABS edging
- With cut-out for cable flap

Frame

- Metal profile - 40 x 40 mm
- Metal tube - 40 x 20 mm
- Powder coated metal, matches the colour of legs

Columns

- Metal tube - 80x40 mm
- Powder coated metal



Feet type W

- 700 x 70 x H30 mm powder coated metal sheet with welded profile for stability, matches the colour of frame
- Plastic height levelling feet (+10 mm)



Feet type I

- 796 x 60 x H30 mm powder coated metal tube, matches the colour of frame
- Plastic height levelling feet (+10 mm)

Materials

Band A MFC

- Whitened Oak (D1)
- Amber Oak (D2)
- White (M1)
- Pearl Grey (N3)
- Dark Grey (N1)

Band B MFC



- Sand Ash (D3)
- Dark Walnut (D4)
- Grey Wood (D5)
- Cubanit Grey (N2)
- Black (J4)

Metal

- Dark Grey (T1)
- Black (A)
- Grey (M)
- White (E)

G1: Band A MFC Top + Feet type I
G2: Band A MFC Top + Feet type W

G3: Band B MFC Top + Feet type I
G4: Band B MFC Top + Feet type W

	CODE	DESCRIPTION	WIDTH	DEPTH	HEIGHT	G1 (£)	G2 (£)	G3 (£)	G4 (£)
	DZM202	Meeting table (6 seats) with cable port cutout <i>Cable port insert (ZNZ010) must be ordered</i>	2000	1200	740	896	959	1,053	1,115
	DZM242	Meeting table (8 seats) with cable port cutout <i>Cable port insert (ZNZ010) must be ordered</i>	2400	1200	740	1,017	1,079	1,211	1,276

Forum

Column base meeting tables



Possibly the most versatile range of conference tables on the market. Modular tops and bases make for endless size and shape possibilities, infinitely expandable and ideal for larger arrangements, making it easier to find the solution that best meets your needs.

Economic, very stable and durable, the round bases allow effective use of the entire table area and convenient communication with colleagues and partners. Standard base colours available are Black, Grey and White. Minimum order quantities may apply.

Table range

Meeting tables

Ø 800, Ø 900,
Ø 1000, Ø 1100,
Ø 1200, Ø 1400

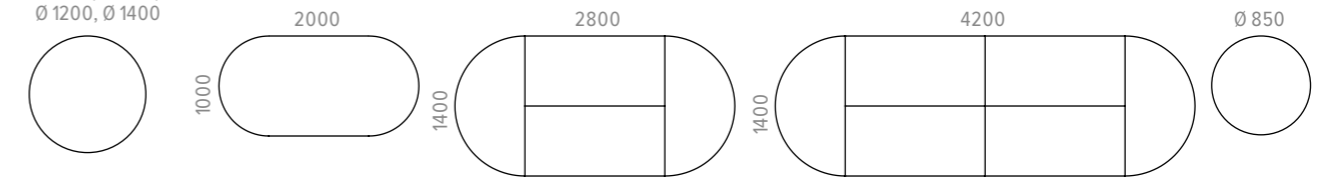

Coffee table

Technical details

Tabletop

- 25mm MFC with 2mm ABS edging
- Table height – 740mm, coffee table height – 440mm

Frame

- Made from welded metal tube – 40 x 30 mm
- Ends covered with black plastic inserts
- Powder coated metal, matches the colour of the column and base
- Fastened with screws

Column

- Round metal tube - Ø76 or Ø115 mm
- Powder coated metal, matches the colour of the frame and base

Base

- Round metal sheet - Ø500, Ø600 or Ø700 mm
- Thickness - 12mm
- Powder coated metal, matches the colour of the frame and column
- Hard felt pads glued to the bottom of the legs

Materials

G1: Band A MFC

Whitened Oak (D1)
Amber Oak (D2)
White (M1)
Pearl Grey (N3)
Dark Grey (N1)

G2: Band B MFC

Sand Ash (D3)
Dark Walnut (D4)
Grey Wood (D5)
Cubanit Grey (N2)
Black (J4)

G3: Band A Veneer



Ash (V1)
Oak (AA)
Walnut (RR)
Ash stained Black (N61)

G4: Band B Veneer





Ash stained Dark Brown (N62)
Walnut stained Grey (N63)



Metal

Black (A)
Grey (M)
White (E)

	CODE	DESCRIPTION	WIDTH	DEPTH	HEIGHT	G1 (£)	G2 (£)
	COM200	Meeting table (8 seats), round ends, double base	2000	1000	740	1,911	1,944
	COM280	Meeting table (10 seats), round ends, double base	2800	1400	740	2,293	2,382
	COM420	Meeting table (14 seats), round ends, triple base	4200	1400	740	3,434	3,569
	COM080	Single column meeting table with Ø500 base	Ø800	-	740	610	610
	COM090	Single column meeting table with Ø700 base	Ø900	-	740	945	951
	COM100	Single column meeting table with Ø700 base	Ø1000	-	740	962	978
	COM110	Single column meeting table with Ø700 base	Ø1100	-	740	982	1,010
	COM120	Single column meeting table with Ø700 base	Ø1200	-	740	1,026	1,043
	COM141	Single column meeting table with Ø700 base	Ø1400	-	740	1,129	1,161

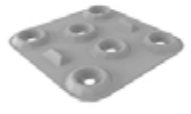
	CODE	DESCRIPTION	WIDTH	DEPTH	HEIGHT	G1 (£)	G2 (£)	G3 (£)	G4 (£)
	CNN080	Single column coffee table	Ø850	-	440	634	649	713	760

	CODE	DESCRIPTION	HEAD	POLE	BASE	HEIGHT	RSP (£)
	DQB050S	Table base for up to Ø1000mm top	Ø600	Ø76	Ø500	415	494
	COT102	Table base for up to Ø800mm top	Ø610	Ø76	Ø500	715	511
	COT101	Table base for up to Ø1100mm top	Ø710	Ø115	Ø700	715	831
	COT100	Table base for up to Ø1400mm top	Ø910	Ø115	Ø700	715	844
	ZIZ001	Joint strengthening plate (1 set, 2pcs.)	-	-	-	-	23

	CODE	DESCRIPTION	WIDTH	DEPTH	HEIGHT	G1 (£)	G2 (£)
	G2A348	Rectangular tabletop	1400	700	25	126	149
	G2A349	Semi-circular tabletop	1400	R700	25	132	153

Air

Meeting tables



Furniture that appears as if floating in thin air.

An exceptional feature of Air tables is the thin profile metal legs that convey a sense of lightness and at the same time ensure their durability and stability. Minimalist Air designs, thought through solutions, combinations of different textures and colours – all this provides more creative freedom for architects who design office spaces.

Air meeting tables feature a round tabletop designed for a team of six people or a rectangular tabletop ideal for eight people.

Range

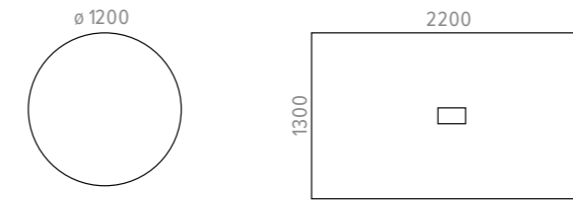

Technical details

Tabletop

- 25mm MFC with 2mm ABS edging
- With or without cut-out for metal grommet

Legs

- Powder coated metal welded metal construction from 12mm tube
- Plastic feet with height levelling (+10mm)

Frame

- 40 x 20 mm Powder coated metal tube, colour matches the legs

Materials

Band A MFC

- Whitened Oak (D1)
- Amber Oak (D2)
- White (M1)
- Pearl Grey (N3)
- Dark Grey (N1)

Band B MFC

- Sand Ash (D3)
- Dark Walnut (D4)
- Grey Wood (D5)
- Cubanit Grey (N2)
- Black (J4)

Band A Veneer

- Ash (V1)
- Ash stained Black (N61)
- Oak (AA)
- Walnut (RR)

Band B Veneer

- Ash stained Dark Brown (N62)
- Walnut stained Grey (N63)

Band A Metal



- Black (A)
- Grey (M)
- White (E)

Band B Metal

- Chrome (H)

- G1: Band A MFC Top + Band A Metal
- G2: Band B MFC Top + Band A Metal
- G3: Band A Veneer Top + Band A Metal

- G4: Band A Veneer Top + Band B Metal
- G5: Band B Veneer Top + Band Metal
- G6: Band B Veneer Top + Band B Metal

	CODE	DESCRIPTION	WIDTH	DEPTH	HEIGHT	G1 (£)	G2 (£)	G3 (£)	G4 (£)	G5 (£)	G6 (£)
	CIM120	Meeting table (6 seats)	Ø1200	-	740	586	616	1,019	1,718	1,118	1,817
	CIM220	Meeting table (8 seats) with cable with cable port cutout <i>Cable port insert (ZNZ010) must be ordered</i>	2200	1300	740	935	996	1,802	2,501	2,014	2,714

Occasional tables

Mobi / Sito / Amber / Novus



Mobi: Compact table

Easily movable and practical Mobi table is ideal for remote working or for relaxing while you wait and browse magazines or enjoy a cup of coffee. Thanks to a wide range of finish options, this table will blend seamlessly with your office interior.

Amber: A flexible and cost-efficient solution

Choose your favourite Amber coffee table with a round or square tabletop.

Sito: Round coffee table

Sito coffee table is an excellent choice for reception and relaxation areas as well as informal meetings. We offer a wide selection of texture options so choose the coffee table that blends seamlessly into your office space.

Novus: Modern clean lines coffee table

Novus coffee table features a laconic and modern design. Another unique feature is a solid tabletop coated with natural veneer.

Range

Novus

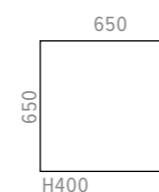

Amber

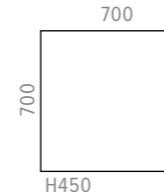

Sito

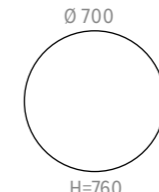

Mobi

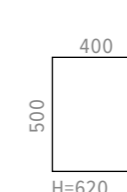

Technical details

Mobi tabletop

- 16mm MFC (500 x 400) with 1mm ABS edging
- 16mm chipboard covered in wood veneer with 1.5mm edging

Leg

- 8mm metal plate under the tabletop
- Vertical column tube (40 x 40 x 2 mm), powder coated metal
- 8mm metal base with 4 adhesive felt glides

Novus tabletop

- 100mm thick chipboard covered in wood veneer

Leg

- Powder coated metal frame
- Plastic pads with height levelling
- Fastened with euro-screws

Amber tabletop

- 18mm MFC with 1mm ABS edging

Legs

- Plywood covered with enamel
- Plastic padding support
- Fastened with bolts

Sito tabletop

- 18mm MFC with 2mm ABS edging
- 19mm chipboard covered in wood veneer with 1.5mm edging

Leg

- Polished chrome round metal base with 50mm metal tube
- Soft padding support
- Fastened with metal plate and bolts

Materials

Band A MFC

- Whitened Oak (D1)
- Amber Oak (D2)
- White (M1)
- Pearl Grey (N3)
- Dark Grey (N1)

Band B MFC

- Sand Ash (D3)
- Dark Walnut (D4)
- Grey Wood (D5)
- Cubanit Grey (N2)
- Black (J4)

Veneer

- Ash (V1)
- Oak (AA)
- Walnut (RR)

HPL

- White top, black edge (H70B01)
- White top, white edge (H70B02)

HPL Fenix

- Black top, black edge (H16B01)
- Grey top, grey edge (H17B03)

Amber legs

- White gloss 30% (U13)

Metal legs

- Dark Grey (T1) - *Novus & Nova Wood only*
- Black (A)
- Grey (M)
- White (E)
- Chrome (H) - *Sito only*

Solid wood

- Stained Ash - *Nova Wood only*
- Ash stained black- *Nova Wood only*

	CODE	DESCRIPTION	G1: Band A MFC Top			G2: Band B MFC Top	
			WIDTH	DEPTH	HEIGHT	G1 (£)	G2 (£)



CZZ700 Amber round coffee table with MFC desktop and plywood legs covered with enamel Ø700 - 450 **342 373**



CZZ701 Amber square coffee table with MFC desktop and plywood legs covered with enamel 700 700 450 **451 477**

G1: Band A MFC Top
G2: Band B MFC Top
G3: Veneer Top

	CODE	DESCRIPTION	WIDTH	DEPTH	HEIGHT	G1: Band A MFC Top G2: Band B MFC Top G3: Veneer Top		
						G1 (£)	G2 (£)	G3 (£)



SHD041 Mobi mobile side table with metal base 400 500 620 **527 540 552**



CZZ702 Sito round coffee table (2-3 seats) with round chromed metal base Ø700 - 760 **940 971 1,097**

Veneer Top

	CODE	DESCRIPTION	WIDTH	DEPTH	HEIGHT	RSP (£)
--	------	-------------	-------	-------	--------	---------



ZZN650 Novus coffee table with veneer top and metal frame base 650 650 400 **1,131**

	CODE	DESCRIPTION	G1: Band A MFC Top			G2: Band B MFC Top	
			WIDTH	DEPTH	HEIGHT	G1 (£)	G2 (£)



CNN070 Nova Wood Round coffee table, MFC top Ø700 - 480 **375 411**



CNN071 Nova Wood Square coffee table, MFC top 700 700 480 **453 484**

G1: HPL Top

G2: HPL Fenix Top

	CODE	DESCRIPTION	WIDTH	DEPTH	HEIGHT	G1: HPL Top		G2: HPL Fenix Top	
						G1 (£)	G2 (£)		



CNN072 Nova Wood HPL chamfered edge round coffee table Ø700 - 480 **476 692**



CNN073 Nova Wood HPL chamfered edge square coffee table 700 700 480 **561 784**



High tables

Light / Jazz / Nova / Nova Wood

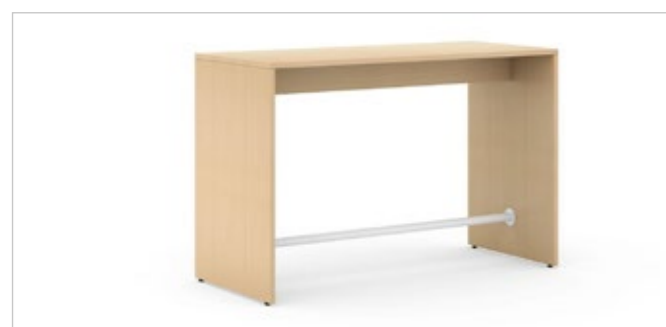

A smart, well thought out range of high tables for canteens and breakout areas.

Available in a variety of styles and sizes to suit every space, including as part of the Nova desk range.

Nova High Table

Designed for leisure and quick meetings, the Nova high table goes in perfect harmony with the Nova furniture collection.

Light High Table

Our Light high table with panel legs is perfect for relaxation or short meeting areas. With its laconic shape and design, this high table blends well with a wide variety of office interiors.

Range

Nova Wood MFC

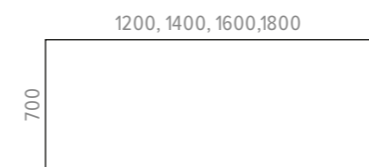

Nova Wood HPL

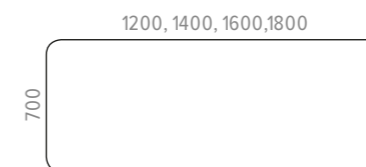

Nova

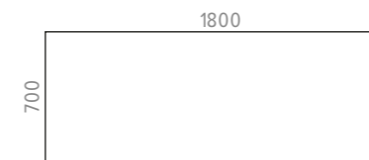

Light



Jazz



Technical details

NOVA WOOD

Tabletop

- 25mm MFC with 2mm ABS edging
- 26mm MDF covered in HPL with chamfered painted edges
- The corners of HPL desktops are rounded: R100mm
- 10mm gap between the legs and the desktop

Frame

- Metal tube - 40 x 20 mm
- With welded metal plates for leg fixing
- Powder coated metal

Central junction

- Dimensions - 60 x 48 mm
- Lacquered and stained natural ash solid wood
- Glued wood construction

Legs

- Lacquered and stained natural ash solid wood
- Glued wood construction
- With metal inserts for fixing
- Plastic feet with height levelling (+10mm)

NOVA

Tabletop

- 25mm MFC (melamine) with 2mm ABS edging

Frame

- Metal tube - 40 x 20 mm
- With welded metal plates for leg fixing
- Powder coated metal, colour matches the legs

Central junction

- Metal tube - 35 x 35 mm
- With welded metal plates for bolt fixing
- Powder coated metal, colour matches the legs

Legs

- Welded metal tubes - 40 x 40 mm
- Powder coated metal
- Plastic feet with height levelling (+10mm)

JAZZ

Tabletop

- 25mm MFC with 2mm ABS edging
- White colour
- 8 mm gap between frame and desktop tabletop.

Metal beam

- Metal tube - 40 x 20 mm
- With welded metal plates for leg fixing
- Powder coated metal, colour matches the legs

Legs

- Metal tube - 70 x 20 mm
- Powder coated metal
- Levelling feet covers made of black lacquered MDF (+10mm)

LIGHT

Tabletop

- 25mm MFC with 2mm ABS edging

Central junction

- Metal tube - 35 x 2 mm
- Side fixing plates - 86mm
- Powder coated metal

Legs

- Plastic feet with height levelling (+10mm)

Materials

Band A MFC

Whitened Oak (D1)
Amber Oak (D2)
White (M1)
Pearl Grey (N3)
Dark Grey (N1)
White with Amber Oak edge (M1D2)
Nova & Nova Wood only

Band B MFC

Sand Ash (D3)
Dark Walnut (D4)
Grey Wood (D5)
Cubanit Grey (N2)
Black (J4)

HPL

White with White edge (H70B01)
White with Black edge (H70B02)

HPL Fenix

Black with Black edge (H16B01)
Grey with Grey edge (H17B03)

Metal legs/frame





Dark Grey (T1) - *Nova only*
Black (A)
Grey (M) - *Light table only*
White (E)

Solid wood - *Nova Wood only*

Stained Ash
Ash stained black

G1: Band A MFC Top

G2: Band B MFC Top

	CODE	DESCRIPTION	WIDTH	DEPTH	HEIGHT	G1 (£)	G2 (£)
	CTM161	Light high panel leg table	1600	700	900	504	600
	CTM181		1800	700	900	535	642
	CTM160		1600	700	1050	519	657
	CTM180		1800	700	1050	557	700
	CGM181	Jazz high loop leg (O frame) table Legs available in Black or White	1800	700	900	921	976
	CGM180		1800	700	1030	941	1,001
	CNM160	Nova high table	1600	700	900	519	548
	CNM18B		1800	700	900	584	629
	CNM165		1600	700	1050	545	574
	CNM180		1800	700	1050	615	654
	CNM12U	Nova Wood high table with MFC top and solid wood legs	1200	700	900	1,280	1,311
	CNM14U		1400	700	900	1,326	1,356
	CNM16U		1600	700	900	1,369	1,407
	CNM18U		1800	700	900	1,425	1,467
	CNM12A		1200	700	1050	1,339	1,369
	CNM146		1400	700	1050	1,384	1,415
	CNM166		1600	700	1050	1,428	1,466
	CNM18A		1800	700	1050	1,482	1,527

G1: HPL Top

G2: HPL Fenix Top

	CODE	DESCRIPTION	WIDTH	DEPTH	HEIGHT	G1 (£)	G2 (£)
	CNM12H	Nova Wood high table with HPL top and solid wood legs	1200	700	900	1,437	1,698
	CNM14H		1400	700	900	1,532	1,830
	CNM16H		1600	700	900	1,607	2,116
	CNM18H		1800	700	900	1,671	2,252
	CNM129		1200	700	1050	1,496	1,757
	CNM147		1400	700	1050	1,592	1,888
	CNM167		1600	700	1050	1,667	2,174
	CNM189		1800	700	1050	1,730	2,311



See Moon stools

Media

Multimedia integration



Media walls are a smart solution to integrate today's technology into your meeting areas, providing a simple way to mount a large screen and manage the power and cabling, especially in an open plan office with minimal wall space.

Media walls give you an easy way to show presentations and to participate in video conferences and meetings. The conference wall can be attached to various types of meeting tables or high tables (brackets included).

You can choose a Media wall with an 80mm cutout for power or cable management.

Technical details

Wall

- Front and back panels made of 16mm MFC
- Sides made of 18mm MFC
- All edges of front & back panels are made of 1mm ABS
- Non-visible edges are 0.5mm ABS
- Back panel fixed to carcass with 25mm MDF
- Four height levelling feet (+10mm)
- 2.5mm metal brackets for connection to tabletops
- Ø60mm round white plastic cable ports

VESA mount

- 100 x 100, 200 x 100, 200 x 200, 300 x 300 mm
- 3mm metal sheet VESA plate (325 x 325 mm) with option for screen height adjustment ±50mm
- Screen/carcass have 40mm space for plugs and wiring
- Screen spacers made of 40 x 20 x 2 mm tube
- Powder coated metal
- Recommended screen up to 42", weight up to 15kg
- Screws for fixing screen to VESA plate are not included

Fixed high table

- Desktop with Ø80mm cut-out for socket
- 25mm MFC (melamine) with 2mm ABS edging
- Plastic feet with height levelling (+10 mm)
- Ø35 x 2 mm powder coated metal frame with Ø86 x 4 mm side fixing plates

Materials

Band A MFC

- Whitened Oak (D1)
- Amber Oak (D2)
- White (M1)
- Pearl Grey (N3)
- Dark Grey (N1)

Band B MFC

- Sand Ash (D3)
- Dark Walnut (D4)
- Grey Wood (D5)
- Cubanit Grey (N2)
- Black (J4)

Metal

- Black (A)
- Grey (M)
- White (E)

- G1: Band A MFC Face & Edge
- G2: Band A MFC Face + Band B MFC Edge
- G3: Band B MFC Face + Band A MFC Edge
- G4: Band B MFC Face & Edge

	CODE	DESCRIPTION	WIDTH	DEPTH	HEIGHT	G1 (£)	G2 (£)	G3 (£)	G4 (£)
	CMZ123	Media wall with VESA mount and Ø80mm cutout for socket <i>Compatible with:</i> T-Easy tables All Jazz tables (except height adjustable) Nova table CNM120-U Nova Executive desks BNA180, BNA200 All Nova Wood tables (except D1400mm)	1200	132	1550	880	898	929	946
	CMZ121	Media wall with VESA mount and white plastic cable port under the table <i>Compatible with:</i> T-Easy tables All Jazz tables (except height adjustable) Nova table CNM120-U Nova Executive desks BNA180, BNA200 All Nova Wood tables (except D1400mm)	1200	132	1550	879	910	927	952
	CMZ124	High Media wall with VESA mount and Ø80mm cutout for socket <i>Compatible with:</i> Jazz high table CGM180 Nova high tables CNM165, CNM180 Nova Wood high tables CNM146, CNM166, CNM18A	1200	132	1860	1,018	1,054	1,082	1,107
	CMZ190	High Media wall with VESA mount, high table (1800 x 800 x H1050 mm) and Ø80mm cutout for socket on the tabletop	1200	132	1860	1,455	1,473	1,556	1,580

Parthos NEW

Acoustic tables



Parthos tables are characterised by a stylish, elegant design, with well-thought-out shapes that spark collaboration. The Parthos collection consists meeting tables, high tables and coffee tables.

The main design element is a sculptural cylindrical column, covered with PET felt, whose textural pattern of vertical lines further emphasises the allusion to the element of classical architecture.

Round power units with different types of sockets can be integrated into the one column meeting tables for

easy charging of devices. For two and three column meeting tables, you can also choose a rectangular metal table grommet for wire management which opens on both sides.

PET felt features acoustic properties; the porous surface absorbs sound, while the vertical cut-outs disperse some of the sound waves. We recommend combining these tables with the Parthos acoustic columns. They will not only ensure a better acoustic environment but will also create stylistically harmonious interiors for meeting, relaxation and other spaces.

Range

Meeting tables

4 / 5 seats

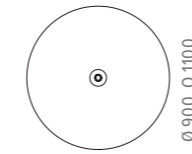
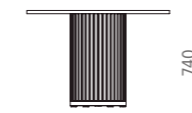

6 / 8 seats

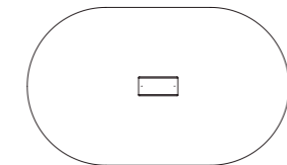
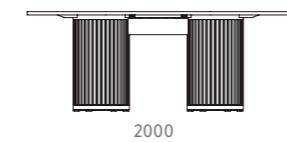

High meeting tables

4 seats

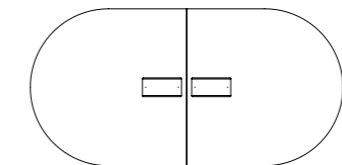
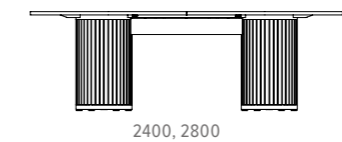
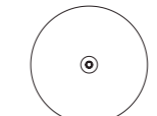
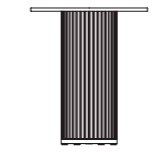

10 / 12 seats

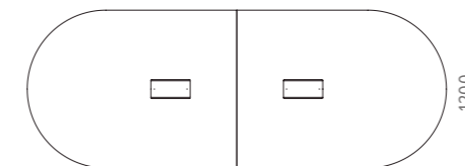
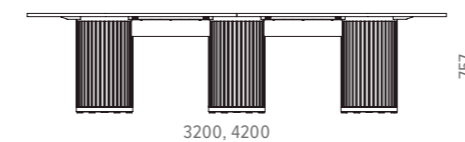

Coffee table

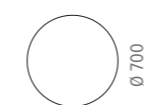

Materials

MFC Top / Grommet Cover

- Whitened Oak (D1)
- Amber Oak (D2)
- White (M1)
- Pearl Grey (N3)
- Dark Grey (N1)
- Sand Ash (D3)
- Dark Walnut (D4)
- Grey Wood (D5)
- Cubanit Grey (N2)
- Black (J4)

HPL Fenix Top

- White / White edge (H70B02)
- White / Black edge (H70B01)
- Grey / Grey edge (H17B03)
- Black / Black edge (H16B01)

HPL Grommet Cover

- White (H70)
- Grey (H17)
- Black (H16)

Metal Grommet

- Black (A)
- Grey (M)
- White (E)
- Dark Grey (T1)
- Deep Bronze (S1)
- Dusty Rose (ME1)
- Avocado Green (ME2)

PET Felt

- Grey (B18)
- Light Grey (B19)
- Green (B44)
- Dark Blue (B50)
- Blue (B51)
- Coral Pink (B56)
- Chestnut (B53)
- Dark Pink (B52)
- Dark Grey (B54)
- Lime (B55)
- Light Grey (B58)
- Light Beige (B57)

Pattern

- Vertical (ZP1)

Base

- Black (J4)

Eco friendly

Technical details

Tabletop

MFC (melamine)

- 25mm with 2mm ABS edging
- The corners of the tabletop are rounded: R2mm
- With or without a cut-out for a grommet and power socket
- Round and obround shaped

MDF covered in HPL

- 26mm MDF covered in HPL with sloping painted edges
- Sloping painted edges: white, black or grey colour
- The bottom edges of the tabletop are sloped 11°
- With or without a cut-out for a grommet and power socket
- Round and obround shaped

Column structure

- The top cover is made of 36mm MFC (melamine) with 2mm ABS edging
- Cover made of PET fiber board, 9mm, with a vertical pattern
- Welded metal frame made of 20x20 mm metal tube, 2mm and 3mm thickness of the metal sheets
- Powder-coated metal
- Base made of 36mm MFC (melamine) with 2mm ABS edging
- Concrete counterweights
- Adjustable height levelling feet, H9 – 14 mm, 6 pcs

Metal frame (under tabletop)

- Welded metal frame made of 40x20 mm metal tube
- Powder coated metal

PET felt cable tray (for two and three column tables)

- PET fiber board of a 9mm thickness
- Bent metal sheet of a 1mm thickness
- Powder-coated metal

Electrical accessories

Rectangular grommet with a metal frame

- 16 mm MFC (melamine) or 17mm MDF covered in HPL covers, matched with the tabletop
- Grommet dimensions – 313x146x27 mm
- Spot welded metal frame made of 1mm and 3mm thick metal sheets
- Powder coated metal
- Two opening directions

		G1: M1 / N1 / N3 MFC Top G2: N2 / J4 MFC Top					G3: H70B01 / H70B02 HPL Fenix Top G4: H17B03/ H16B01 HPL Fenix Top			
	CODE	DESCRIPTION	WIDTH	DEPTH	HEIGHT	G1 (£)	G2 (£)	G3 (£)	G4 (£)	
	CPA190	Meeting table (4 seats)	Ø900		740	1,139	1,150	1,274	1,420	
	CPA192	Meeting table (4 seats) with cut-out for power unit	Ø900		740	1,139	1,150	1,274	1,420	
	CPA110	Meeting table (5 seats)	Ø1100		740	1,191	1,202	1,394	1,607	
	CPA111	Meeting table (5 seats) with cut-out for power unit	Ø1100		740	1,191	1,202	1,394	1,607	
	CPA220	Meeting table (6 seats)	2000	1200	758	2,590	2,616	2,996	3,412	
	CPA221	Meeting table (6 seats) with cut-out for rectangular metal grommet and PET felt cable tray (ZPZ001 must be ordered)	2000	1200	758	2,663	2,689	3,068	3,484	
	CPA222	Meeting table (8 seats)	2400	1200	758	2,720	2,751	3,209	3,708	
	CPA223	Meeting table (8 seats) with cut-out for rectangular metal grommet and PET felt cable tray (ZPZ001 must be ordered)	2400	1200	758	2,886	2,918	3,375	3,874	

G1: M1 / N1 / N3 MFC Top G2: N2 / J4 MFC Top		G3: H70B01 / H70B02 HPL Fenix Top G4: H17B03/ H16B01 HPL Fenix Top							
	CODE	DESCRIPTION	WIDTH	DEPTH	HEIGHT	G1 (£)	G2 (£)	G3 (£)	G4 (£)
	CPA224	Meeting table (8 seats)	2800	1200	758	2,798	2,829	3,360	3,942
	CPA225	Meeting table (8 seats) with cut-out for rectangular metal grommet and PET felt cable tray (ZPZ001 must be ordered)	2800	1200	758	3,053	3,084	3,614	4,197
	CPA330	Meeting table (10 seats)	3200	1200	758	4,004	4,046	4,649	5,315
	CPA331	Meeting table (10 seats) with cut-out for rectangular metal grommet and PET felt cable tray (ZPZ001 must be ordered)	3200	1200	758	4,223	4,264	4,868	5,533
	CPA340	Meeting table (12 seats)	4200	1200	758	4,192	4,254	5,044	5,908
	CPA341	Meeting table (12 seats) with cut-out for rectangular metal grommet and PET felt cable tray (ZPZ001 must be ordered)	4200	1200	758	4,670	4,732	5,523	6,386

	CODE	DESCRIPTION	WIDTH	DEPTH	HEIGHT	G1 (£)	G2 (£)	G3 (£)	G4 (£)
	CPA191	High meeting table (4 seats)	Ø900		1050	1,321	1,326	1,456	1,602
	CPA193	High meeting table (4 seats) with cut-out for power unit	Ø900		1050	1,321	1,326	1,456	1,602
	CPA170	Coffee table	Ø700		480	697	702	780	869

	CODE	DESCRIPTION	WIDTH	DEPTH	HEIGHT	RSP (£)
	ZPZ001	Rectangular metal table grommet with MFC or HPL cover	313	146	27	125
	ZZZ379	Power unit (3 x AC power sockets). Cable length 1.8m.				635
	ZZZ380	Power unit (2 x AC power sockets and 1 x USB type-A+C socket). Cable length 1.8m.				973
	ZZZ381	Power unit (3 x AC power sockets and wireless charger). Cable length 1.8m.				1,066
	ZZZ382	Power unit (2 x AC power sockets, 1 x USB type-A+C socket and wireless charger). Cable length 1.8m.				1,404

Storage



Boxi storage towers

Pedestals

Towers

Cupboards

Bookcases

Wardrobes

Lockers

Cube & Spectrum

Steel mobile pedestal & caddy



Suited under desk these stylish and intelligently designed steel pedestals feature a solid steel construction with central locking, pre-assembled hidden castors and smooth ball bearing runners.

Cube has a slim top and flat front design and the range includes narrow or classic width, and low or standard height, with or without a full box file drawer. Cube is available in White, Grey or Black.

Spectrum Caddy has a unique inset frame and handle design and is available in white with white handles as standard. Upgrade Spectrum handles to a choice of six stock colours or specify any RAL K5 Classic colour*.

formetiq

formetiq

Range

Cube

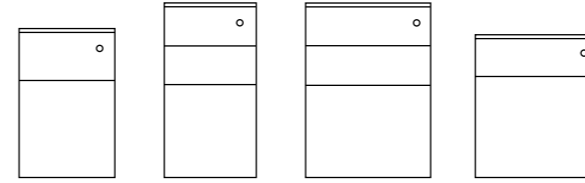

300 x 500 x 495 300 x 500 x 597 410 x 500 x 597 510 x 500 x 597

Spectrum Caddy R/H

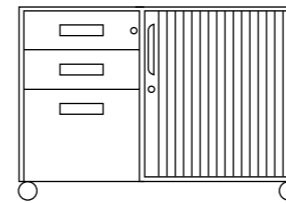

900 x 480 x 645

Spectrum Caddy L/H

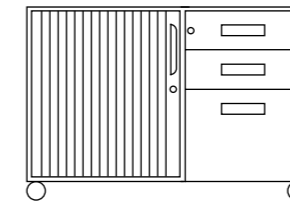

900 x 480 x 645

Technical details

Cube Pedestals

- Drawer dividers and pen tray included
- Four hidden locking castors, supplied fitted
- File drawer can hold A4 or foolscap files
- Central locking
- Soft close drawer runners
- Fit under standard desk
- 5 year warranty
- Certified to BS EN 14073 - 2&3: 2004

Spectrum Caddy

- Lockable tambour door
- L/H or R/H options
- Drawer dividers and pen tray included
- Four castors
- File drawer can hold A4 or foolscap files
- Central locking
- Soft close drawer runners
- Fit under standard desk
- 5 year warranty
- Certified to BS EN 14073 - 2&3: 2004

RAL K5 Classic finish codes

- Black (BK) - RAL: 9017
- White (WH) - RAL: 9016
- Grey (SV) - RAL: 9006
- Red (RD) - RAL: 3020
- Orange (OR) - RAL: 2009
- Yellow (YL) - RAL: 1012
- Green (GR) - RAL: 6018
- Blue (BL) - RAL: 5005

Materials

CUBE

Metal

- Black (BK)
- White (WH)
- Grey (SV)





SPECTRUM CADDY

Metal

- White (WH)

Handles

- Red (RD)
- Orange (OR)
- Yellow (YL)
- Green (GR)
- Blue (BL)
- Black (BK)
- Any RAL K5 Classic colour

	CODE	DESCRIPTION	WIDTH	DEPTH	HEIGHT	RSP (£)	
	PMS4521	Classic pedestal, 2 drawers, 1 file drawer Available in White, Grey and Black	410	500	597	349	
	PMS3521	Narrow pedestal, 2 drawers, 1 file drawer Available in White, Grey and Black	300	500	597	329	
	SMC9521L	L/H caddy unit: 2 drawers, 1 file drawer, 2 shelf cupboard with tambour door, white	900	480	645	550	
	SMC9521R	R/H caddy unit: 2 drawers, 1 file drawer, 2 shelf cupboard with tambour door, white	900	480	645	550	
<p>G1: Black / Orange / Red / Yellow / Green / Blue G2: Any RAL K5 Classic colour</p>							
	CODE	DESCRIPTION	WIDTH	DEPTH	HEIGHT	G1 (£)	G2 (£)
	SHSTC1	Replacement handle for Spectrum Caddy 3 required	-	-	-	12	24

Nova

Pedestals / Cupboards / Lockers



A complete range of system storage to complement the Nova bench desking range.

Cupboards, bookcases, credenzas, locker units. Open fronts, hinged doors, sliding doors, cupboards and other storage exactly designed to fit the desk ends and much, much more.

Nova storage is available in nine different MFC finishes as well as veneer options on some products.

Practical and functional high-capacity shelves and cupboards of different heights and widths can be easily combined in work environments to create various comfortable individual work areas.

Nova Line shelves, cupboards of different heights and widths are decorated with Plexiglas® inserts and handles and will perfectly match any of Narbutas office furniture systems.

Pedestal range

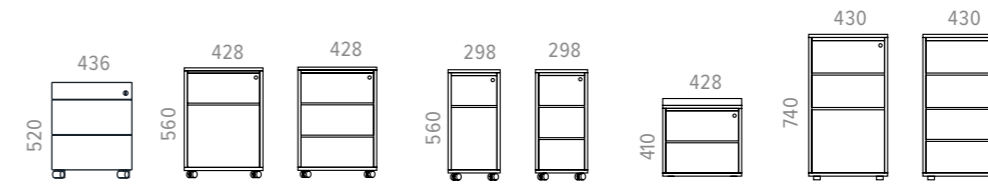

Technical details

Carcass

- Made of 18mm MFC with 1mm ABS edging
- Top panel made of 25mm MFC with 2mm ABS edging

Drawers

- 18mm MFC front
- White 16mm MFC bottom;
- Drawer 1: White metal sided, H86mm x L500mm without a full extension
- Drawer 2: White metal sided, H86mm x L500 mm with a full extension, suitable for A4 and foolscap files
- Central locking (without anti-tilt)
- Anodized aluminium profile handle
- Max. load 25kg for each drawer (except DNF422 which has max. load 15kg for both drawers)

Glides / castors / details

- H740mm: 4 plastic height levelling feet, H23mm +10mm
- H560mm: 4 twin wheel Ø37mm castors, max. load 70kg per castor
- H500mm (DNF530 & DNF531): 2 plastic glides, 2 castors
- H410mm: Fixed under the desktop, with special fixings made from 25mm MFC

Mobile pedestals DNF530 & DNF531

- Plastic pencil drawer included
- No handles
- Silent closing mechanism on DNF531

Materials

Band A MFC

Whitened Oak (D1)
Amber Oak (D2)
White (M1)
Dark Grey (N1)
Pearl Grey (N3)

Band B MFC

Sand Ash (D3)
Dark Walnut (D4)
Grey Wood (D5)
Cubanit Grey (N2)
Black (J4)

Veneer

Oak (AA)
Maple (KK)
Walnut (RR)
Ash (V1)

Metal

Anthracite (T1)
Black (A)
Grey (M)
White (E)

Plexiglas®

White (R01)
Orange (R03)
Light Blue (R06)
Light Green (R07)
Cherry (R08)
Brown (R09)

Cushion Fabric*

Era
Bondai
Lucia
Velito Presto
Syner

Range

Nova Basic

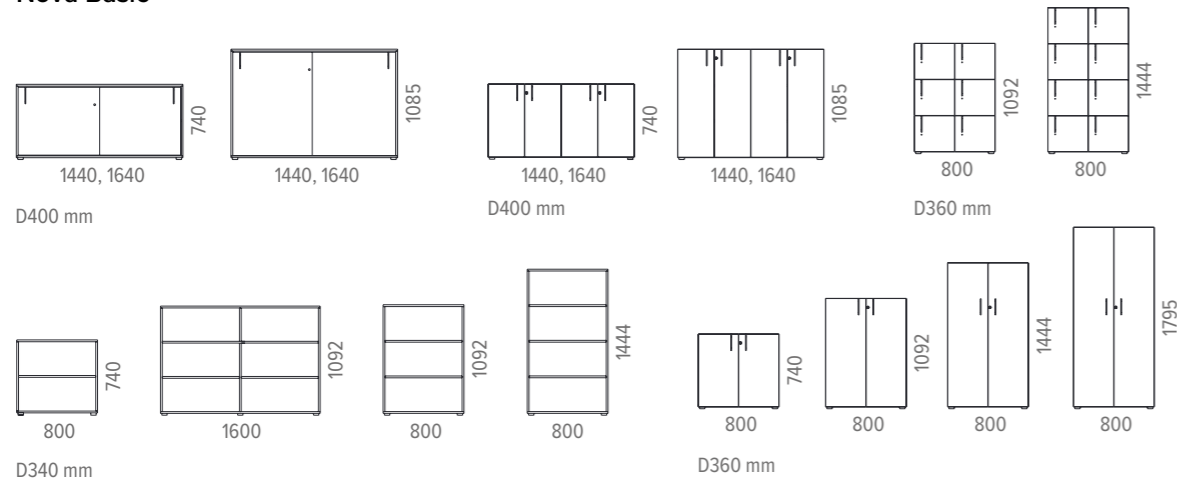

Nova Line

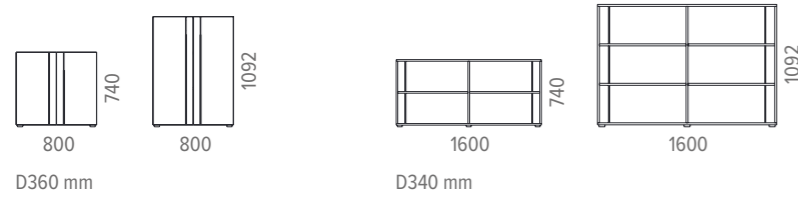

Technical details

Carcass

- 18mm MFC with 1mm ABS edging

Back

- 18mm MFC
- Nova Line cupboard with Plexiglas® insert

Shelves

- 18mm MFC with 1mm ABS edging
- Load capacity 25kg.

Doors

- 18mm MFC with 1mm ABS edging.
- Nova Line cupboard with Plexiglas® insert
- Sliding doors with plastic runners

Fittings

- Cams with connecting bolts
- Lock without metal bars (basic cupboard)
- Fast assembly hinges (no tools required to connect hinges to plates)

Handles

- Powder coated metal, 128mm hole for fixing
- Low profile handle option
- Nova Line handles made from Plexiglas®, 100% recyclable matt surface and long-lasting (resistant to scratching and fingerprints)

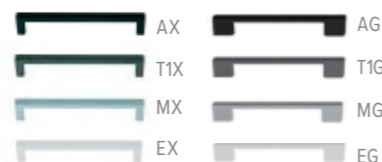

G1: Band A MFC Carcass & Drawers
 G3: Band B MFC Carcass + Band A MFC Drawers
 G5: Band A Veneer Carcass + Band A Veneer / M1 MFC / N2 MFC / N3 MFC / N3 MFC / J4 MFC Drawers



G2: Band A MFC Carcass + Band B MFC Drawers
 G4: Band B MFC Carcass & Drawers
 G6: Band B Veneer Carcass + Band B Veneer / M1 MFC / N2 MFC / N3 MFC / N3 MFC / J4 MFC Drawers



	CODE	DESCRIPTION	WIDTH	DEPTH	HEIGHT	G1 (£)	G2 (£)	G3 (£)	G4 (£)	G5 (£)	G6 (£)
	DNF627	Mobile pedestal with castors, 1 standard drawer, 1 filing drawer	298	600	560	462	473	490	525	1,140	1,296
	DNF626	Mobile pedestal with castors, 1 standard drawer, 1 filing drawer	428	600	560	510	522	544	568	1,158	1,350
	DNF632	Mobile pedestal with castors, 3 standard drawers	428	600	560	470	487	504	539	1,110	1,260
	DNF530	Mobile pedestal with 2 castors and 2 legs, central locking, 3 drawers	436	600	520	545	563	585	620	1,140	1,308
	DNF531	Mobile pedestal with silent closing mechanism, 2 castors and 2 legs, central locking, 3 drawers	436	600	520	597	615	649	678	1,224	1,392

G1: Band A MFC Carcass & Drawers
 G3: Band B MFC Carcass + Band A MFC Drawers
 G5: Band A Veneer Carcass + Band A Veneer / M1 MFC / N3 MFC / N3 MFC / Drawers





G2: Band A MFC Carcass + Band B MFC Drawers
 G4: Band B MFC Carcass & Drawers
 G6: Band B Veneer Carcass + Band B Veneer / M1 MFC / N2 MFC / N3 MFC / N3 MFC / J4 MFC Drawers



	CODE	DESCRIPTION	WIDTH	DEPTH	HEIGHT	G1 (£)	G2 (£)	G3 (£)	G4 (£)	G5 (£)	G6 (£)
	DNF633	Mobile pedestal with castors, 3 standard drawers	298	600	560	428	432	456	484	1,086	1,254





G1: Band A MFC Carcass & Drawers		G3: Band B MFC Carcass + Band A MFC Drawers							
G2: Band A MFC Carcass + Band B MFC Drawers		G4: Band B MFC Carcass & Drawers							
	CODE	DESCRIPTION	WIDTH	DEPTH	HEIGHT	G1 (£)	G2 (£)	G3 (£)	G4 (£)
	DNF422	Fixed pedestal, 2 standard drawers	428	600	410	357	363	392	398
	DNF642	Desk height pedestal with adjustable feet, 4 standard drawers	430	600	740	616	634	674	686
	DNF636	Desk height pedestal with adjustable feet, 2 standard drawers, 1 filing drawer	430	600	740	640	652	704	715

G1: Band A MFC Carcass & Doors		G3: Band B MFC Carcass + Band A MFC Doors							
G2: Band A MFC Carcass + Band B MFC Doors		G4: Band B MFC Carcass & Doors							
	CODE	DESCRIPTION	WIDTH	DEPTH	HEIGHT	G1 (£)	G2 (£)	G3 (£)	G4 (£)
	DNE313	Nova Basic locker unit, 6 lockable doors	800	360	1097	1,024	1,116	1,074	1,165
	DNE410	Nova Basic locker unit, 8 lockable doors	800	360	1449	1,329	1,453	1,393	1,513

	CODE	DESCRIPTION	WIDTH	DEPTH	HEIGHT	G1 (£)	G2 (£)	G3 (£)	G4 (£)
	DNE203	Nova Basic cupboard without lock, 2 levels	800	360	740	390	412	402	429
	DNE213	Nova Basic cupboard with lockable doors, 2 levels	800	360	740	413	452	435	474
	DNE303	Nova Basic cupboard without lock, 3 levels	800	360	1092	492	541	513	562
	DNE317	Nova Basic cupboard with lockable doors, 3 levels	800	360	1092	519	563	557	595
	DNE403	Nova Basic cupboard without lock, 4 levels	800	360	1444	622	660	649	692
	DNE411	Nova Basic cupboard with lockable doors, 4 levels	800	360	1444	653	701	701	745
	DNE501	Nova Basic cupboard without lock, 5 levels	800	360	1795	914	1,000	1,000	1,092
	DNE503	Nova Basic cupboard with lockable doors, 5 levels	800	360	1795	936	1,034	1,039	1,143
	DNE502	Nova Basic wardrobe without lock	800	360	1795	892	984	979	1,072
	DNE216	Nova Basic desk end cupboard with lockable sliding doors, 2 shelves	1440	400	740	580	602	622	652
	DNE320	Nova Basic desk end cupboard with lockable sliding doors, 4 shelves	1440	400	1085	711	753	782	824
	DNE310	Nova Basic desk end cupboard with lockable sliding doors, 4 shelves	1640	400	1085	826	880	946	1,001

	CODE	DESCRIPTION	WIDTH	DEPTH	HEIGHT	G1 (£)	G2 (£)	G3 (£)	G4 (£)
	DNE214	Nova Basic desk end cupboard with lockable doors, 2 shelves	1440	400	740	849	914	892	957
	DNE215		1640	400	740	870	941	934	1,005
	DNE318	Nova Basic desk end cupboard with lockable doors, 4 shelves	1440	400	1085	1,050	1,135	1,125	1,211
	DNE319		1640	400	1085	1,109	1,201	1,207	1,293
	DNE202	Nova Line cupboard without lock with 1 shelf (back panel and doors with Plexiglas® insert)	800	360	740	758	839	768	854
	DNE302		800	360	1092	1,196	1,341	1,218	1,358

	CODE	DESCRIPTION	WIDTH	DEPTH	HEIGHT	G1 (£)	G2 (£)
	DNE209	Bookcase, 2 levels	800	340	740	238	253
	DNE309	Bookcase, 3 levels	800	340	1097	296	311



	CODE	DESCRIPTION	WIDTH	DEPTH	HEIGHT	G1 (£)	G2 (£)
	DNE409	Bookcase, 4 levels	800	340	1449	381	408
	DNE305	Double-sided bookcase, 3 levels	1600	340	1092	505	560
	DNE206	Nova Line bookcase (back panel with Plexiglas® insert)	1600	340	740	520	585
	DNE306		1600	340	1092	712	816

G1: Era / Bondai

G2: Lucia

G3: Velito Presto / Synergy

	CODE	DESCRIPTION	WIDTH	DEPTH	HEIGHT	G1 (£)	G2 (£)	G3 (£)
	DNZ002	Cushion for pedestal with hook-and-loop fasteners <i>Not every fabric from above ranges is available - please see Fabrics section at back of price list for details</i>	420	590	32	150	172	213

	CODE	DESCRIPTION	WIDTH	DEPTH	HEIGHT	RSP (£)
	ZZZ058	Master key (1 pc.)	-	-	-	41
	ZZZ059	Removal key (1 pc.)	-	-	-	24
	ZZZ006	Pencil tray for metal sided drawers	368	250	25	39

Optima

MFC Pedestals / Filing Cabinets



Materials

Band A MFC

Whitened Oak (D1)
Amber Oak (D2)
White (M1)
Dark Grey (N1)
Pearl Grey (N3)

Band B MFC

Sand Ash (D3)
Dark Walnut (D4)
Grey Wood (D5)
Cubanit Grey (N2)
Black (J4)

Metal

Anthracite (T1)
Black (A)
Grey (M)
White (E)

Range

Mobile pedestals



Desk height pedestals

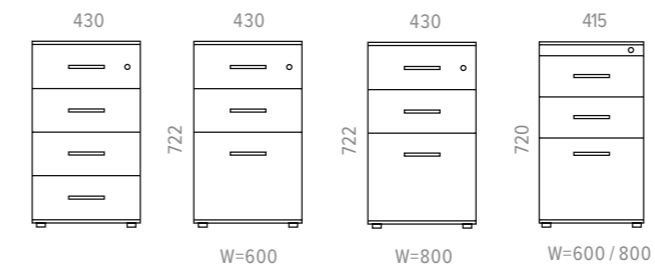

Fixed pedestals

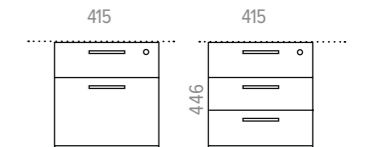

Filing cabinets

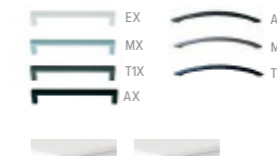
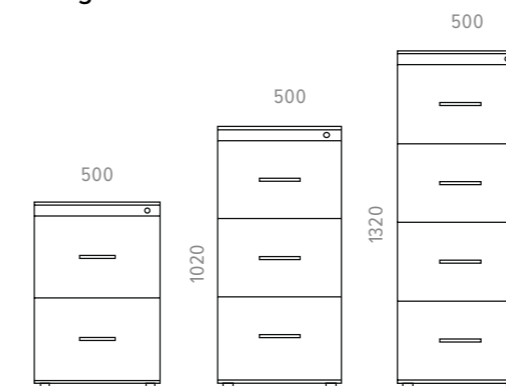

Technical details

Carcass

- Made of 16mm MFC, 1mm ABS edging
- PEX627, PEX637, PEX647 made of 18mm MFC, 1mm ABS edging

Top

- Top made of 25mm MFC, 2mm ABS edging (PUR, PUS, PSS, PEX series)
- Top made of 16mm MFC, 1mm ABS edging (PSR series)

Feet

- Plastic height levelling feet, H38mm +10mm or H23mm +10mm (PSS, PEX series)

Castors

- Ø37mm twin wheel castor
- Max. 50kg per castor









Locks









- Central locking on all pedestals except PSR540



















Drawers

- D450mm foil wrapped drawers: sides made from white 12mm MFC, bottom made from white 4mm fiberboard, max. load 15kg (PSR, PSP series)
- D500mm metal-sided drawers: bottom and back made from white 16mm MFC, max. load 25kg (PUR, PUS series)
- First pencil drawer made from plastic (PUR642)
- File drawer (PUS635, PUS835)
- Full extension file drawer suitable for A4 or foolscap filing (PSR535, PSR525, PUR637, PSS637, PEX series)
- Anti-tilt mechanism (PUR642, PUS642, PUS835, PEX)

	CODE	DESCRIPTION	G1: Band A MFC		G2: Band B MFC		G1 (£)	G2 (£)
			WIDTH	DEPTH	HEIGHT	HEIGHT		
	PSP525	Fixed pedestal, 1 standard drawer, 1 file drawer	415	500	446		282	311
	PSP532	Fixed pedestal, 3 standard drawers	415	500	446		267	302
	PSS637	Desk height pedestal, 2 standard drawers, 1 full extension file drawer	415	600	720		412	462
	PSS837	Deep desk height pedestal, 2 standard drawers, 1 file drawer	415	800	720		467	518
	PSS642	Desk height pedestal, 4 standard drawers	415	600	720		419	458
	PSR525	Mobile pedestal, 1 standard drawer, 1 full extension file drawer	415	500	510		306	342
	PSR532	Mobile pedestal, 3 standard drawers	415	500	510		298	331
	PSR535	Mobile pedestal, 2 standard drawers, 1 full extension file drawer	415	500	638		349	390

	CODE	DESCRIPTION	WIDTH	DEPTH	HEIGHT	G1 (£)	G2 (£)
	PSR540	Mobile pedestal, 4 standard drawers	415	500	638	301	329
	PSR541	Mobile pedestal, 4 standard drawers, central locking	415	500	638	336	376
	PUR636	Heavy duty mobile pedestal, 3 standard drawers	430	600	600	556	627
	PUR642	Heavy duty mobile pedestal, 1 pencil drawer, 3 standard drawers, anti-tilt mechanism	430	600	600	560	631
	PUR637	Heavy duty mobile pedestal, 2 standard drawers, 1 full extension file drawer	430	600	672	577	641
	PUS635	Heavy duty pedestal, 2 standard drawers, 1 file drawer	430	600	722	542	602
	PUS642	Heavy duty pedestal, 4 standard drawers, anti-tilt mechanism	430	600	722	558	633
	PUS835	Deep heavy duty pedestal, 2 standard drawers, 1 file drawer, anti-tilt mechanism	430	800	722	632	726

	CODE	DESCRIPTION	G1: Band A MFC			G2: Band B MFC	
			WIDTH	DEPTH	HEIGHT	G1 (£)	G2 (£)
	PZZ016	Top for desk height pedestals PUS642, PUS635	430	800	25	60	65
	PEX627	Filing cabinet, 2 drawers, desk height, anti-tilt mechanism	500	600	720	486	537
	PEX637	Filing cabinet, 3 drawers, anti-tilt mechanism	500	600	1020	665	734
	PEX647	Filing cabinet, 4 drawers, anti-tilt mechanism	500	600	1320	836	931
	PXA420	Bookcase, 1 shelf, includes feet	800	400	720	180	205
	PXD620	Cupboard with lockable doors, 1 shelf <i>Feet X0Z014 have to be ordered separately</i>	800	600	720	361	402
	PXL620	Cupboard with lockable sliding doors, 1 shelf, includes adjustable plinth	1200	600	720	532	607

	CODE	DESCRIPTION	G1: Band A MFC Carcass & Drawers				G2: Band A MFC Carcass + Band B MFC Drawers				G3: Band B MFC Carcass + Band A MFC Drawers				G4: Band B MFC Carcass & Drawers			
			WIDTH	DEPTH	HEIGHT	G1 (£)	G2 (£)	G3 (£)	G4 (£)	WIDTH	DEPTH	HEIGHT	G1 (£)	G2 (£)	G3 (£)	G4 (£)		
	PGR636	Mobile pedestal (3 standard drawers, central locking; anti-tilt)	432	600	594	768	772	803	808									
	PGR836		432	800	594	879	894	921	925									
	PGR640	Mobile pedestal (1 pencil drawer; 3 standard drawers; central locking; anti-tilt)	432	600	594	845	860	880	886									
	PGR840		432	800	594	954	965	1,000	1,000									
	PGR632	Mobile pedestal (1 pencil drawer; 1 standard drawer and file drawer; central locking; anti-tilt)	432	600	594	782	796	816	822									
	PGR832		432	800	594	899	905	941	941									
	CODE	DESCRIPTION	WIDTH	DEPTH	HEIGHT	RSP (£)												
	ZZZ004	Pen tray for desk height and mobile pedestals PSR/PSS	335	235	35	23												
	ZZZ006	Pen tray for heavy duty pedestals PUR/PUS	368	250	25	39												
	X0Z014	5 plastic legs for W1200mm cupboards	-	-	23	17												
	PZZ017	4 height adjusting feet for PUS642, PUS635, PUS835 Increases pedestal height to 740mm	-	-	20	16												

Boxi

Tower storage

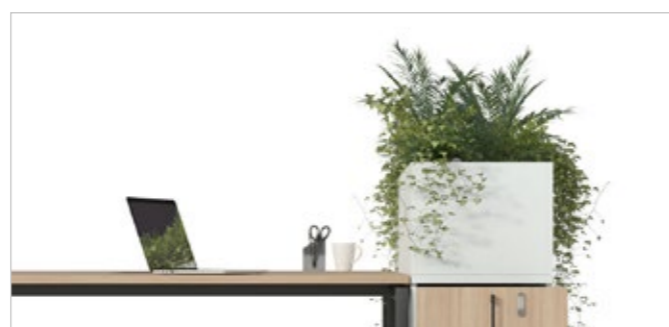

Minimalist style. Unlimited possibilities. A simple and universal solution designed to accommodate all your essentials in the office. Thanks to its storage capacity Boxi can be adapted to meet specific storage needs and ensure that all essentials are within reach.

- 2 widths: 360mm or 420 mm
- 2 depths: 800mm (for single desks) or 820mm (for bench desks)
- 3 heights: 740mm (desk height), 1090mm and 1200mm
- Different inner combinations

Range

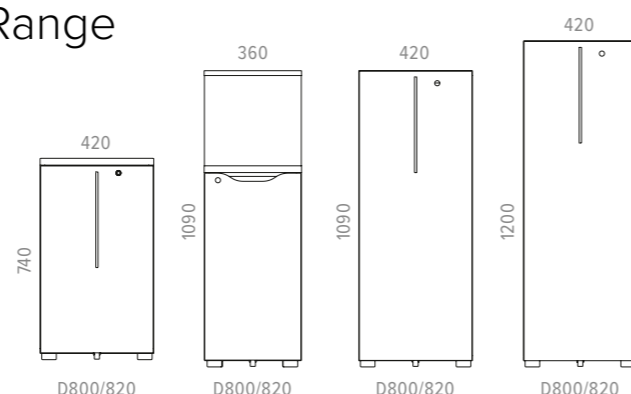

Technical details

Carcass

- 16mm/18mm MFC with 1mm edging
- 25mm MFC with 2mm edging (only H740mm top and H1090mm middle top)

Pull-out drawer

- 18mm MFC with 1mm edging (except W360mm file tower and towers which parts are made of 16mm MFC)
- Soft closing function
- Lockable
- 50kg max. load
- Plastic pen holder integrated in the upper shelf

Inner file drawers

- 12mm MFC with 1mm edging
- Full extension visible ball bearing slides
- W646 x D350 x H280 mm



Inner personal drawers

- 12mm MFC with 1mm edging
- Full extension visible ball bearing slides
- W450 x D300 x H120 mm

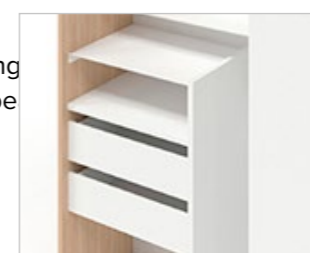

Fixed metal shelves

- 1mm thick powder coated steel sheet
- Fixed with screws

Legs

- Four H23mm plastic height levelling feet (+10 mm)
- Ø80mm castor (non-marking thermoplastic rubber tread)

Sliding doors

- 10mm plywood with laminate, lacquered edges
- No handles (cutouts)
- White plastic slide profile

USB fast charger

- A+C Twin USB Fast Charger integrated into the back panel of the cupboard
- 3m cable
- Dimensions: Ø74 x 50 mm
- Cable standard: UK, EU, CH, FR, US
- Black plastic

Power socket

- AC power socket 100 – 230V
- 3m cable
- Dimensions: Ø74 x 50 mm, hole for socket Ø60mm
- Power socket standards: UK, EU, CH, FR, US
- Black plastic

Hook for clothes

- Dimensions: 20 x 28, H62mm
- Powder coated metal
- Fixed with screws

Materials

Band A MFC

- Whitened Oak (D1)
- Amber Oak (D2)
- White (M1)
- Dark Grey (N1)
- Pearl Grey (N3)

Band B MFC

- Sand Ash (D3)
- Dark Walnut (D4)
- Grey Wood (D5)
- Cubanit Grey (N2)
- Black (J4)

Metal handles (Z)







- Anthracite (T1)
- Black (A)
- Grey (M)
- White (E)





Fabric*

- Era
- Lucia
- Velito Presto
- Synergy



HPL (drawer fronts)

- Grey (H12)
- Cappuccino (H13) Light
- Yellow (H14)
- Mint (H15)
- White (H70)



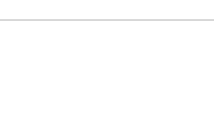

G1: Band A MFC Carcass & Door G2: Band A MFC Carcass + Band B MFC Door		G3: Band B MFC Carcass + Band A MFC Door G4: Band B MFC Carcass & Door							
	CODE	DESCRIPTION	WIDTH	DEPTH	HEIGHT	G1 (£)	G2 (£)	G3 (£)	G4 (£)
	TBR201	R/H tower with 2 shelves and pencil tray	420	800	740	1,031	1,036	1,058	1,075
	TBR202		420	820	740	1,047	1,062	1,079	1,096
	TBL201	L/H tower with 2 shelves and pencil tray	420	800	740	1,031	1,036	1,058	1,075
	TBL202		420	820	740	1,047	1,062	1,079	1,096
	TBR301	R/H tower with bookcase on top No handles (cut-outs)	360	800	1090	1,028	1,050	1,081	1,098
	TBR302		360	820	1090	1,048	1,075	1,097	1,129
	TBL301	L/H tower with bookcase on top No handles (cut-outs)	360	800	1090	1,028	1,050	1,081	1,098
	TBL302		360	820	1090	1,048	1,075	1,097	1,129
	TBU301	Tower with 3 shelves	420	800	1090	1,417	1,454	1,551	1,594
	TBU302		420	820	1090	1,419	1,463	1,559	1,596
	TBR307	R/H tower with 3 shelves and pencil tray	420	800	1200	1,469	1,513	1,609	1,648
	TBR308		420	820	1200	1,481	1,524	1,617	1,656
	TBL307	L/H tower with 3 shelves and pencil tray	420	800	1200	1,473	1,516	1,612	1,651
	TBL308		420	820	1200	1,481	1,524	1,617	1,656

	CODE	DESCRIPTION	WIDTH	DEPTH	HEIGHT	G1 (£)	G2 (£)	G3 (£)	G4 (£)
	TBR309	R/H tower with 2 shelves, 1 metal shelf and file drawer	420	800	1200	1,688	1,705	1,737	1,754
	TBR310		420	820	1200	1,697	1,718	1,745	1,772
	TBL309	L/H tower with 2 shelves, 1 metal shelf and file drawer	420	800	1200	1,688	1,705	1,737	1,754
	TBL310		420	820	1200	1,697	1,718	1,745	1,772
	TBR311	R/H tower with 1 shelf, 2 metal shelves and 2 small drawers	420	800	1200	1,640	1,656	1,699	1,714
	TBR312		420	820	1200	1,656	1,682	1,714	1,736
	TBL311	L/H tower with 1 shelf, 2 metal shelves and 2 small drawers	420	800	1200	1,645	1,661	1,705	1,722
	TBL312		420	820	1200	1,656	1,682	1,714	1,736
	TBR315	R/H tower with power socket, 1 shelf, 2 metal shelves and 2 small drawers	420	800	1200	1,843	1,849	1,887	1,908
	TBR316		420	820	1200	1,868	1,885	1,921	1,938
	TBL315	L/H tower with power socket, 1 shelf, 2 metal shelves and 2 small drawers	420	800	1200	1,843	1,849	1,887	1,908
	TBL316		420	820	1200	1,868	1,885	1,921	1,938
	TBR313	R/H tower with USB A+C Fast Charge, 1 shelf, 2 metal shelves and 2 small drawers	420	800	1200	2,097	2,113	2,140	2,150
	TBR314		420	820	1200	2,119	2,128	2,145	2,167
	TBL313	L/H tower with USB A+C Fast Charge, 1 shelf, 2 metal shelves and 2 small drawers	420	800	1200	2,097	2,113	2,140	2,150
	TBL314		420	820	1200	2,119	2,128	2,145	2,167

G1: Band A MFC Carcass G2: Band B MFC Carcass







	CODE	DESCRIPTION	WIDTH	DEPTH	HEIGHT	G1 (£)	G2 (£)
	TBE081	Bookcase for D800mm towers <i>Not suitable for W360mm towers</i>	800	420	370	144	166
	TBE082	Bookcase for D820mm towers <i>Not suitable for W360mm towers</i>	820	420	370	161	177
	TBE083	Planter box for D800mm towers <i>Not suitable for W360mm towers</i>	800	420	334	106	127
	TBE084	Planter box for D820mm towers <i>Not suitable for W360mm towers</i>	820	420	334	122	160

G1: Band A MFC Carcass + HPL Sliding Door
G2: Band B MFC Carcass + HPL Sliding Door

	CODE	DESCRIPTION	WIDTH	DEPTH	HEIGHT	G1 (£)	G2 (£)
	TBR303	R/H tower with HPL sliding door cupboard on top No handles	360	800	1090	1,164	1,234
	TBR304	R/H tower with HPL sliding door cupboard on top No handles	360	820	1090	1,178	1,254
	TBL303	L/H tower with HPL sliding door cupboard on top No handles	360	800	1090	1,164	1,234
	TBL304	L/H tower with HPL sliding door cupboard on top No handles	360	820	1090	1,178	1,254

G1: Era / Lucia
G2: Velito Presto / Synergy

	CODE	DESCRIPTION	WIDTH	DEPTH	HEIGHT	G1 (£)	G2 (£)
	TBZ001	Felt-lined insert for metal shelves	671	198	3	24	46
	TBZ002	Felt-lined insert for metal shelves	453	342	3	36	52

	CODE	DESCRIPTION	WIDTH	DEPTH	HEIGHT	RSP (£)
	COZ062	Metal shelf (right)	300	300	100	70
	COZ063	Metal shelf (central)	300	300	100	86
	ZTZ005	3 drawer insert with HPL drawer fronts (White MFC carcass only)	370	305	330	355
	ZZZ061	Metal hook for clothes	20	28	62	23
	ZZZ058	Master key (1 pc.)	-	-	-	41
	ZZZ059	Removal key (1 pc.)	-	-	-	24
	ZZZ060	Cylinder lock with 2 keys	-	-	-	26

Uni & Uni Plus

Storage system



A choice of over 60 cupboard and bookcase combinations.

All storage units have 19mm carcasses and 25mm tops to complement desking and finished backs for use as room dividers. Cupboards include shelves and locks. All units are supplied without a base, this must be chosen from the options available.

A universal storage system created for easy document archiving, this exclusively wide range of cupboards allows you to choose from shelves of different heights and widths, paired with different types of possible cupboard doors. Backs of the cupboards may be covered with a whiteboard or with fabric for sound absorption.

You can choose conventional shelves, shelves with dividers and fixed or pull-out filing cradles. All accessories are suitable for UK and EU standards.

Range

Uni

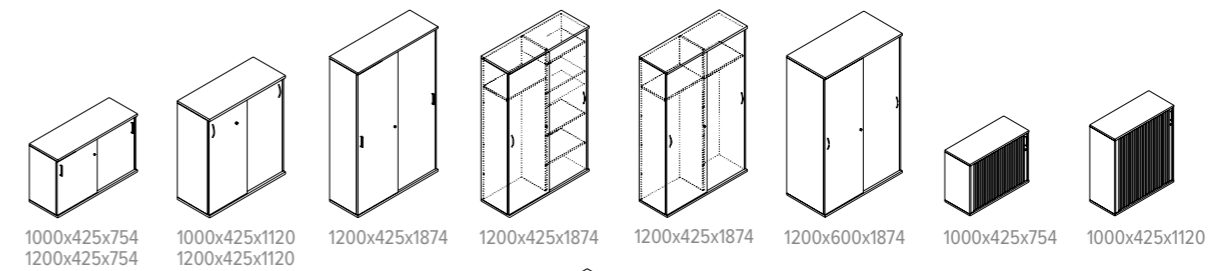
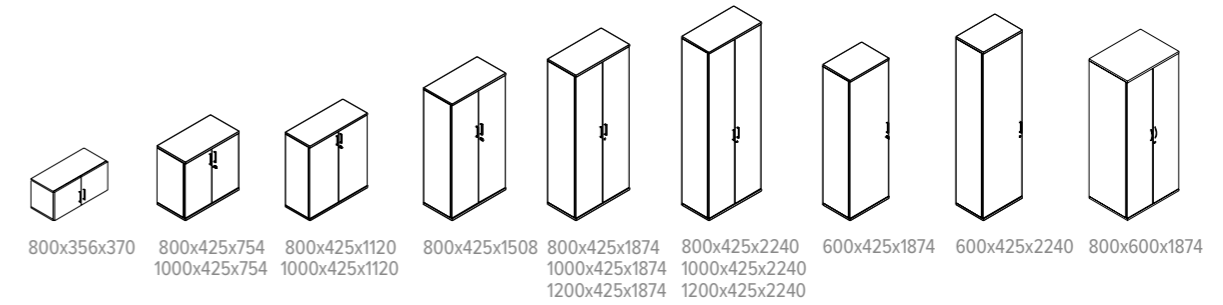
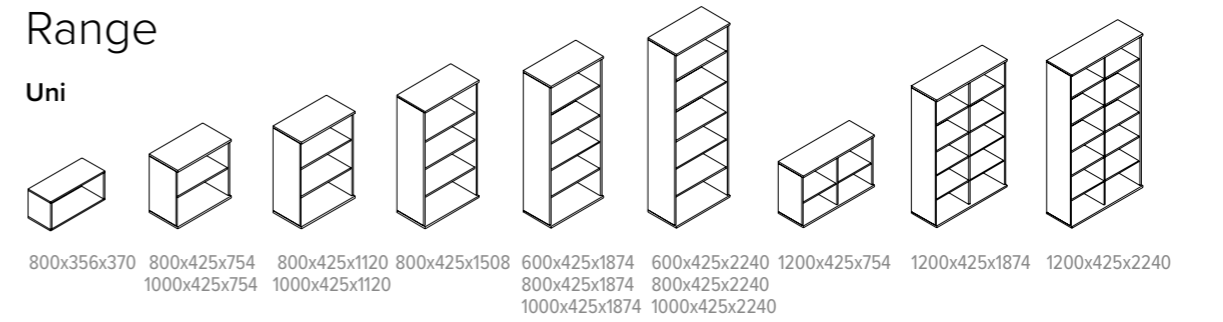

Sliding door

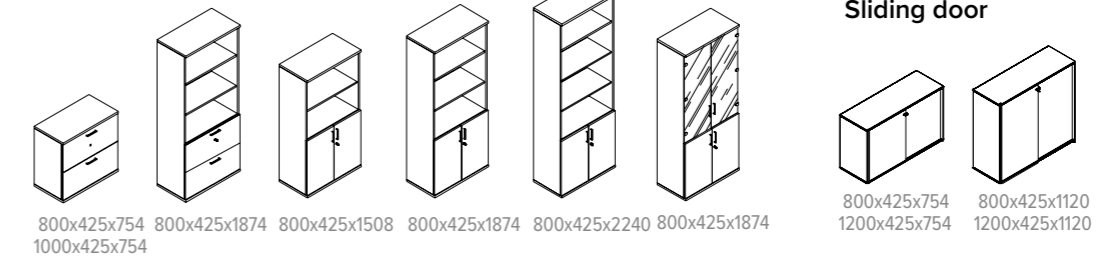

Uni Plus

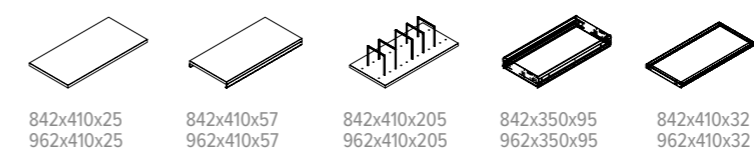
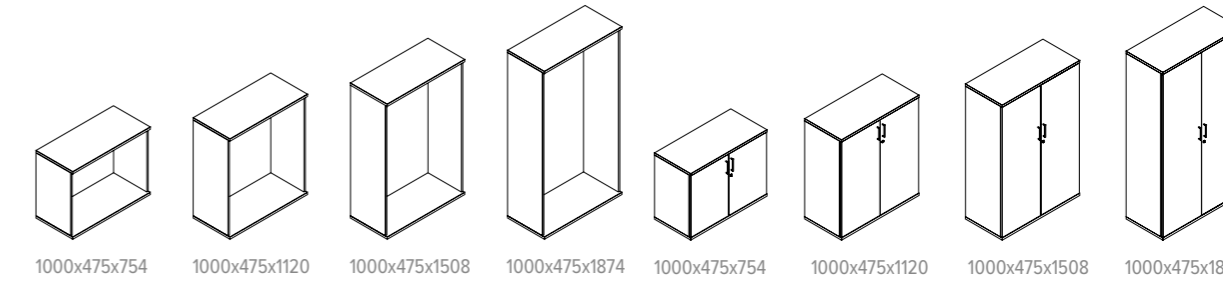
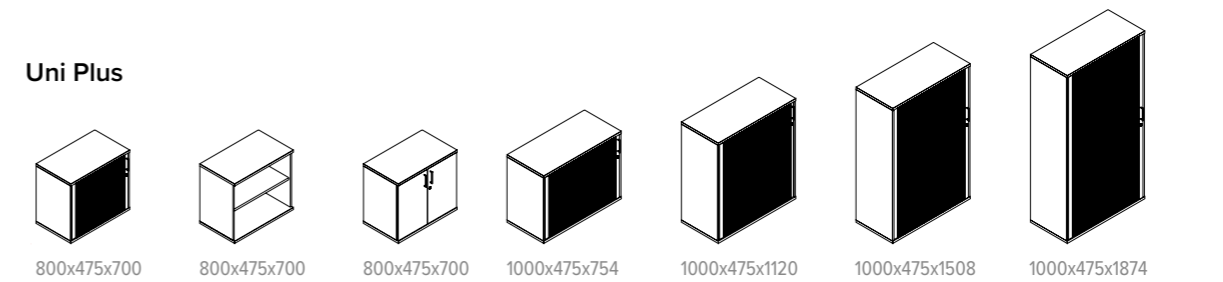

Technical details

Carcass

- 18mm MFC with 1mm ABS edging

Top and bottom

- 25mm MFC with 2mm ABS edging

Back

- Made of 16mm MFC
- Fabric back panel (X0Z071, X0Z103) HDF 3mm coated with 3mm foam and fabric
- HPL 1mm whiteboard back panel (X0Z070, X0Z102)

Shelves

- 18mm MFC with 1mm ABS edging, 25kg load capacity
- 25mm MFC with 2mm ABS edging (for W1000mm carcass), 32kg load capacity
- Fixed or height adjustable shelves

Shelf options

- Metal lateral filing shelf and cradle (suitable for A4 or foolscap)
- Shelf with 5 chromed dividers from metal 5mm

Pull-out filing cradle

- File drawers for both A4 and foolscap files
- Full extension, with anti-tilt function
- Black powder coated welded metal sheet, no bottom
- Ball bearing slide, load capacity 50kg

Doors

- All doors are lockable
- Doors with hinges in 18mm MFC with 1mm ABS edging
- Sliding doors in 18mm MFC with 1mm ABS edging (with plastic runners)
- Tambour doors from ABS profile
- 5mm tempered clear glass

Handles (3 types)

- W136mm square powder coated metal handle (X)
- W150mm curved powder coated metal handle (K)
- Metal profile 60mm powder coated metal handle for sliding door cupboards only (X2S082, X3S082, X2S122, X3S12), length matches door height (Y)

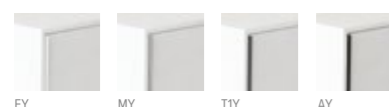

Sliding door handles

- Powder coated metal profile 60mm, length matches the door height

Drawers

- File drawers for both A4 and foolscap files
- Full extension, central locking with anti-tilt function
- Powder coated black welded metal sheet, no bottom
- Ball bearing slide, 50kg load capacity

Fittings

- Cams with connecting bolts
- Lock with metal bars
- Fast assembling hinges (no tools required to connect hinges and plates)

Plinth

- 18mm MFC
- Plastic feet with height levelling (+10 mm)

Metal legs

- 40x40mm powder coated metal tube
- H80mm +10 mm plastic feet with height levelling

Plastic feet

- H23 mm +10mm black plastic height levelling feet, (with OPTIMA desks H720mm)
- H38 mm +10mm black plastic height levelling feet, (with NOVA desks H740mm)

Castors

- 4 x Ø80mm twin wheel castors
- 2 out of 4 with stopper brakes
- 100kg per castor load capacity

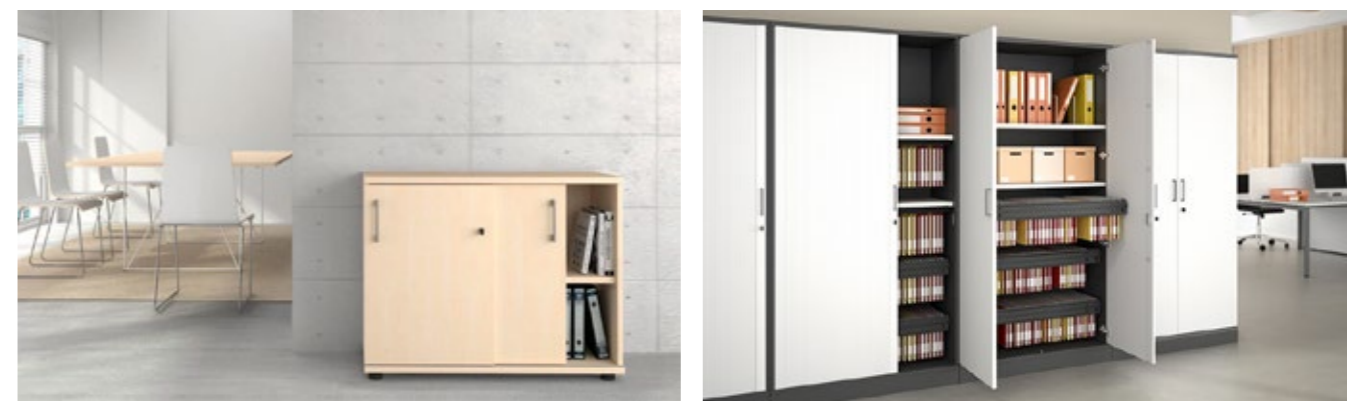

Materials

Band A MFC

Whitened Oak (D1)
Amber Oak (D2)
White (M1)
Dark Grey (N1)
Pearl Grey (N3)

Band B MFC

Sand Ash (D3)
Dark Walnut (D4)
Grey Wood (D5)
Cubanit Grey (N2)
Black (J4)

Glass

Clear (1)
Dark Grey (2)

Metal









Anthracite (T1)
Black (A)
Grey (M)
White (E)









Tambour door







White (E)
Grey (M)















Fabric*

Berta
Bondai
Lucia
Velito Presto
Synergy



G1: Band A MFC Carcass & Doors		G3: Band B MFC Carcass + Band A MFC Doors							
G2: Band A MFC Carcass + Band B MFC Doors		G4: Band B MFC Carcass & Doors							
	CODE	DESCRIPTION	WIDTH	DEPTH	HEIGHT	G1 (£)	G2 (£)	G3 (£)	G4 (£)
	X2C081	Uni cupboard with lockable doors, 2 levels	800	425	754	364	379	396	415
	X2C101		1000	425	754	422	444	444	470
	X3C081	Uni cupboard with lockable doors, 3 levels	800	425	1120	476	505	511	542
	X3C101		1000	425	1120	552	583	603	638
	X4C081	Uni cupboard with lockable doors, 4 levels	800	425	1508	584	640	624	683
	X5C081	Uni cupboard with lockable doors, 5 levels	800	425	1874	685	715	731	762
	X5C101		1000	425	1874	816	856	872	913
	X5C121		1200	425	1874	951	1,003	1,034	1,084
	X5C083	Uni cupboard with lockable doors, metal pull-out hanging rail, 5 levels	800	425	1874	635	666	671	702
	X5C082	Uni cupboard with lockable doors, metal hanging rail, 5 levels	800	600	1874	769	800	831	862
	X5C061	Uni L/H cupboard with lockable door, 5 levels	600	425	1874	563	590	605	624
	X5C063	Uni L/H cupboard with metal pull-out hanging rail, 5 levels	600	425	1874	528	554	563	590
	X5C062	Uni R/H cupboard with lockable door, 5 levels	600	425	1874	563	590	605	624
	X5C064	Uni R/H cupboard with metal pull-out hanging rail, 5 levels	600	425	1874	528	554	563	590

	CODE	DESCRIPTION	WIDTH	DEPTH	HEIGHT	G1 (£)	G2 (£)	G3 (£)	G4 (£)
	X5C122	Uni wardrobe with metal pull-out hanging rail (left side) and shelves (right side)	1200	425	1874	935	987	1,014	1,064
	X5C123	Uni wardrobe with 2 metal pull-out hanging rails	1200	425	1874	928	973	999	1,045
	X6C081	Uni cupboard with lockable doors, 6 levels	800	425	2240	841	892	892	949
	X6C101		1000	425	2240	978	1,019	1,045	1,080
	X6C121		1200	425	2240	1,114	1,170	1,201	1,262
	X6C061	Uni L/H cupboard, lockable door, 6 levels	600	425	2240	734	756	785	805
	X6C062	Uni R/H cupboard, lockable door, 6 levels	600	425	2240	733	753	783	804
	U2C080	Uni Plus cupboard with lockable doors and 1 adj. shelf	800	475	700	380	380	411	416
	U2C100	Uni Plus cupboard with lock, 2 levels*	1000	475	754	390	416	411	432
	U3C100	Uni Plus cupboard with lock, 3 levels*	1000	475	1120	477	512	502	532
	U4C100	Uni Plus cupboard with lock, 4 levels*	1000	475	1508	581	616	612	647
	U5C100	Uni Plus cupboard with lock, 5 levels*	1000	475	1874	678	720	725	766

G1: Band A MFC Carcass & Doors		G3: Band B MFC Carcass + Band A MFC Doors							
G2: Band A MFC Carcass + Band B MFC Doors		G4: Band B MFC Carcass & Doors							
	CODE	DESCRIPTION	WIDTH	DEPTH	HEIGHT	G1 (£)	G2 (£)	G3 (£)	G4 (£)
	X5H061	Uni L/H cupboard with low hinged doors, 5 levels	600	425	1874	490	510	531	552
	X5H062	Uni R/H cupboard with low hinged doors, 5 levels	600	425	1874	488	509	529	550
	X4H081	Uni cupboard with low double doors, 4 levels	800	425	1508	536	556	586	602
	X5H081	Uni cupboard with low double doors, 5 levels	800	425	1874	566	586	603	623
	X6H081	Uni cupboard with low double doors, 6 levels	800	425	2240	638	658	694	710
	X5F081	Uni cupboard with 2 sidefile drawers, 5 levels	800	425	1874	1,259	1,263	1,305	1,305
	X5G081	Uni cupboard with glass upper doors and low double doors, 5 levels	800	425	1874	986	1,007	1,027	1,044

	CODE	DESCRIPTION	WIDTH	DEPTH	HEIGHT	G1 (£)	G2 (£)	G3 (£)	G4 (£)
	X1C081	Uni wall mounted cupboard with doors	800	356	370	195	205	200	215
	X2F081	Uni side filer, 2 drawers for both A4 and foolscap files	800	425	754	1,156	1,181	1,233	1,273
	X2F101	Uni side filer, 2 drawers for both A4 and foolscap files	1000	425	754	1,310	1,335	1,387	1,438
	X2S082	Uni Slide cupboard with sliding doors	800	425	754	487	528	528	563
	X2S122		1200	425	754	581	616	621	664
	X3S082	Uni Slide cupboard with sliding doors	800	425	1120	617	669	659	710
	X3S122		1200	425	1120	734	790	796	848
	X2S101	Uni cupboard with sliding lockable doors, 2 levels	1000	425	754	467	488	508	529
	X2S121		1200	425	754	487	507	528	548
	X3S101	Uni cupboard with sliding lockable doors, 3 levels	1000	425	1120	569	595	615	641
	X3S121		1200	425	1120	581	605	627	653
	X5S121	Uni cupboard with sliding lockable doors, 5 double levels	1200	425	1874	872	903	928	964
	X5S122	Uni wardrobe with sliding doors, metal pull-out hanging rail (left side) and shelves (right side)	1200	425	1874	851	881	913	944
	X5S123	Uni wardrobe with sliding doors, 2 metal pull-out hanging rails	1200	425	1874	837	868	892	923
	X5S124		1200	600	1874	974	1,005	1,073	1,103





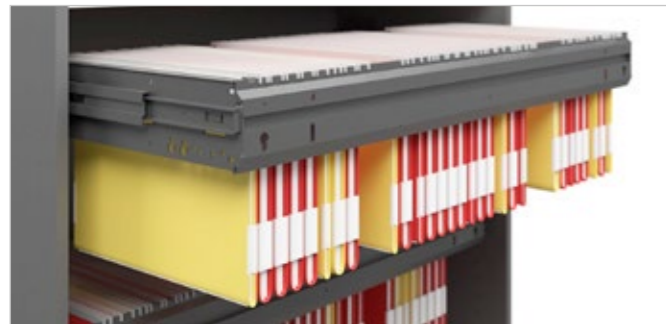



G1: Berta / Bondai
G2: Lucia
G3: Velito Presto / Synergy









	CODE	DESCRIPTION	WIDTH	DEPTH	HEIGHT	G1 (£)	G2 (£)	G3 (£)
	X0Z071	Fabric panel for use with X2N101, X2C101, X2F101, X2T101, X2S101, U2T101, U2N100, U2C100	961	-	703	102	134	205
	X0Z103	Fabric panel for use with X3S101, X3T101, X3C101, U3T101, U3N100, U3C100	961	-	1069	152	172	274

















G1: Band A MFC









G2: Band B MFC





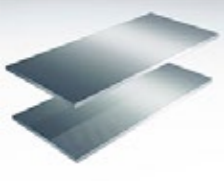

	CODE	DESCRIPTION	WIDTH	DEPTH	HEIGHT	G1 (£)	G2 (£)
	X1N081	Uni wall mounted bookcase, 1 level	800	336	370	160	164
	X2N081	Uni bookcase, 2 levels	800	425	754	214	245
	X2N101		1000	425	754	257	280
	X3N081	Uni bookcase, 3 levels	800	425	1120	288	324
	X3N101		1000	425	1120	348	399
	X4N081	Uni bookcase, 4 levels	800	425	1508	355	396
	X5N061	Uni bookcase, 5 levels	600	425	1874	366	401
	X5N081		800	425	1874	407	452
	X5N101		1000	425	1874	503	560
	X6N061	Uni bookcase, 6 levels	600	425	2240	470	520
	X6N081		800	425	2240	488	540
	X6N101		1000	425	2240	624	687
	X2N121	Uni shelf unit, 2 levels, 1 divider	1200	425	754	323	363
	X5N121	Uni bookcase, 5 levels, 1 divider	1200	425	1874	592	674
	X6N121	Uni bookcase, 6 levels, 1 divider	1200	425	2240	704	790

	CODE	DESCRIPTION	G1: Band A MFC		G2: Band B MFC		
			WIDTH	DEPTH	HEIGHT	G1 (£)	G2 (£)
	U2N080	Uni Plus bookcase with 1 adjustable shelf	800	475	700	237	268
	U0Z020	820mm top for U2C080/U2N080/U2T080 when used on end of D1640mm Nova bench desks	820	475	25	58	62
	U2T080	Uni Plus cupboard with tambour lock doors and adj. shelf	800	475	700	569	591
	X2T101	Uni cupboard with tambour doors, 2 levels	1000	425	754	657	693
	U2T101	Uni Plus cupboard with tambour doors, 2 levels*	1000	475	754	627	673
	X3T101	Uni cupboard with tambour doors, 3 levels	1000	425	1120	899	966
	U3T101	Uni Plus cupboard with tambour doors, 3 levels*	1000	475	1120	829	886
	U4T101	Uni Plus cupboard with tambour doors and lock*	1000	475	1508	1,131	1,187
	U5T101	Uni Plus cupboard with tambour doors and lock*	1000	475	1874	1,178	1,238

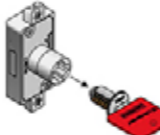
	CODE	DESCRIPTION	WIDTH	DEPTH	HEIGHT	G1 (£)	G2 (£)
	U2N100	Uni Plus bookcase, 2 levels*	1000	475	754	227	247
	U3N100	Uni Plus bookcase, 3 levels*	1000	475	1120	273	298
	U4N100	Uni Plus bookcase, 4 levels*	1000	475	1508	324	349
	U5N100	Uni Plus bookcase, 5 levels*	1000	475	1874	366	412
	U0Z001	Adjustable shelf for Uni Plus tambour door cupboard	842	410	25	46	50
	U0Z002	2 adjustable shelves for Uni Plus tambour door cupboards	842	410	25	72	78
	U0Z010	Adjustable shelf for Uni Plus bookcases & double door cupboards	962	410	25	51	58
	U0Z011	2 adjustable shelves for Uni Plus bookcases & double door cupboards	962	410	25	95	106
	U0Z012	Fixed shelf for Uni Plus tambour door cupboards - 1 must be ordered per 4 or 5 level unit	844	410	25	50	56
	U0Z013	Fixed shelf for Uni Plus bookcases & double door cupboards - 1 must be ordered per 4 or 5 level unit	962	410	25	58	62
	U0Z003	Lateral filing shelf for Uni Plus tambour door cupboards	842	410	25	140	144
	U0Z014	Lateral filing shelf for Uni Plus bookcases & double door cupboards	962	410	25	144	151
	U0Z008	Shelf with 5 chrome dividers for Uni Plus tambour door cupboards	842	410	25	88	92
	U0Z015	Shelf with 5 chrome dividers for Uni Plus bookcases & double door cupboards	942	410	25	99	103

	CODE	DESCRIPTION	G1: Band A MFC			G2: Band B MFC	
			WIDTH	DEPTH	HEIGHT	G1 (£)	G2 (£)
	X0Z060	Plinth for 600mm x 425mm storage	-	-	80	41	46
	X0Z080	Plinth for 800mm x 425mm storage	-	-	80	46	50
	X0Z081	Plinth for 800mm x 600mm storage	-	-	80	47	51
	X0Z100	Plinth for 1000mm x 425mm storage	-	-	80	51	58
	X0Z101	Plinth for 1000mm x 475mm Uni Plus storage	-	-	80	60	65
	X0Z120	Plinth for 1200mm x 425mm storage	-	-	80	59	64
	X0Z121	Plinth for 1200mm x 600mm storage	-	-	80	65	69

	CODE	DESCRIPTION	WIDTH	DEPTH	HEIGHT	RSP (£)
	X0Z004	4 metal legs for W600/W800/W1000mm storage	-	-	80	46
	X0Z005	4 metal legs and 1 support leg for W1200mm storage	-	-	80	50
	X0Z013	4 plastic feet for W600/W800/W1000mm storage	-	-	20	17
	X0Z014	5 plastic feet for W1200mm storage	-	-	20	17
	X0Z015	Plastic feet for W600/W800/W1000mm Uni Plus storage	-	-	38	33
	X0Z006	4 castors (2 with brakes) for W800mm storage, up to 3 levels	-	-	90	133
	X0Z007	5 castors (2 with brakes) for W1000-1600mm storage, up to 3 levels	-	-	90	153
	X0Z008	Metal counterweight for storage with metal legs or plastic feet (X5C063, X5C064, X5F081)	-	-	-	233
	X0Z009	Metal counterweight for storage with metal legs or plastic feet (X5C122, X5C123)	-	-	-	282
	X0Z010	Counterweight for X5C063, X5C064, X5C122, X5C123 with plinth	-	-	-	87
	X0Z011	Counterweight for X5F081 with plinth	-	-	-	116

	CODE	DESCRIPTION	WIDTH	DEPTH	HEIGHT	RSP (£)
	ZZZ058	Master key (1 pc.)	-	-	-	41
	ZZZ059	Barrel removal key (1 pc.)	-	-	-	24
	X0Z070	Whiteboard panel for use with: X2N101, X2C101, X2F101, X2T101, X2S101, U2T101, U2N100, U2C100	961	-	703	141
	X0Z102	Whiteboard panel for use with: X3S101, X3T101, X3C101, U3T101, U3N100, U3C100	961	-	1069	196
	U0Z004	Pull-out black metal filing cradle (suitable for A4 or foolscap filing) for Uni Plus cupboards with tambour doors	842	350	95	264
	U0Z016	Pull-out black metal filing cradle (suitable for A4 or foolscap filing) for Uni Plus W1000 cupboards	962	350	95	282
	G6F116	Anti-tilt mechanism (1 required per extra pull-out cradle)	-	-	-	31
	U0Z007	Filing cradle for D475mm Uni Plus tambour door cupboards	842	410	25	86
	U0Z019	Filing cradle for D475mm Uni Plus bookcases & double door cupboards	962	410	25	96

Choice

Storage system



A modular storage system for modern workspaces.

Endless choices of sizes, door types, shelf options, bases and more make the Choice storage range stand out from the crowd. Choice storage units can be easily combined into multiple arrangements, allowing flexible storage solutions for any area of your workspace.

You can also combine different textures: fabric, melamine and natural veneer. Choose from a wide range of fabrics to create desired colour combinations that will blend nicely into your office.

You can use acoustic doors along with other acoustic solutions (panels, partitions) to create a better acoustic comfort in your office.

Metal baseboard or metal legs will be perfect for those who want to create a minimalist office style. Legs made of natural ash wood will bring you closer to nature in a very subtle manner. Castors will make it easy to rearrange office furniture.

Range

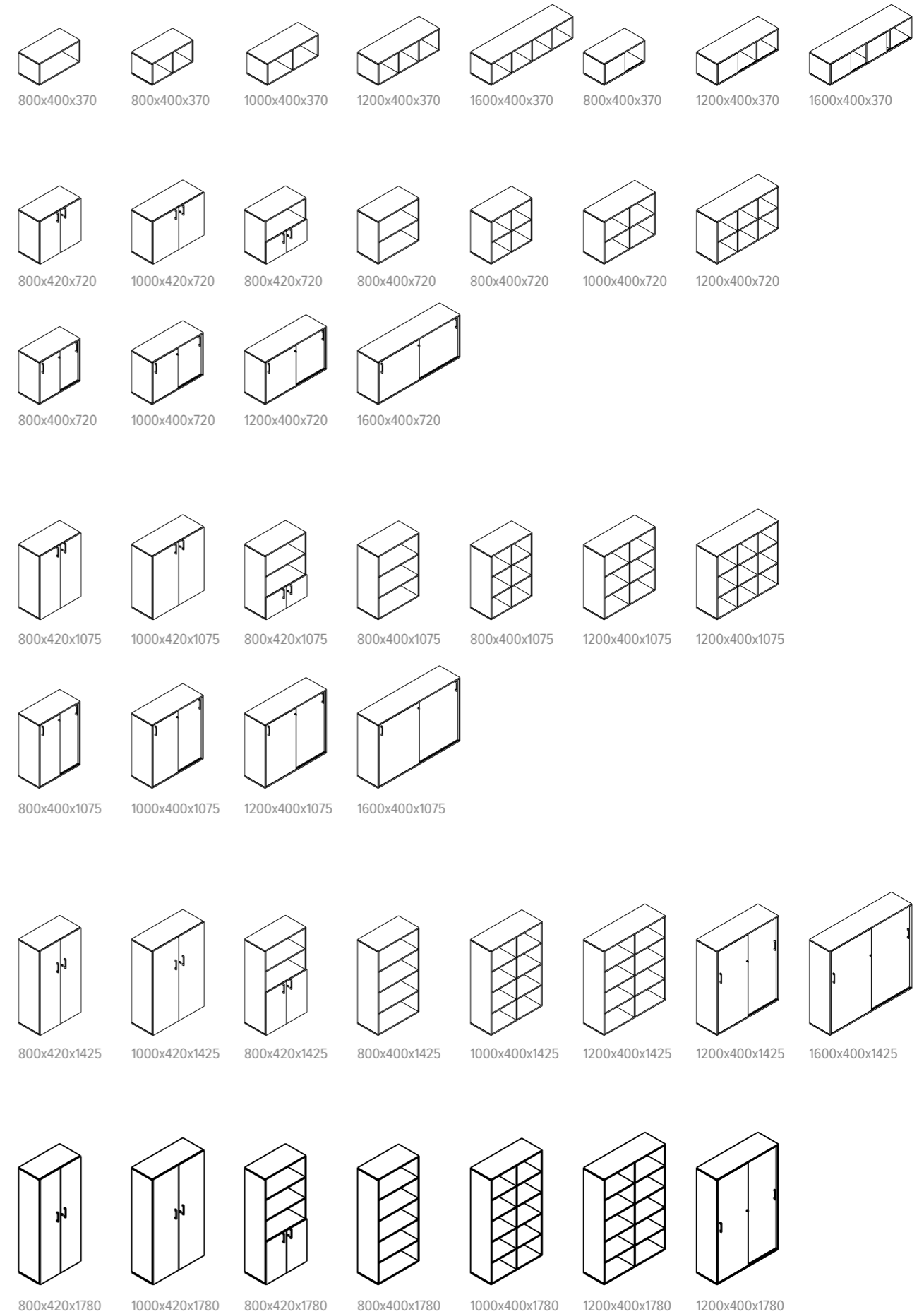

Technical details

Carcass

- 18mm MFC with 1mm ABS edging

Top and bottom

- 18mm MFC with 1mm ABS edging

Back

- Made of 18mm MFC

Shelves

- 18mm MFC with 1mm ABS edging, 25kg load capacity
- 25mm MFC with 2mm ABS edging, 32kg load capacity (for W1000mm carcass)
- 28mm metal sheet, 40kg load capacity
- Fixed or height adjustable shelves

Doors (with lock)

- Doors with hinges in 18mm MFC with 1mm ABS edging
- Sliding doors in 18mm MFC with 1mm ABS edging (with plastic runners).

Acoustic doors (with lock)

- Acoustic chipboard, MFC faced surface with 2mm ABS edging
- Absorption class: C
- Weighted sound absorption coefficient: $\alpha_w = 0.75$ (MH)
- SAA (Sound Absorption Average): 0.83
- NRC (Noise Reduction Coefficient): 0.85

Handles (2 types)

- Powder coated metal handles (EG, MG, AG, T1G, EX, MX, AX, T1X), 128mm fixing hole



- recessed powder coated aluminium handles 145 x 42 x 15 mm (EC, MC, AC, T1C)

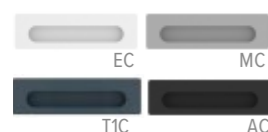

Fittings

- Cams with connecting bolts
- Lock without metal bars
- Fast assembling hinges (no tools required to connect hinges to plates)
- Soft closing hinges
- Sliding doors with plastic runners
- Wardrobe with metal pull-out hanging rail (D420mm cupboards)

Bases

- 18mm MFC plinth, H80mm +10mm height levelling
- Welded metal tube plinth, H40mm +10mm height levelling

H80mm metal legs

- Powder coated metal tube - 20x20 mm;
- H80mm Plastic legs +10mm height levelling

H150mm metal legs with frame

- 20x20 mm powder coated welded metal tube
- H150mm plastic legs +10 mm height levelling

Plastic feet

- H17mm black plastic height levelling legs +10 mm

H150 mm solid wood legs

- Lacquered natural ash solid wood base +10mm height levelling

Castors

- Four Ø80mm twin wheel castors
- Two out of four with stopper brakes
- 100kg per castor load capacity

Shelves for letters (post shelf)

- 16mm MFC with 1mm ABS edging

Shelf/Shelf with dividers

- 18 / 25 mm MFC with 1mm ABS edging
- 7 chromed metal dividers (only for shelves with dividers)

Drawers for foolscap

- File drawers for both A4 and foolscap files
- Full extension with anti-tilt function
- Powder coated black welded metal sheet, without bottom
- Ball bearing slide, 50kg load capacity

Pencil tray (stationery drawer)

- W380 x H32 mm black plastic tray with 375mm mounting brackets
- Ball bearing slide full extension
- Mounted under cupboard top, or shelves
- 2kg load capacity (EN 15338)

Wire frame for foolscap / A4 (frame-mounted binders)

- W340 x D305 x H245 mm galvanized wire with black plastic corners

Cushion

- 3 different sizes: 790 x 390 x 32, 990 x 390 x 32, 1190 x 390 x 32 mm
- Cushions are for 1H and 2H cupboards - fixed on the top of the cupboard with velcro tape
- Two cushions (790) are needed for W1600mm cupboards
- HR5050 foam rubber is used in cushion production

Fabric back panel

- HDF 3mm coated with 3mm foam and fabric (fixed with glue stickers)

Side and top panels

- 16mm MFC with 1mm ABS edging
- 16mm chipboard, covered in wood veneer with 1.5mm edging

Stickers

- Adhesive stickers (H0.13mm) for placing one cupboard on the top of another without fixings

Counterweight

- 8mm powder coated metal plate (Grey only), fixed with screws underneath
- 25mm MFC with two 0.5mm ABS edges, fixed with stickers to the back panel inside the cupboard

Materials

Band A MFC

- Whitened Oak (D1)
- Amber Oak (D2)
- White (M1)
- Dark Grey (N1)
- Pearl Grey (N3)

Band B MFC

- Sand Ash (D3)
- Dark Walnut (D4)
- Grey Wood (D5)
- Cubanit Grey (N2)
- Black (J4)

Metal

- Anthracite (T1)
- Black (A)
- Grey (M)
- White (E)

Veneer

- Oak (AA)
- Maple (KK)
- Walnut (RR)
- Ash (V1)

Fabric*

- Berta
- Era
- Bondai
- Step/Step Melange
- Lucia
- Velito Presto
- Synergy



G1: Band A MFC

G2: Band B MFC

	CODE	DESCRIPTION	WIDTH	DEPTH	HEIGHT	G1 (£)	G2 (£)
--	------	-------------	-------	-------	--------	--------	--------



C1N080

Bookcase, 1 level

800 400 370 128 176

G1: Band A MFC Carcass & Shelves
 G2: Band A MFC Carcass + Band B MFC Shelves
 G3: Band B MFC Carcass + Band A MFC Shelves
 G4: Band B MFC Carcass & Shelves

	CODE	DESCRIPTION	WIDTH	DEPTH	HEIGHT	G1 (£)	G2 (£)	G3 (£)	G4 (£)
--	------	-------------	-------	-------	--------	--------	--------	--------	--------



C1N081

Bookcase, 1 level, 1 divider

800 400 370 141 147 189 195

C1N100

1000 400 370 160 172 207 220



C1N120

Bookcase, 1 level, 2 dividers

1200 400 370 206 218 260 278



C1N160

Bookcase, 1 level, 3 dividers

1600 400 370 262 279 340 351



	CODE	DESCRIPTION	WIDTH	DEPTH	HEIGHT	G1 (£)	G2 (£)	G3 (£)	G4 (£)
--	------	-------------	-------	-------	--------	--------	--------	--------	--------



C2N080

Bookcase, 2 levels

800 400 720 241 247 307 319



C2N081

Bookcase, 2 levels, 1 divider

800 400 720 274 285 333 346

C2N100

1000 400 720 308 333 375 393



C2N120

Bookcase, 2 levels, 2 dividers

1200 400 720 378 413 461 496



C3N080

Bookcase, 3 levels

800 400 1075 316 340 404 429



C3N081

Bookcase, 3 levels, 1 divider

800 400 1075 371 406 448 484

C3N100







1000 400 1075 403 446 500 541













C3N120





Bookcase, 3 levels, 2 dividers

1200 400 1075 530 590 637 702

G1: Band A MFC Carcass & Shelves		G3: Band B MFC Carcass + Band A MFC Shelves							
G2: Band A MFC Carcass + Band B MFC Shelves		G4: Band B MFC Carcass & Shelves							
	CODE	DESCRIPTION	WIDTH	DEPTH	HEIGHT	G1 (£)	G2 (£)	G3 (£)	G4 (£)
	C4N080	Bookcase, 4 levels	800	400	1425	419	449	509	539
	C4N100	Bookcase, 4 levels, 1 divider	1000	400	1425	543	597	670	730
	C4N120		1200	400	1425	604	664	735	789
	C5N080	Bookcase, 5 levels	800	400	1780	481	524	613	654
	C5N100	Bookcase, 5 levels, 1 divider	1000	400	1780	675	741	806	867
	C5N120		1200	400	1780	724	808	868	946
	C6N080	Bookcase, 6 levels	800	400	2130	603	650	740	788
	C6N100	Bookcase, 6 levels, 1 divider	1000	400	2130	813	895	962	1,045
	C6N120		1200	400	2130	884	998	1,063	1,178

G1: Band A MFC Carcass & Doors		G3: Band B MFC Carcass + Band A MFC Doors							
G2: Band A MFC Carcass + Band B MFC Doors		G4: Band B MFC Carcass & Doors							
	CODE	DESCRIPTION	WIDTH	DEPTH	HEIGHT	G1 (£)	G2 (£)	G3 (£)	G4 (£)
	C2C080	Cupboard with double locking doors, no shelves	800	420	720	455	467	520	540
	C2C100		1000	420	720	499	523	576	600
	C2C081	Cupboard with double locking doors, 2 levels	800	420	720	500	517	577	595
	C2C101		1000	420	720	557	575	652	669
	C3C080	Cupboard with double locking doors, no shelves	800	420	1075	523	546	600	623
	C3C100		1000	420	1075	574	609	662	698
	C3C081	Cupboard with double locking doors, 3 levels	800	420	1075	592	622	700	724
	C3C101		1000	420	1075	675	711	789	825
G1: Band A MFC Carcass + White MFC Doors		G2: Band B MFC Carcass + White MFC Doors							
	CODE	DESCRIPTION	WIDTH	DEPTH	HEIGHT	G1 (£)	G2 (£)		
	C3C082	Cupboard with double acoustic locking doors, no shelves	800	420	1075	1,771	1,849		
	C3C083	Cupboard with double acoustic locking doors, 3 levels	800	420	1075	1,846	1,947		

		G1: Band A MFC Carcass & Doors				G3: Band B MFC Carcass + Band A MFC Doors			
		G2: Band A MFC Carcass + Band B MFC Doors				G4: Band B MFC Carcass & Doors			
	CODE	DESCRIPTION	WIDTH	DEPTH	HEIGHT	G1 (£)	G2 (£)	G3 (£)	G4 (£)
	C4C080	Cupboard with double locking doors, no shelves	800	420	1425	653	701	742	790
	C4C100		1000	420	1425	709	757	822	863
	C4C081	Cupboard with double locking doors, 4 levels	800	420	1425	751	799	867	914
	C4C101		1000	420	1425	853	902	1,016	1,062
	C5C080	Cupboard with double locking doors, no shelves	800	420	1780	786	839	917	971
	C5C100		1000	420	1780	853	919	985	1,052
	C5C081	Cupboard with double locking doors, 5 levels	800	420	1780	907	960	1,081	1,134
	C5C101		1000	420	1780	1,047	1,107	1,227	1,292
	C6C080	Cupboard with double locking doors, no shelves	800	420	2130	922	987	1,059	1,131
	C6C100		1000	420	2130	1,010	1,088	1,160	1,243





	CODE	DESCRIPTION	WIDTH	DEPTH	HEIGHT	G1 (£)	G2 (£)	G3 (£)	G4 (£)
	C6C081	Cupboard with double locking doors, 6 levels	800	420	2130	1,077	1,143	1,262	1,334
	C6C101		1000	420	2130	1,254	1,332	1,479	1,557
	C4C082	Wardrobe with double locking doors, 1 shelf and metal pull-out hanging rail	800	420	1425	659	694	760	796
	C5C082		800	420	1780	797	851	941	996
	C2H080	Cupboard with double locking doors and open top section, 2 levels	800	420	720	470	475	546	552
	C3H080	Cupboard with double locking doors and open top section, 3 levels	800	420	1075	558	571	660	667
	C4H080	Cupboard with double locking doors and open top section, 4 levels	800	420	1425	676	690	790	808





G1: Band A MFC Carcass & Doors







G2: Band A MFC Carcass + Band B MFC Doors







G3: Band B MFC Carcass + Band A MFC Doors







G4: Band B MFC Carcass & Doors









	CODE	DESCRIPTION	WIDTH	DEPTH	HEIGHT	G1 (£)	G2 (£)	G3 (£)	G4 (£)
	C5H080	Cupboard with double locking doors and open top section, 5 levels	800	420	1780	737	756	916	928
	C6H080	Cupboard with double locking doors and open top section, 6 levels	800	420	2130	853	884	1,045	1,070
	C1S080	Cupboard with 1 sliding locking door, 2 sections	800	400	370	182	189	224	230
	C1S120	Cupboard with 1 sliding locking door, 3 sections	1200	400	370	245	250	309	317
	C1S160	Cupboard with 2 sliding locking doors, 4 sections	1600	400	370	342	347	425	431









	CODE	DESCRIPTION	WIDTH	DEPTH	HEIGHT	G1 (£)	G2 (£)	G3 (£)	G4 (£)
	C2S080	Cupboard with 2 sliding locking doors, 2 levels	800	400	720	464	484	542	560
	C2S100		1000	400	720	507	531	596	620
	C2S120		1200	400	720	550	574	664	683
	C2S160		1600	400	720	660	702	786	827
	C3S080	Cupboard with 2 sliding locking doors, 3 levels	800	400	1075	536	559	650	672
	C3S100		1000	400	1075	621	646	747	771
	C3S120		1200	400	1075	691	732	835	876
	C3S160		1600	400	1075	853	900	1,026	1,079
	C4S120	Cupboard with 2 sliding locking doors, 4 levels	1200	400	1425	867	914	1,056	1,106
	C4S160		1600	400	1425	1,051	1,116	1,260	1,325
	C5S120	Cupboard with 2 sliding locking doors, 5 levels	1200	400	1780	1,018	1,082	1,238	1,297
	C4S121	Wardrobe with sliding locking doors, 1 shelf and metal pull-out hanging rails	1200	400	1425	813	860	980	1,027
	C5S121		1200	400	1780	928	995	1,120	1,180



	G1: Band A MFC			G2: Band B MFC			G3: Veneer		
	CODE	DESCRIPTION	WIDTH	DEPTH	HEIGHT	G1 (£)	G2 (£)	G3 (£)	
	COZ007	Sides and top for 1H, 800mm wide and 370mm height cupboards	835	420	386	80	86	236	
	COZ008	Sides and top for 2H, 800mm wide and 720mm height cupboards	835	420	738	103	126	330	
	COZ009	Sides and top for 3H, 800mm wide and 1075mm height cupboards	835	420	1090	125	156	425	
	COZ010	Sides and top for 4H, 800mm wide and 1425mm height cupboards	835	420	1442	171	213	530	
	COZ011	Sides and top for 5H, 800mm wide and 1780mm height cupboards	835	420	1794	190	231	614	
	COZ012	Sides and top for 1H, 1000mm wide and 370mm height cupboards	1035	420	386	190	214	375	









	CODE	DESCRIPTION	WIDTH	DEPTH	HEIGHT	G1 (£)	G2 (£)	G3 (£)
	COZ013	Sides and top for 2H, 1000mm wide and 720mm height cupboards	1035	420	738	113	132	358
	COZ014	Sides and top for 3H, 1000mm wide and 1075mm height cupboards	1035	420	1090	133	168	449
	COZ015	Sides and top for 4H, 1000mm wide and 1425mm height cupboards	1035	420	1442	178	215	556
	COZ016	Sides and top for 5H, 1000mm wide and 1780mm height cupboards	1035	420	1794	197	245	652
	COZ017	Sides and top for 1H, 1200mm wide and 370mm height cupboards	1235	420	386	110	127	315
	COZ018	Sides and top for 2H, 1200mm wide and 720mm height cupboards	1235	420	738	136	154	406
	COZ019	Sides and top for 3H, 1200mm wide and 1075mm height cupboards	1235	420	1090	141	182	488

	G1: Band A MFC			G2: Band B MFC			G3: Veneer		
	CODE	DESCRIPTION	WIDTH	DEPTH	HEIGHT	G1 (£)	G2 (£)	G3 (£)	
	COZ020	Sides and top for 4H, 1200mm wide and 1425mm height cupboards	1235	420	1442	184	227	580	
	COZ021	Sides and top for 5H, 1200mm wide and 1780mm height cupboards	1235	420	1794	192	246	664	
	COZ022	Sides and top for 1H, 1600mm wide and 370mm height cupboards	1635	420	386	126	144	360	
	COZ023	Sides and top for 2H, 1600mm wide and 720mm height cupboards	1635	420	738	132	172	441	
	COZ024	Sides and top for 3H, 1600mm wide and 1075mm height cupboards	1635	420	1090	169	205	540	
	COZ025	Sides and top for 4H, 1600mm wide and 1425mm height cupboards	1635	420	1442	191	232	628	

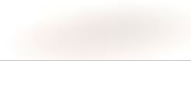
	G1: Era / Bondai			G2: Step/Step Melange / Lucia			G3: Velito Presto / Synergy		
	CODE	DESCRIPTION	WIDTH	DEPTH	HEIGHT	G1 (£)	G2 (£)	G3 (£)	
	COZ087	Hook-and-loop cushion for W900mm wide units	790	390	32	166	202	263	
	COZ107	Hook-and-loop cushion for W1000mm wide units	990	390	32	171	213	271	
	COZ127	Hook-and-loop cushion for 1200mm wide units	1190	390	32	181	224	289	
	G1: Berta / Bondai			G2: Lucia			G3: Velito Presto / Synergy		
	CODE	DESCRIPTION	WIDTH	DEPTH	HEIGHT	G1 (£)	G2 (£)	G3 (£)	
	COZ083	Fabric back panel for 1 level, W800mm x H370mm units	762	-	334	54	67	96	
	COZ084	Fabric back panel for 2 level, W800mm x H720mm units	762	-	684	76	94	141	
	COZ085	Fabric back panel for 3 level, W800mm x H1075mm units	762	-	1038	110	159	243	
	COZ086	Fabric back panel for 4 level, W800mm x H1425mm units	762	-	1389	144	193	276	
	COZ103	Fabric back panel for 1 level, W1000mm x H370mm units	962	-	334	68	72	109	
	COZ104	Fabric back panel for 2 level, W1000mm x H720mm units	962	-	684	116	122	175	
	COZ105	Fabric back panel for 3 level, W1000mm x H1075mm units	962	-	1038	156	204	300	









G1: Berta / Bondai		G2: Lucia		G3: Velito Presto / Synergy				
	CODE	DESCRIPTION	WIDTH	DEPTH	HEIGHT	G1 (£)	G2 (£)	G3 (£)
	COZ106	Fabric back panel for 4 level, W1000mm x H1425mm units	962	-	1389	206	230	331
	COZ123	Fabric back panel for 1 level, W1200mm x H370mm units	1162	-	334	76	94	123
	COZ124	Fabric back panel for 2 level, W1200mm x H720mm units	1162	-	684	120	134	205
	COZ125	Fabric back panel for 3 level, W1200mm x H1075mm units	1162	-	1038	237	284	386
	COZ126	2 fabric back panels (2pcs.) for 4 level, W1200mm x H1425mm units	573	-	1389	223	276	414
	COZ163	Fabric back panel for 1 level, W1600mm x H370mm units	1562	-	334	85	108	156
	COZ164	Fabric back panel for 2 level, W1600mm x H720mm units	1562	-	684	149	179	263
	COZ165	2 fabric back panels (2pcs.) for 3 level, W1600mm x H1075mm units	772	-	1038	255	321	477
	COZ166	2 fabric back panels (2pcs.) for 4 level, W1600mm x H1425mm units	772	-	1389	351	344	511

G1: Era		G2: Lucia		G3: Velito Presto / Synergy				
	CODE	DESCRIPTION	WIDTH	DEPTH	HEIGHT	G1 (£)	G2 (£)	G3 (£)
	DZZ001	Felt-lined metal drawer with lock	584	290	50	312	325	338
	DZZ002	Felt-lined metal drawer with lock	585	250	50	328	341	354

		G1: Band A MFC		G2: Band B MFC			
	CODE	DESCRIPTION	WIDTH	DEPTH	HEIGHT	G1 (£)	G2 (£)
	COZ026	Shelf for 2 level, 800mm wide storage	764	379	18	45	56
	COZ027	2 shelves for 3 level, 800mm wide storage	764	379	18	77	101
	COZ028	2 shelves and 1 fixed shelf for 4 level, 800mm wide storage	764	379	18	100	124
	COZ029	3 shelves and 1 fixed shelf for 5 level, 800mm wide storage	764	379	18	128	171
	COZ030	Shelf for 2 level, 1000mm wide storage	964	379	25	60	77
	COZ031	2 shelves for 3 level, 1000mm wide storage	964	379	25	103	126
	COZ032	2 shelves and 1 fixed shelf for 4 level, 1000mm wide storage	964	379	25	147	195
	COZ033	3 shelves and 1 fixed shelf for 5 level, 1000mm wide storage	964	379	25	189	244
	COZ034	Shelf for 800mm wide storage	764	379	18	50	63
	COZ035	Shelf for 1000mm wide storage	964	379	25	65	77
	COZ036	Shelf with 7 chrome dividers for 800mm storage	764	379	200	120	125
	COZ037	Shelf with 7 chrome dividers for 1000mm storage	964	379	200	127	146
	COZ049	Pigeon hole insert for 800mm wide storage	764	310	334	77	101
	COZ050	Pigeon hole insert for 1000mm wide storage	964	310	327	83	111
	XOZ021	2 MFC counterweights for 800mm wide storage unit with pull out filing cradle	764	333	25	86	110
	XOZ022	2 MFC counterweights for 1000mm wide storage unit with pull out filing cradle	964	333	25	113	124
	COZ080	Wooden plinth for W800mm cupboards	800	400	80	54	67
	COZ100	Wooden plinth for W1000mm cupboards	1000	400	80	62	75
	COZ120	Wooden plinth for W1200mm cupboards	1200	400	80	68	75
	COZ160	Wooden plinth for W1600mm cupboards	1600	400	80	76	94





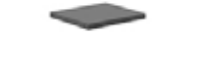
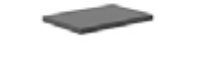







STORAGE CHOICE

narbutas

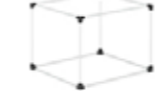
	CODE	DESCRIPTION	WIDTH	DEPTH	HEIGHT	RSP (£)
	COZ081	Metal plinth for W800mm cupboards	800	400	40	81
	COZ101	Metal plinth for W1000mm cupboards	1000	400	40	90
	COZ121	Metal plinth for W1200mm cupboards	1200	400	40	111
	COZ161	Metal plinth for W1600mm cupboards	1600	400	40	124
	COZ001	5 plastic feet for W800/1000mm storage	Ø50	-	17	21
	COZ002	6 plastic feet for W1200/1600mm storage	Ø50	-	17	21
	COZ003	Metal legs for W800/1000mm storage	400	153	80	31
	COZ004	Metal legs for W1200/1600mm storage	400	153	80	44
	COZ082	Metal frame with legs	800	400	150	102
	COZ102		1000	400	150	123
	COZ122	Metal frame with legs and central leg	1200	400	150	135
	COZ162		1600	400	150	161
	COZ005	4 stained natural ash (W2) or ash stained black (W3) solid wooden legs for 800/1000mm wide storage	400	160	150	382
	COZ006	5 stained natural ash (W2) or ash stained black (W3) solid wooden legs for 1200/1600mm wide storage	400	160	150	431
	XOZ006	4 castors (2 with brakes) for 800mm wide storage	N/A	N/A	90	137
	XOZ007	5 castors (2 with brakes) for 1000-1600 mm wide storage	N/A	N/A	90	159
	COZ052	Black plastic drawer (without lock)	380	375	32	150
	COZ038	Metal lateral filing shelf for 800mm wide storage with hinged doors (suitable for A4 suspension files)	764	378	28	102
	COZ039	Metal lateral filing shelf for 1000mm wide storage with hinged doors (suitable for A4 suspension files)	964	378	28	116
	COZ040	Metal shelf for 800mm wide storage with sliding doors	373	326	28	65
	COZ041	Metal shelf for 1000mm wide storage with sliding doors	473	326	28	71

narbutas

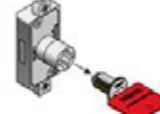
CHOICE STORAGE

	CODE	DESCRIPTION	WIDTH	DEPTH	HEIGHT	RSP (£)
	COZ042	Metal shelf for 1200mm wide storage with sliding doors	573	326	28	75
	COZ043	Metal shelf for 1600mm wide storage with sliding doors	773	326	28	94
	COZ044	Pull-out filing cradle for 800mm wide storage - max. 1 per unit	762	350	95	335
	COZ045	Pull-out filing cradle for 1000mm wide storage - max. 1 per unit	962	350	95	359
	COZ046	Pull-out black metal filing cradle and anti tilt for 800mm wide storage, black, 2 pcs.	762	350	95	692
	COZ047	Pull-out black metal filing cradle and anti tilt for 1000mm wide storage, black, 2 pcs.	962	350	95	741
	XOZ020	Metal counterweight for 4/5/6 level storage with pull-out filing cradles	410	190	8	224
	COZ048	Filing frame for suspension files A4	340	305	245	101
	ZTZ005	3 drawer insert, White MFC carcass with HPL drawer fronts (Grey (H12), Cappuccino (H13), Light Yellow (H14), Mint (H15) or White (H70))	370	305	330	355
	COZ053	6 stickers for fixing units together	-	-	-	20
	ZZZ058	Master key for AP locks	-	-	-	41
	ZZZ059	Removal key for AP locks	-	-	-	24
	ZZZ060	Cylinder lock with 2 keys for AP locks	-	-	-	26

Choice

Storage lockers



Choice modular MFC lockers are a creative and versatile solution for secure personal storage.

You can personalize your locker and create a variety of combinations or match the door colour with locker body. Choice locker cupboards can be a colourful accent in your office and create either an expressive or reserved image.

Create colourful combinations by mixing and matching carcass and door finishes.

Lockers are supplied with key locks as standard, optional combination or digital locks are available as well as 2 different door types – fully enclosed or with a cut-out for mail.

Office spaces are changing rapidly as more and more companies implement the activity-based work concept or hot desking system. Lockers cater to the needs of employees who spend majority of their time working outside the office or have flexible work hours as well as the resident workers and office visitors.

Range

W450mm, D500mm

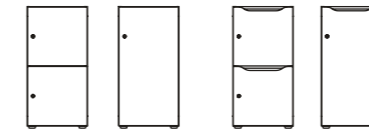

H917mm

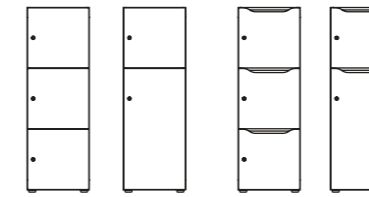

H1367mm

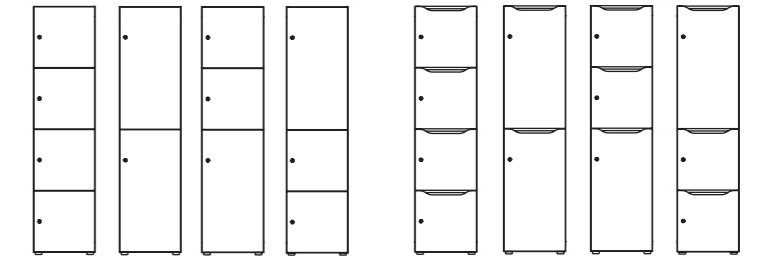

H1817mm

Technical details

Carcass, top, bottom & shelves

- 18mm MFC with 1mm ABS edging[†]
- Back: 18mm MFC

Doors with hinges

- 18mm MFC with 1mm ABS edging
- 18mm veneer faced chipboard with 1.5mm ABS edging
- 17.5 - 18mm HPL faced chipboard with 2mm ABS edging
- 107° opening angle with soft closing function

Top panels

- 18mm MFC with 1mm ABS edging
- 18mm chipboard, covered in wood veneer with 1.5mm edging

Plastic feet

- Black plastic height levelling legs, H17mm +10mm

P1 Locks

- Cylinder lock with retention (AP)

P2 Locks

- Combination lock (BP)

P3 Locks

- 4G series electronic keypad lock for assigned use (CP)*
- 4G series electronic keypad lock for shared use (CS)*
- 4G series electronic RFID lock for assigned use (DP)*
- 4G series electronic RFID lock for shared use (DS)*

Metal shelves

- Central powder coated metal shelf (external dimensions: 380 x 316 x H108 mm, 0.8mm thick)
- R/H powder coated metal shelf (external dimensions: 340 x 316 x H140 mm, 0.8mm thick)

Materials

Band A MFC

- Whitened Oak (D1)
- Amber Oak (D2)
- White (M1)
- Dark Grey (N1)
- Pearl Grey (N3)

Band B MFC

- Sand Ash (D3)
- Dark Walnut (D4)
- Grey Wood (D5)
- Cubanit Grey (N2)
- Black (J4)

Veneer









- Oak (AA)









HPL

- Grey (H12)
- Cappuccino (H13)
- Light Yellow (H14)
- Mint (H15)
- White (H70)







- G1: Band A MFC Carcass + Band A MFC Doors
- G2: Band A MFC Carcass + Band B MFC Doors
- G3: Band A MFC Carcass + Veneer / HPL Doors
- G4: Band B MFC Carcass + Band A MFC Doors
- G5: Band B MFC Carcass + Band B MFC Doors
- G6: Band B MFC Carcass + Veneer / HPL Doors





[†] Side walls will always have holes which can be hidden with plastic covers that match carcass colour. * Programming key and at least 1 manager key must be ordered with digital locks (CP, CS, DP, DS). RFID locks will work with all Mifare cards and HID iClass cards.

	CODE	DESCRIPTION	WIDTH	DEPTH	HEIGHT	G1 (£)	G2 (£)	G3 (£)	G4 (£)	G5 (£)	G6 (£)
	C2C090/P1	2 small doors, AP lock	450	500	917	416	421	542	486	497	617
	C2C090/P2	2 small doors, BP lock	450	500	917	538	542	658	606	617	727
	C2C090/P3	2 small doors, CP/CS/DP/DS lock	450	500	917	1,264	1,289	1,409	1,340	1,357	1,478
	C2C091/P1	1 large door, AP lock	450	500	917	301	323	446	357	375	497
	C2C091/P2	1 large door, BP lock	450	500	917	363	380	497	415	438	554
	C2C091/P3	1 large door, CP/CS/DP/DS lock	450	500	917	733	745	872	785	801	924
	C3C130/P1	3 small doors, AP lock	450	500	1367	596	614	793	689	700	886
	C3C130/P2	3 small doors, BP lock	450	500	1367	782	793	961	874	886	1,054
	C3C130/P3	3 small doors, CP/CS/DP/DS lock	450	500	1367	1,879	1,908	2,092	1,971	1,999	2,184
	C3C131/P1	1 small door (top), 1 large door (bottom), AP lock	450	500	1367	476	504	684	562	591	769
	C3C131/P2	1 small door (top), 1 large door (bottom), BP lock	450	500	1367	603	624	799	684	713	886
	C3C131/P3	1 small door (top), 1 large door (bottom), CP/CS/DP/DS lock	450	500	1367	1,335	1,365	1,543	1,423	1,445	1,630
	C4C180/P1	4 small doors, AP lock	450	500	1817	799	822	1,065	922	944	1,187
	C4C180/P2	4 small doors, BP lock	450	500	1817	1,043	1,065	1,291	1,163	1,187	1,412
	C4C180/P3	4 small doors, CP/CS/DP/DS lock	450	500	1817	2,508	2,548	2,791	2,631	2,670	2,912
	C4C181/P1	2 large doors, AP lock	450	500	1817	543	584	826	642	684	931
	C4C181/P2	2 large doors, BP lock	450	500	1817	666	706	935	769	809	1,039
	C4C181/P3	2 large doors, CP/CS/DP/DS lock	450	500	1817	1,404	1,439	1,681	1,508	1,538	1,786
	C4C182/P1	2 small doors (top), 1 large door (bottom), AP lock	450	500	1817	649	679	922	766	795	1,036
	C4C182/P2	2 small doors (top), 1 large door (bottom), BP lock	450	500	1817	829	863	1,088	945	980	1,204
	C4C182/P3	2 small doors (top), 1 large door (bottom), CP/CS/DP/DS lock	450	500	1817	1,932	1,965	2,215	2,047	2,087	2,330
	C4C183/P1	1 large door (top), 2 small doors (bottom), AP lock	450	500	1817	649	679	922	766	795	1,036
	C4C183/P2	1 large door (top), 2 small doors (bottom), BP lock	450	500	1817	829	863	1,088	945	980	1,204
	C4C183/P3	1 large door (top), 2 small doors (bottom), CP/CS/DP/DS lock	450	500	1817	1,932	1,965	2,215	2,047	2,087	2,330

	CODE	DESCRIPTION	WIDTH	DEPTH	HEIGHT	G1 (£)	G2 (£)	G3 (£)	G4 (£)	G5 (£)	G6 (£)
	C2C092/P1	2 small doors, with mail slot, AP lock	450	500	917	416	428	549	490	497	623
	C2C092/P2	2 small doors, with mail slot, BP lock	450	500	917	538	549	683	613	623	750
	C2C092/P3	2 small doors, with mail slot, CP/CS/DP/DS lock	450	500	917	1,282	1,293	1,415	1,351	1,363	1,485
	C2C093/P1	1 large door, with mail slot, AP lock	450	500	917	307	331	452	366	389	504
	C2C093/P2	1 large door, with mail slot, BP lock	450	500	917	366	389	504	425	447	562
	C2C093/P3	1 large door, with mail slot, CP/CS/DP/DS lock	450	500	917	741	751	879	793	811	936
	C3C132/P1	3 small doors, with mail slot, AP lock	450	500	1367	605	617	801	693	710	894
	C3C132/P2	3 small doors, with mail slot, BP lock	450	500	1367	785	801	998	877	894	1,090
	C3C132/P3	3 small doors, with mail slot, CP/CS/DP/DS lock	450	500	1367	1,900	1,917	2,095	1,992	2,010	2,187
	C3C133/P1	1 small door (top), 1 large door (bottom), with mail slot, AP lock	450	500	1367	487	514	694	574	602	780
	C3C133/P2	1 small door (top), 1 large door (bottom), with mail slot, BP lock	450	500	1367	607	636	816	694	723	902
	C3C133/P3	1 small door (top), 1 large door (bottom), with mail slot, CP/CS/DP/DS lock	450	500	1367	1,352	1,369	1,559	1,439	1,456	1,646
	C4C184/P1	4 small doors, with mail slot, AP lock	450	500	1817	812	829	1,071	932	950	1,192
	C4C184/P2	4 small doors, with mail slot, BP lock	450	500	1817	1,054	1,071	1,336	1,176	1,192	1,459
	C4C184/P3	4 small doors, with mail slot, CP/CS/DP/DS lock	450	500	1817	2,538	2,556	2,803	2,659	2,675	2,925
	C4C185/P1	2 large doors, with mail slot, AP lock	450	500	1817	560	606	842	658	710	942
	C4C185/P2	2 large doors, with mail slot, BP lock	450	500	1817	682	721	952	779	820	1,056
	C4C185/P3	2 large doors, with mail slot, CP/CS/DP/DS lock	450	500	1817	1,420	1,448	1,703	1,523	1,552	1,807
	C4C186/P1	2 small doors (top), 1 large door (bottom), with mail slot, AP lock	450	500	1817	658	693	934	774	814	1,052
	C4C186/P2	2 small doors (top), 1 large door (bottom), with mail slot, BP lock	450	500	1817	842	872	1,120	959	986	1,241
	C4C186/P3	2 small doors (top), 1 large door (bottom), with mail slot, CP/CS/DP/DS lock	450	500	1817	1,958	1,980	2,228	2,072	2,095	2,344
	C4C187/P1	1 large door (top), 2 small doors (bottom), with mail slot, AP lock	450	500	1817	658	693	934	774	814	1,052
	C4C187/P2	1 large door (top), 2 small doors (bottom), with mail slot, BP lock	450	500	1817	842	872	1,120	959	986	1,241
	C4C187/P3	1 large door (top), 2 small doors (bottom), with mail slot, CP/CS/DP/DS lock	450	500	1817	1,958	1,980	2,228	2,072	2,095	2,344

	CODE	DESCRIPTION	G1: Band A MFC			G2: Band B MFC	
			WIDTH	DEPTH	HEIGHT	G1 (£)	G2 (£)
	COZ058	Top panel for W450mm locker	450	500	16	29	40
	COZ059	Top panel for W900mm lockers	900	500	16	58	69
	COZ060	Top panel for W1350mm lockers	1350	500	16	81	103
	COZ061	Top panel for W1800mm lockers	1800	500	16	101	125

	CODE	DESCRIPTION	WIDTH	DEPTH	HEIGHT	RSP (£)
	COZ062	Metal shelf (right)	300	300	100	70
	COZ063	Metal shelf (central) for doors with mail slot	300	300	100	86
	ZZZ061	Metal hook for clothes	20	28	62	23
	ZZZ062	Glued acrylic name card holder	60	90	1.5	13
	ZZZ344	Manager key for electronic locks (1-2 recommended per office)*	-	-	-	134
	ZZZ345	Programming key for electronic locks (1 recommended per office)*	-	-	-	171

	CODE	DESCRIPTION	WIDTH	DEPTH	HEIGHT	RSP (£)
	ZZZ333	User card for DP/DS electronic locks	-	-	-	23
	ZZZ334	Code finding pin for BP lock	-	-	-	25
	ZZZ058	Master key for AP locks	-	-	-	41
	ZZZ063	Master key for BP locks	-	-	-	44
	ZZZ059	Removal key for AP locks	-	-	-	24
	ZZZ060	Cylinder lock with 2 keys for AP locks	-	-	-	26

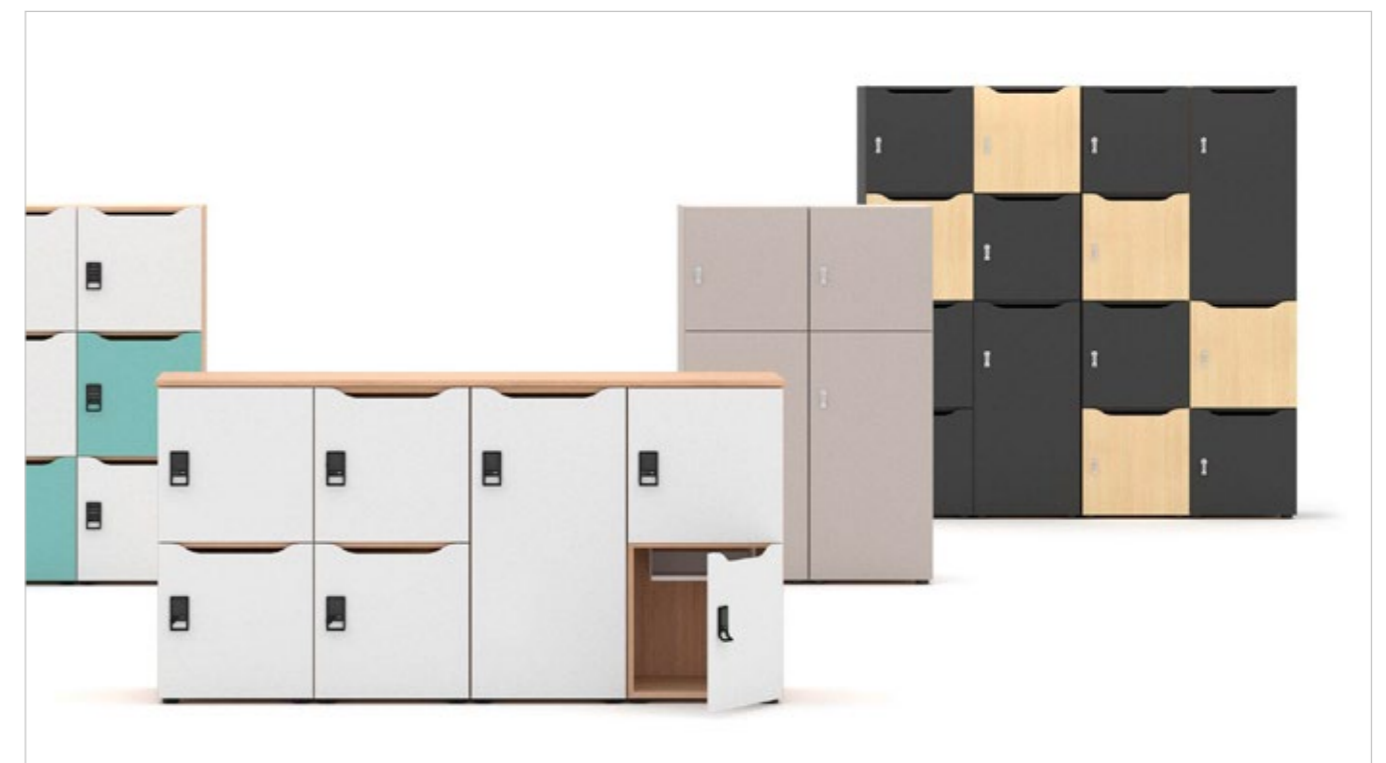

WorkLab

Multifunctional furniture



WorkLab is a multifunctional system that allows you to comfortably use a conference wall, whiteboard, temporary workplace, shelves or make a private space.

WorkLab consists of a single frame that can perform three different functions: a conference wall, a temporary workplace and shelves. Choose one of the pre-made base models and change the elements to create a piece of furniture that best meets your needs. The WorkLab option with a display screen is a mobile centre for team meetings and a tool to foster collaboration, with the possibility of hanging a whiteboard on the other side.

When combined with a desk, WorkLab makes a great temporary workplace. The display screen can be hung on either its front side or back side. WorkLab also acts as a playful partition and practical shelves. The back may be closed or semi-open. A display screen can also be hung on the back if required. Large castors are an integral part of the WorkLab design, ensuring the mobility of this piece of furniture and enhancing its unique image. Once you have customised the model that is right for you, you can also order a hook, shelf or side panels for additional functionality.

Range

Mobile shelving unit with 4 fixed shelves + semi-open back

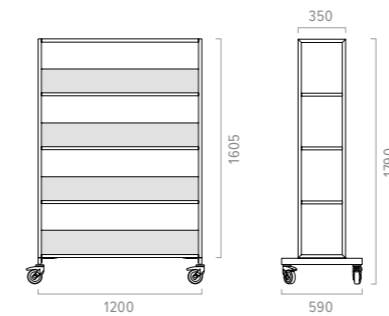

Mobile shelving unit with 2 fixed shelves, cabinet + semi-open back

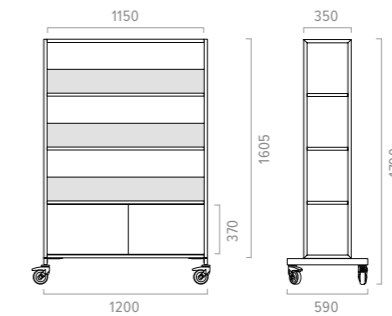

Mobile shelving unit with 2 fixed shelves + cabinet + back panel

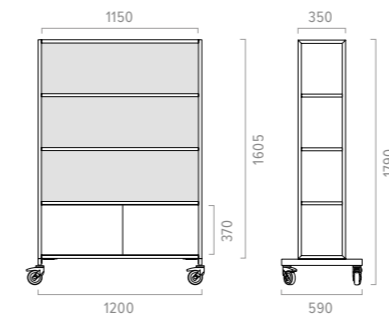

Mobile media wall with fixed shelf + cabinet + back panel

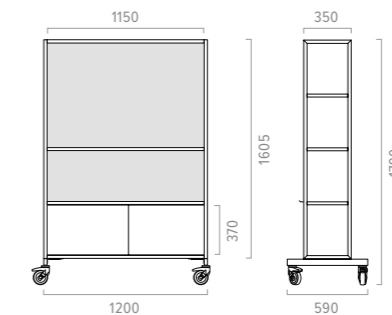

Mobile workstation with fixed cabinet + back panel

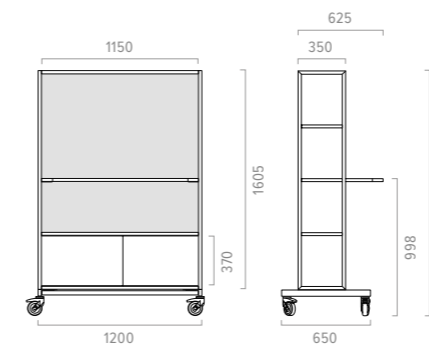

Desktops

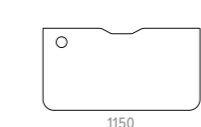

Side panel
Metal

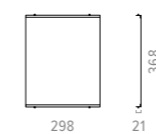

Fabric

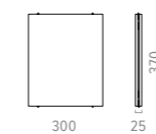

Side panel with hook
Metal

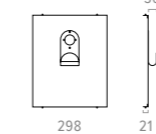

Fabric

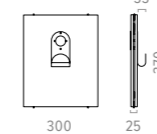

Side shelf



Hook



Screen holder

On metal

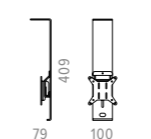

On fabric/MFC

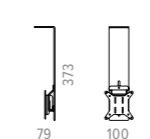

Materials

Band A MFC

- Whitened Oak (D1)
- Amber Oak (D2)
- White (M1)
- Pearl Grey (N3)
- Dark Grey (N1)

Band B MFC

- Sand Ash (D3)
- Dark Walnut (D4)
- Grey Wood (D5)
- Cubanit Grey (N2)
- Black (J4)

Metal

- Black (A)
- Grey (M)
- White (E)
- Dark Grey (T1)
- Deep Bronze (S1)
- Dusty Rose (ME1)
- Avacado Green (ME2)

Fabric Band A*

- Berta
- Camira Era

Fabric Band B*

- Camira Lucia

Fabric Band C*

- Camira Synergy
- Velito Presto
- Step / Step Melange

* Not all fabrics in these ranges are available on a standard lead time

Technical details

Metal frame

- Welded metal tube – 25x25 mm
- Powder coated metal

Metal lower bases

- Powder coated metal tube – 50x25 mm
- In all configurations the length is 590mm, except for workstation with a desktop – the length is 650mm

Footrest metal beam

- Only in the workstation configuration
- Powder coated metal (double painting) tube – Ø30mm

Castors

- Four swivel castors, Ø100mm
- With wheel brakes
- Rotates in all directions
- Load capacity - 100kg per castor
- Make sure that before relocating a unit with castors, all electrical components are disconnected from the main power source and hanged on hook of the side panel or placed securely

Shelves

- 25mm MFC (melamine) with 2mm ABS edging
- Load capacity – 25kg

Lower cabinet

- Top, bottom, side and back panels are made of 25mm MFC (melamine) with 2mm ABS edging
- Sliding doors are made of 16mm MFC (melamine) with 1mm ABS edging
- Dimensions: 280 x 566 x H370mm (inner, two sections)

Desktop

- Only in the workstation configuration, order separately
- 25mm MFC (melamine) with 2mm ABS edging
- The corners of desktop are rounded - R80mm
- Scallop for cable management: 350x40 mm
- Optional cut-out for a power socket integration

Fabric back panel

- Made of 16mm chipboard
- Covered with 3mm foam
- Upholstered with fabric

Fabric and whiteboard back panel

- Fabric side is made of 8mm MDF covered with 3mm foam
- Upholstered with fabric
- Whiteboard side is made of 12mm chipboard pressed in HPL with 1mm ABS edging

Perforated metal sheet back panel

- Perforated 1 mm metal sheet with a Ø8mm hole
- The back panel has three vertical sections with a bended central part (except a shelving unit configuration)
- Top and bottom welded with metal tube 20x20 mm
- The edges are welded with metal profile
- Matches the colour of the frame
- Powder coated metal

Fabric side panel

- With or without a metal hook for wire management
- 8mm MDF covered with 3mm foam
- Upholstered with fabric
- Double-sided panel hides an inner metal construction
- Metal brackets for mounting
- Load capacity of metal hook - 3kg
- Powder coated metal

Perforated metal sheet side panel

- With or without a metal hook for wire management
- Perforated 1 mm metal sheet with a Ø8mm hole
- Two edges are welded with metal profile
- Fixed with screws
- Load capacity of metal hook - 3kg
- Powder coated metal

Side shelf

- Powder coated metal
- Should be hanged only on the crossbars of the side frame
- Fixed with screws
- Load capacity - 10kg per shelf

Hook







- Powder coated metal
- Should be hanged only on the crossbars of the side frame
- Fixed with a screw
- Load capacity - 5 kg per hook

Screen holder

- Two types of holders: for perforated metal back and fabric back
- Powder coated metal
- VESA standard – 100x100 mm
- Recommended screen weight is up to 15kg
- Screws for screen fixing to VESA plate are not included

G1: Band A MFC

G2: Band B MFC

	CODE	DESCRIPTION	WIDTH	DEPTH	HEIGHT	G1 (£)	G2 (£)				
	ZWK001	Mobile shelving unit with 4 fixed shelves, semi-open back and set of side panels (4 pcs.)	1200	590 (350)*	1790	1,619	1,758				
	ZWK002	Mobile shelving unit with 2 fixed shelves, cabinet, semi-open back, set of side panels (4 pcs.), side shelf and hooks	1353	590 (350)*	1790	1,926	2,094				
	ZWL121	Mobile shelving unit with 4 fixed shelves and semi-open back	1200	590 (350)*	1790	1,294	1,433				
	ZWL122	Mobile shelving unit with 2 fixed shelves, cabinet and semi-open back	1200	590 (350)*	1790	1,514	1,682				
<p>G1: Band A MFC + Band A Fabric G2: Band B MFC + Band A Fabric</p>			<p>G3: Band A MFC + Band B Fabric G4: Band B MFC + Band B Fabric</p>			<p>G5: Band A MFC + Band C Fabric G6: Band B MFC + Band C Fabric</p>					
	CODE	DESCRIPTION	WIDTH	DEPTH	HEIGHT	G1 (£)	G2 (£)	G3 (£)	G4 (£)	G5 (£)	G6 (£)
	ZWK003	Mobile shelving unit with 2 fixed shelves, cabinet, back panel and set of side panels (6 pcs.)	1200	590 (350)*	1790	2,204	2,344	2,338	2,477	2,750	2,889
	ZWK005	Mobile media wall with fixed shelf, cabinet, whiteboard back panel, TV screen, side panels and shelves	1448	590 (350)*	1790	2,494	2,610	2,558	2,674	2,738	2,854

G1: Band A MFC + Band A Fabric G2: Band B MFC + Band A Fabric		G3: Band A MFC + Band B Fabric G4: Band B MFC + Band B Fabric		G5: Band A MFC + Band C Fabric G6: Band B MFC + Band C Fabric						
CODE	DESCRIPTION	WIDTH	DEPTH	HEIGHT	G1 (£)	G2 (£)	G3 (£)	G4 (£)	G5 (£)	G6 (£)



ZWK004	Mobile workstation with fixed cabinet and back panel, with desktop, side panels, side shelf, hooks and wiring solutions	1356	745 (350)*	1790	2,361	2,489	2,471	2,599	2,825	2,953
--------	---	------	------------	------	-------	-------	-------	-------	-------	-------



ZWL123	Mobile shelving unit with 2 fixed shelves, cabinet and back panel	1200	590 (350)*	1790	1,735	1,874	1,798	1,938	2,054	2,193
--------	---	------	------------	------	-------	-------	-------	-------	-------	-------

G1: Band A MFC + Band A Fabric G2: Band B MFC + Band A Fabric		G3: Band A MFC + Band B Fabric G4: Band B MFC + Band B Fabric		G5: Band A MFC + Band C Fabric G6: Band B MFC + Band C Fabric						
CODE	DESCRIPTION	WIDTH	DEPTH	HEIGHT	G1 (£)	G2 (£)	G3 (£)	G4 (£)	G5 (£)	G6 (£)



ZWK003	Mobile shelving unit with 2 fixed shelves, cabinet, back panel and set of side panels (6 pcs.)	1200	590 (350)*	1790	2,204	2,344	2,338	2,477	2,750	2,889
--------	--	------	------------	------	-------	-------	-------	-------	-------	-------



ZWK005	Mobile media wall with fixed shelf, cabinet, whiteboard back panel, TV screen, side panels and shelves	1448	590 (350)*	1790	2,494	2,610	2,558	2,674	2,738	2,854
--------	--	------	------------	------	-------	-------	-------	-------	-------	-------



ZWK004	Mobile workstation with fixed cabinet and back panel, with desktop, side panels, side shelf, hooks and wiring solutions	1356	745 (350)*	1790	2,361	2,489	2,471	2,599	2,825	2,953
--------	---	------	------------	------	-------	-------	-------	-------	-------	-------





ZWL123	Mobile shelving unit with 2 fixed shelves, cabinet and back panel	1200	590 (350)*	1790	1,735	1,874	1,798	1,938	2,054	2,193
--------	---	------	------------	------	-------	-------	-------	-------	-------	-------









ZWL12A	Mobile shelving unit with 2 fixed shelves, cabinet and whiteboard back panel	1200	590 (350)*	1790	2,152	2,291	2,193	2,332	2,326	2,465
--------	--	------	------------	------	-------	-------	-------	-------	-------	-------







CODE	DESCRIPTION	WIDTH	DEPTH	HEIGHT	G1 (£)	G2 (£)	G3 (£)	G4 (£)	G5 (£)	G6 (£)
ZWL124	Mobile media wall with fixed shelf, cabinet and back panel	1200	590 (350)*	1790	1,659	1,775	1,723	1,839	1,978	2,094
ZWL12B	Mobile media wall with fixed shelf, cabinet and whiteboard back panel	1200	590 (350)*	1790	2,077	2,193	2,117	2,233	2,251	2,367
ZWL125	Mobile workstation with fixed cabinet and back panel, without desktop (desktop must be ordered)	1200	650 (350)*	1790	1,665	1,758	1,729	1,822	1,984	2,077
ZWL12C	Mobile workstation with fixed cabinet and whiteboard back panel, without desktop (desktop must be ordered)	1200	650 (350)*	1790	2,083	2,175	2,123	2,216	2,257	2,349







		G1: Band A MFC			G2: Band B MFC	
CODE	DESCRIPTION	WIDTH	DEPTH	HEIGHT	G1 (£)	G2 (£)
ZWK006	Mobile shelving unit with 2 fixed shelves, cabinet, back panel, set of side panels (4 pcs.) and side shelves (2 pcs)	1448	590 (350)*	1790	2,442	2,581
ZWK007	Mobile media wall with fixed shelf, cabinet, back panel, side panels and shelf, hooks and wiring solutions	1356	590 (350)*	1790	2,500	2,616
ZWK008	Mobile workstation with fixed cabinet and back panel, with desktop, side panels, side shelf, hooks and wiring solutions	1356	745 (350)*	1790	2,564	2,692







		G1: Band A MFC		G2: Band B MFC				
	CODE	DESCRIPTION	WIDTH	DEPTH	HEIGHT	G1 (£)	G2 (£)	
	ZWL126	Mobile shelving unit with 2 fixed shelves, cabinet and back panel	1200	590 (350)*	1790	2,013	2,152	
	ZWL127	Mobile media wall with fixed shelf, cabinet and back panel	1200	590 (350)*	1790	1,949	2,065	
	ZWL128	Mobile workstation with fixed cabinet and back panel, without desktop (desktop must be ordered)	1200	650 (350)*	1790	1,955	2,048	

		G1: Band A MFC		G2: Band B MFC				
	CODE	DESCRIPTION	WIDTH	DEPTH	HEIGHT	G1 (£)	G2 (£)	
	ZWK001	Mobile shelving unit with 4 fixed shelves, semi-open back and set of side panels (4 pcs.)	1200	590 (350)*	1790	1,619	1,758	
	ZWK002	Mobile shelving unit with 2 fixed shelves, cabinet, semi-open back, set of side panels (4 pcs.), side shelf and hooks	1353	590 (350)*	1790	1,926	2,094	
	ZWL121	Mobile shelving unit with 4 fixed shelves and semi-open back	1200	590 (350)*	1790	1,294	1,433	
	ZWL122	Mobile shelving unit with 2 fixed shelves, cabinet and semi-open back	1200	590 (350)*	1790	1,514	1,682	

		G1: Band A MFC		G2: Band B MFC				
	CODE	DESCRIPTION	WIDTH	DEPTH	HEIGHT	G1 (£)	G2 (£)	
	ZWL111	Desktop with a scallop for wire management	1150	600	25	99	134	
	ZWL112	Desktop with a scallop and cut-out for power socket	1150	600	25	99	134	

		G1: Band A Fabric		G2: Band B Fabric		G2: Band C Fabric		
	CODE	DESCRIPTION	WIDTH	DEPTH	HEIGHT	G1 (£)	G2 (£)	G3 (£)
	ZWZ001	Side panel (1 pcs.)	300	25	370	82	93	116
	ZWZ002	Set of side panels (2 pcs.)	300	25	370	157	180	232
	ZWZ003	Set of side panels (4 pcs.)	300	25	370	319	360	459
	ZWZ004	Set of side panels (6 pcs.)	300	25	370	476	534	691
	ZWZ015	Set of side panels (8 pcs.)	300	25	370	633	714	917
	ZWZ005	Side panel with a hook for wire management (1 pcs.)	300	61	370	105	116	140

	CODE	DESCRIPTION	WIDTH	DEPTH	HEIGHT	GBP (£)
	ZWZ006	Side panel (1 pcs.)	298	21	369	76
	ZWZ007	Set of side panels (2 pcs.)	298	21	369	151
	ZWZ008	Set of side panels (4 pcs.)	298	21	369	296
	ZWZ009	Set of side panels (6 pcs.)	298	21	369	447
	ZWZ016	Set of side panels (8 pcs.)	298	21	369	592
	ZWZ010	Side panel with a hook for wire management (1 pcs.)	298	54	369	105

	CODE	DESCRIPTION	WIDTH	DEPTH	HEIGHT	GBP (£)
	ZWZ011	Hook	25	52	65	24
	ZWZ012	Side shelf	295	150	100	64
	ZWZ013	Screen holder for perforated metal back	100	79	409	111
	ZWZ014	Screen holder for fabric back	100	79	373	105
	DNZ046	Cable tray L703 mm (1 pcs.)	703	150	105	145
	S1-1P3C(1A/2C)1D1H-BK/02	Metalicon Solo Plus power socket with integrated 18W USB-A & 45W USB-C smart charge, 1 x HDMI data transfer port and 1 x Cat6 RJ45 data transfer port, and 2m power cable (Type G plug to GST female), black <i>Must be ordered with ZWL112 desktop</i>	Ø110		65	200
	UPMA-3P-SV/02	Powerlink power module, 3 power sockets and 2m power cable (Type G plug to GST female)	264	70	60	60

Combus

Modular zoning shelving



Combus is a modular shelving system designed for shaping and dividing spaces, different types of shelving, are designed for open space, against a wall or on top of Choice cabinets. Combus is functional, has an easily adaptable design and is environmentally friendly.

Choose from closed or open shelving, with boxes and drawers. Use a book-end as an additional accessory for orderly storage of books. With the planter boxes, you can easily add plants to create a biophilic office environment. The Combus system includes the possibility of attaching a screen, making it a great

solution for quick discussions. The cable routing from the screen to the floor is well thought out, with a metal duct leading from the screen to a cut-out at the bottom of the frame, then through the cut-out and under the plinth to an electrical socket.

Subtle design elements help you create character including a PET felt storage basket, metal planter box and a metal book-end.

Combine different finishes, such as metal, melamine and PET felt, to create unique combinations.

Range

Shelving units - modular configurations

3H start and end modules

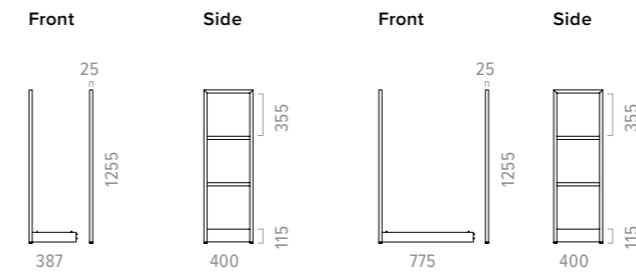

3H extension modules

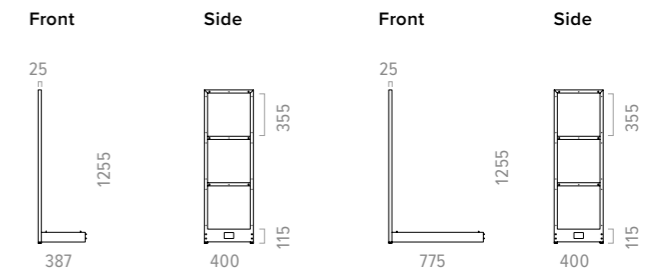

4H start and end modules

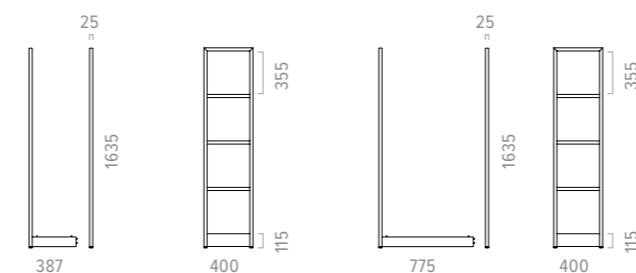

4H extension modules

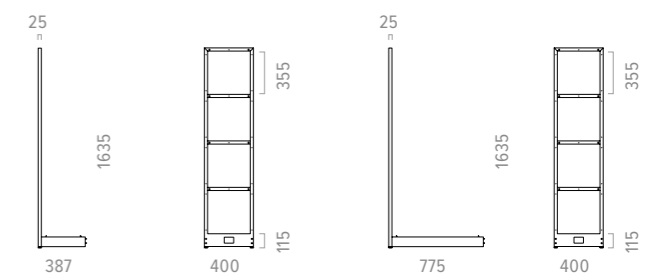

5H start and end modules

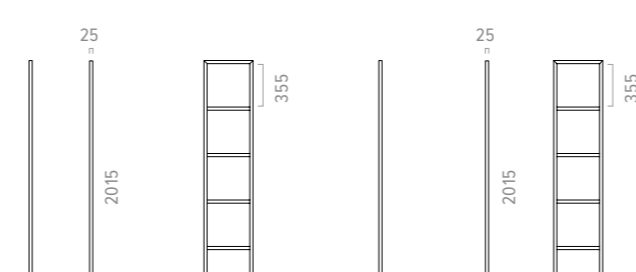

5H extension modules

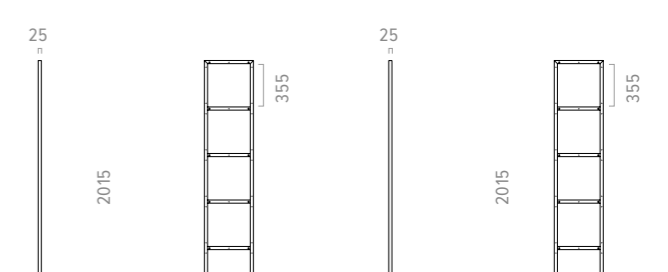

6H start and end modules

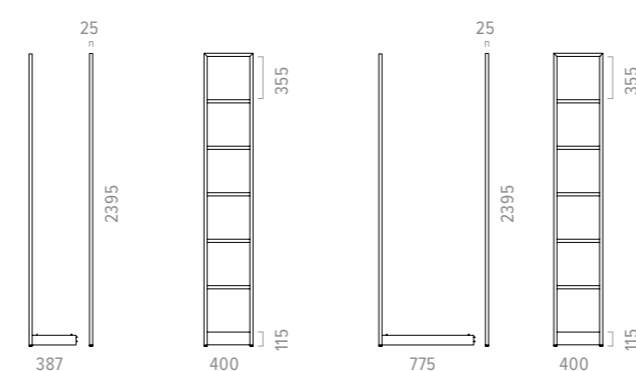

6H extension modules

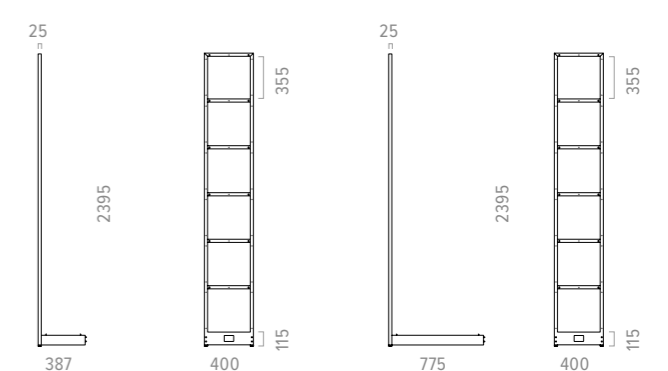

Shelves



Open and closed shelf boxes

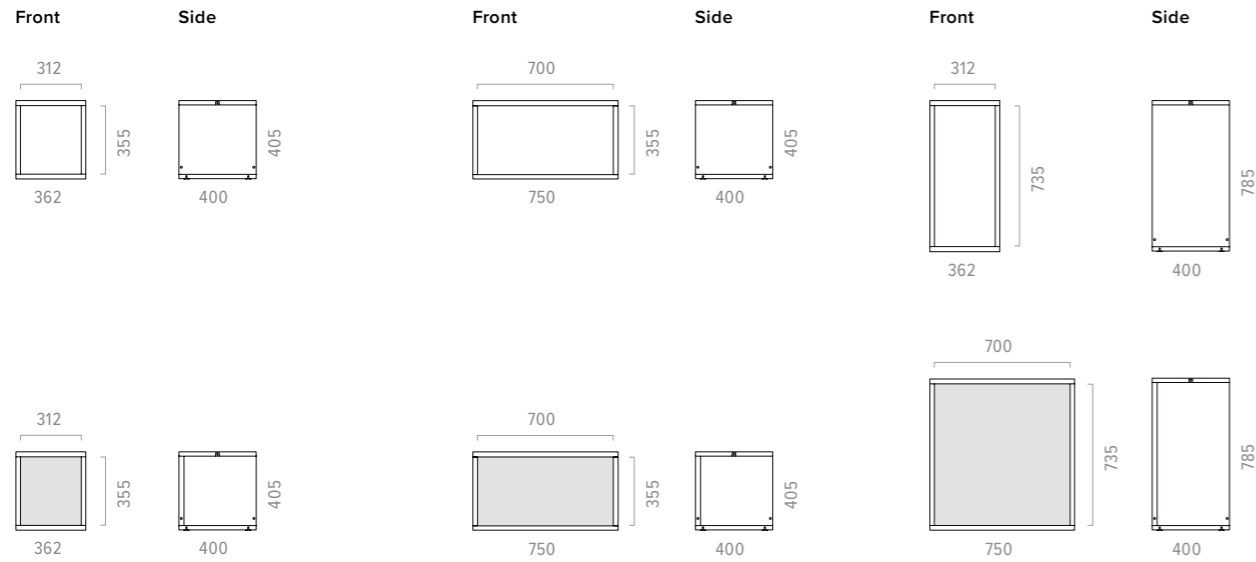

Planter boxes

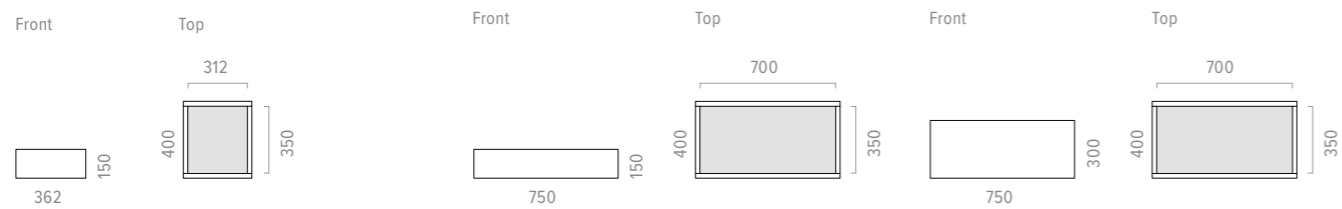

Cabinet with drawer

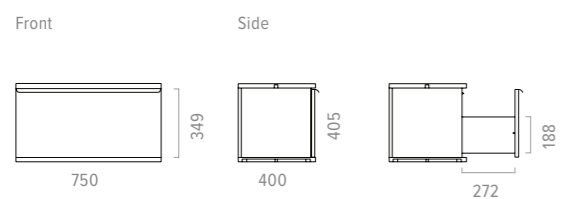

Planter shelf units - ready-made configurations

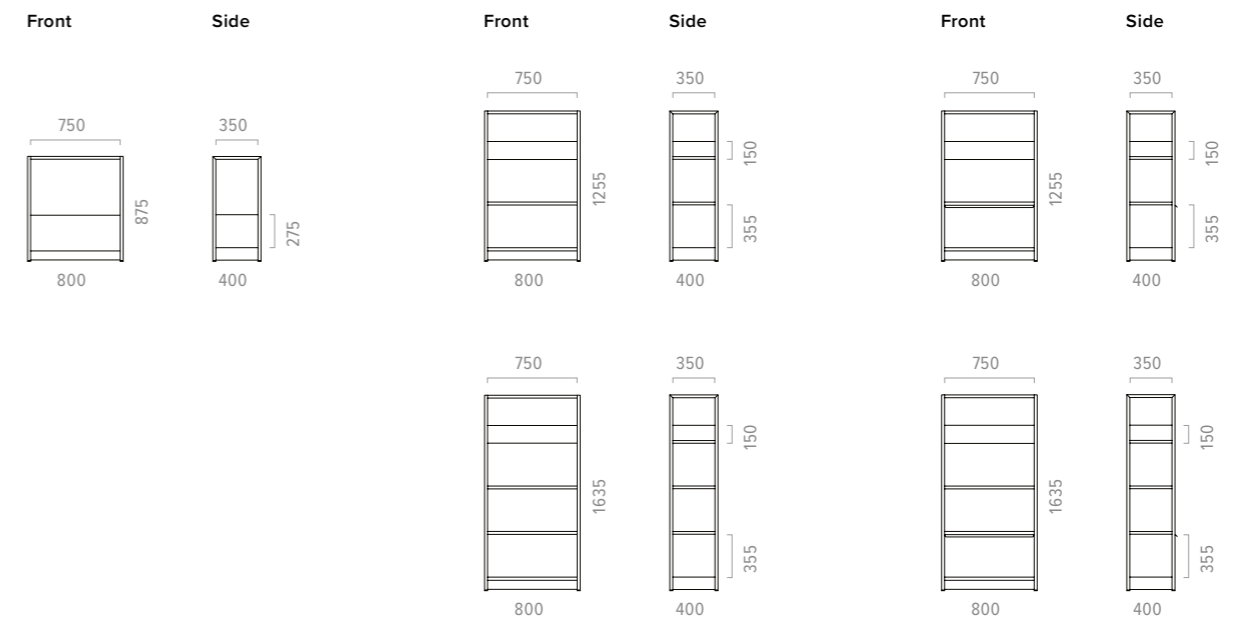

Shelving units for mounting on Choice cabinets - ready-made configurations

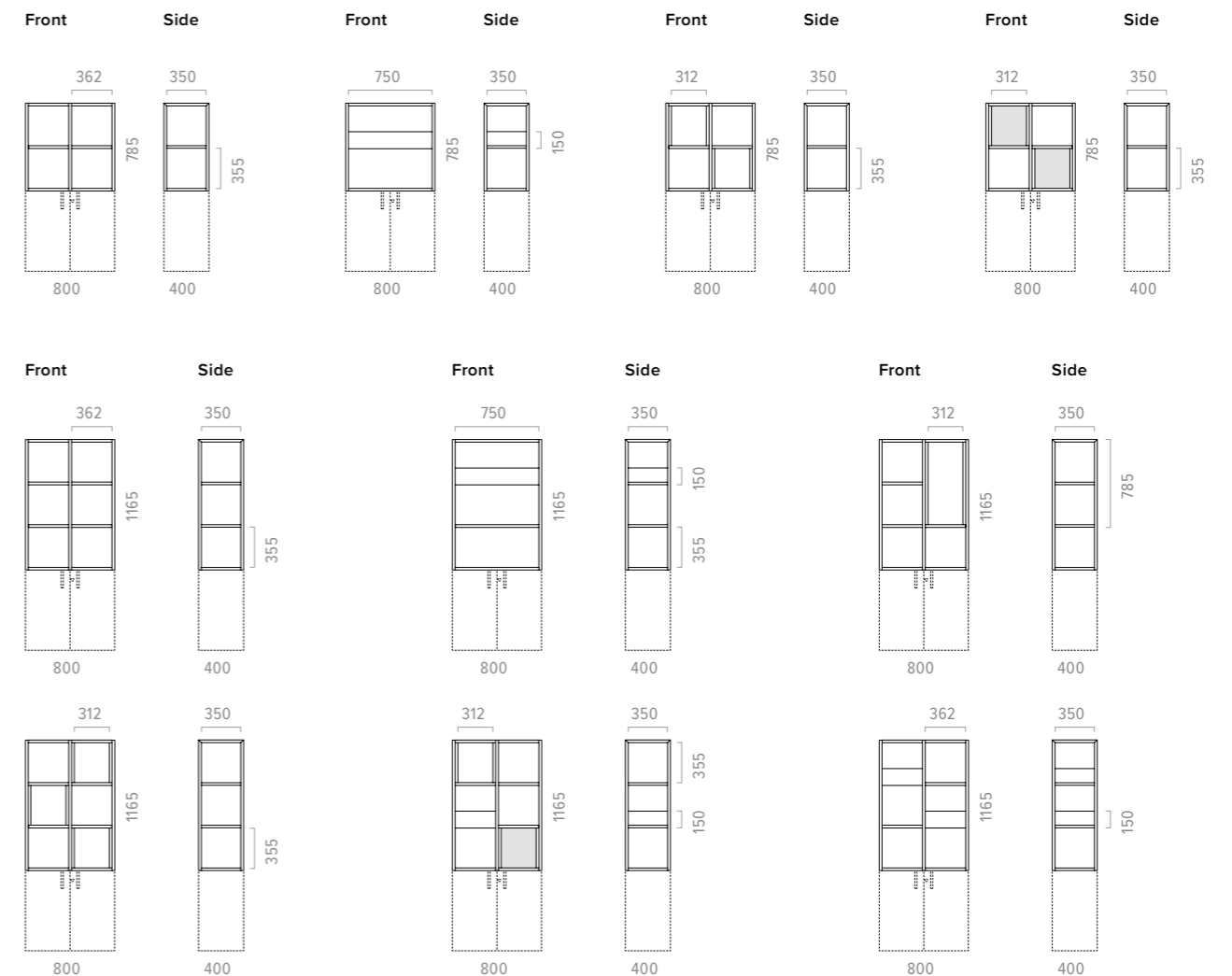

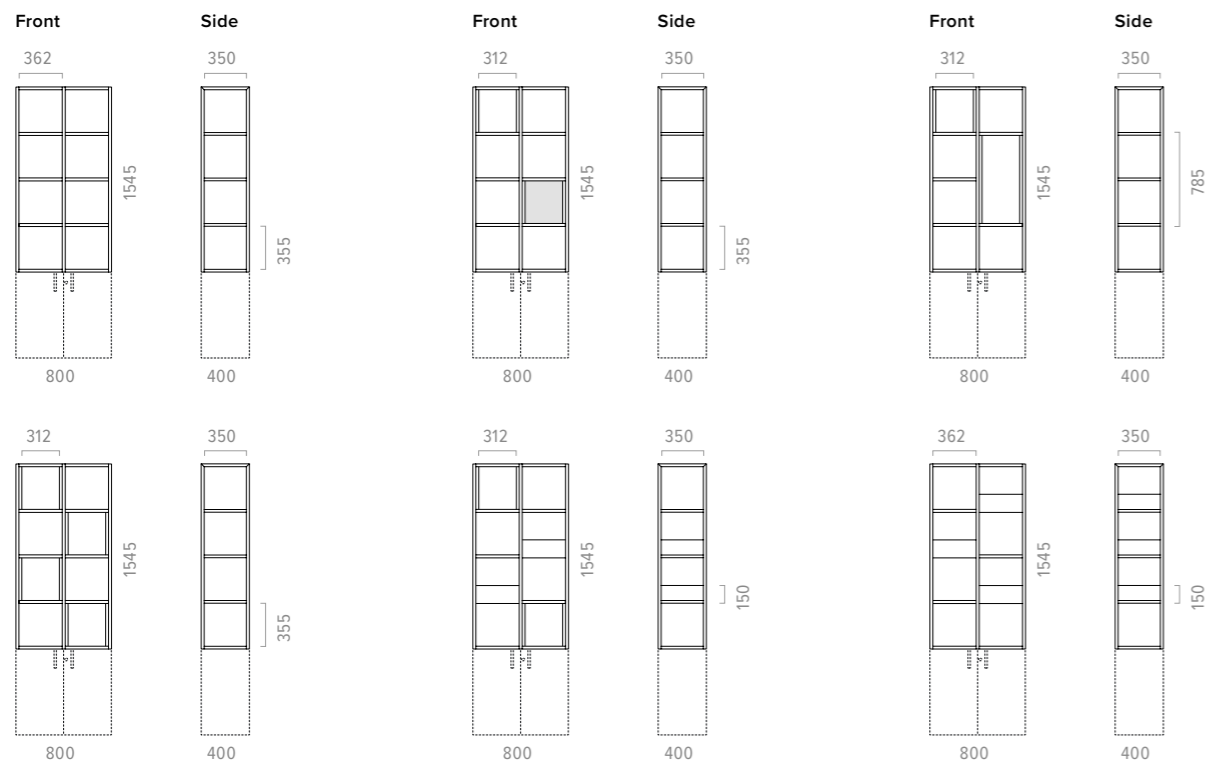

Back panels

Melamine

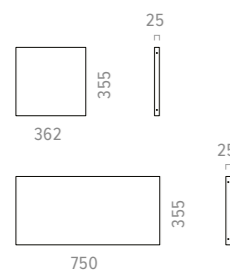

PET felt

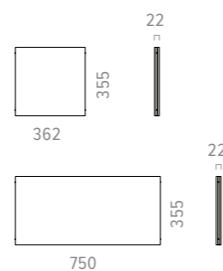

Perforated metal

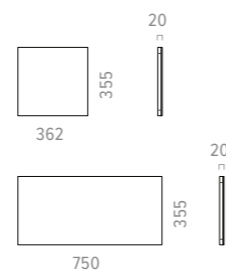

Metal planter boxes



Metal screen holders

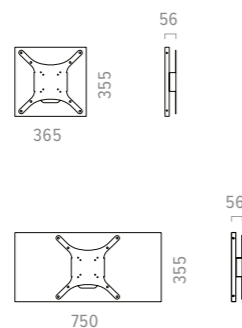

Metal cable tray for cable management



Metal book-ends



PET felt basket

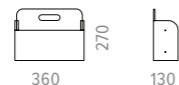

Technical details

Shelving unit

Shelves

- 25mm MFC with 2mm ABS edging
- Load capacity for 362mm width– 20kg
- Load capacity for 750mm width– 25kg

Shelf box

- 25mm MFC with 2mm ABS edging
- Available with open or closed back
- Load capacity for 362mm width– 20kg
- Load capacity for 750mm width– 25kg

Planter box

- 25mm MFC with 2mm ABS edging
- Load capacity for 362mm width– 20kg
- Load capacity for 750mm width– 25kg

Cabinet with drawer

- Top / bottom made of 25mm MFC with 2mm ABS edging
- Front, sides and back panel are made of 18mm MFC with 1mm ABS edging
- Drawer box made of 12mm MFC with 1mm ABS edging
- Soft closing function, partial extension with hidden slides
- Opening with a handle
- Handle made of metal sheet, powder coated
- Load capacity – 20kg

Frame

- 25x25 mm welded metal tube
- Bottom made of bent sheet metal, 350x25x150 mm
- Plastic feet with height levelling (+10mm)
- Powder coated metal frame construction is easy to assemble and disassemble

Plinths

- 362x80x25 mm and 750x80x25 mm, powder coated bent sheet metal

Connecting component

- 95x95mm metal plates, made of 1.5mm steel

Fixing components

- Fittings for fixing to the floor (included in the package)
- Set of fittings for mounting to the wall (order separately)
- Counterweight (order separately), made of 25mm MFC with 0.5mm ABS edging
- For more details about fixing types and the right selection of them, please read additional information

Planter shelf unit

Ready-made configurations

- Metal frame + planter box
- Metal frame + 2 shelves + planter box
- Metal frame + planter box + cabinet with drawer
- Metal frame + 3 shelves, planter box
- Metal frame + shelf, planter box + cabinet with drawer

Frame

- 25x25 mm powder coated welded metal tube
- Top frame metal connector 750x25x25 mm
- Bottom made of bent sheet metal, 350x25x150 mm
- Plastic feet with height levelling (+10mm)
- Metal frame construction is easy to assemble and disassemble

Plinths

- 362x80x25 mm and 750x80x25 mm, powder coated metal bent sheet metal

Connecting component

- For shelves combination connection
- 95x95 mm - made of 1.5mm steel

Fixing components

- Fittings for fixing to the floor (included in the package)
- Fittings for mounting to the wall (order separately)
- Counterweight (order separately), made of 25mm MFC with 0.5 mm ABS edging
- For more details about fixing types and the right selection of them, please read additional information

Shelves

- 25 mm MFC with 2mm ABS edging
- Load capacity for 362mm width – 20kg
- Load capacity for 750mm width – 25kg

Planter box

- 25mm MFC with 2mm ABS edging
- Available in 2 sizes: 750x400x300 mm or 750x400x150 mm
- Load capacity for 362mm width – 20kg
- Load capacity for 750mm width – 25kg

Cabinet with drawer

- Top and bottom 25mm MFC with 2mm ABS edging
- Front, sides and back panel are made of 18mm MFC with 1mm ABS edging
- Drawer box made of 12mm MFC with 1mm ABS edging
- Soft closing function, partial extension with hidden slides
- Handle made of metal sheet, powder coated.
- Load capacity – 20kg

Shelving unit for mounting on cabinets**Ready-made configurations**

- Four different 2H combinations
- Six different 3H combinations
- Six different 4H combinations

Frame

- 25x25 mm powder coated welded metal tube
- Bottom made of welded sheet metal, 350x25x105 mm

Shelves

- 25mm MFC with 2mm ABS edging
- Load capacity for 362mm width – 20kg
- Load capacity for 750mm width – 25kg

Shelf box

- 25mm MFC with 2mm ABS edging
- Available with open or closed back
- Load capacity for 362mm width – 20kg
- Load capacity for 750mm width – 25kg

Planter box

- 25mm MFC with 2 mm ABS edging
- Load capacity for 362mm width – 20kg
- Load capacity for 750mm width – 25kg

Back panel

- 25mm MFC with 2mm ABS edging

PET felt back panel

- 4mm plywood covered with 9mm PET fibreboard from both sides

Perforated metal sheet back panel

- 1mm powder coated metal sheet with perforated Ø8mm holes
- Edges are welded with metal profile

Metal planter box

- 1mm powder coated welded sheet metal
- Two sizes: 362x410x160 mm and 750x410x160 mm
- Placed on the shelves

Screen holder

- Screen holder base is made from 1.5mm powder coated metal sheet
- VESA plate is made of 2mm powder coated metal sheet
- VESA standard – 75x75 mm, 100x100 mm, 200x200 mm, 300x300 mm
- Recommended screen weight is up to 15kg
- Recommended screen size is up to 55"
- Screws for screen fixing to VESA plate are not included

Cable tidy

- 1mm powder coated bent sheet metal - 1245x51x12 mm
- Attached with two screws to the shelves above and with metal pins under the plinth below

Book-end

- 1mm powder coated bent sheet metal - 250x160x230 mm

Basket

- 9mm PET fibreboard
- Black painted or nickel-plated binding screws – 15mm
- Load capacity – 3kg

Materials

Band A MFC

Whitened Oak (D1)
Amber Oak (D2)
White (M1)
Pearl Grey (N3)
Dark Grey (N1)

Band B MFC

Sand Ash (D3)
Dark Walnut (D4)
Grey Wood (D5)
Cubanit Grey (N2)
Black (J4)



Metal

Black (A)
Grey (M)
White (E)
Dark Grey (T1)
Deep Bronze (S1)
Dusty Rose (ME1)
Avacado Green (ME2)





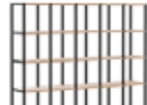

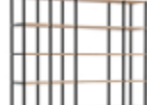
PET Felt 





Grey (B18)
Sand (B19)
Green (B44)
Dark Blue (B50)
Blue (B51)
Coral Pink (B56)
Chestnut (B53)
Dark Pink (B52)
Dark Grey (B54)
Lime (B55)
Light Grey (B58)
Light Beige (B57)









 Eco friendly









	CODE	DESCRIPTION	G1: Band A MFC			G2: Band B MFC	
			WIDTH	DEPTH	HEIGHT	G1 (£)	G2 (£)
	ZCK001	Combination of metal frame and shelves. 3H	1960	400	1255	2,346	2,502
	ZCK002	Combination of metal frame and shelves. 4H	1960	400	1635	2,798	3,006
	ZCK003	Combination of metal frame and shelves. 5H	1960	400	2015	3,354	3,588
	ZCK004	Combination of metal frame and shelves. 6H	1961	400	2395	3,354	3,614



















G1: Band A MFC Shelves + Boxes		G3: Band B MFC Shelves + Band A MFC Boxes							
G2: Band A MFC Shelves + Band B MFC Boxes		G4: Band B MFC Shelves + Boxes							
	CODE	DESCRIPTION	WIDTH	DEPTH	HEIGHT	G1 (£)	G2 (£)	G3 (£)	G4 (£)
	ZCK005	Combination of metal frame, shelves, cabinet with drawer and perforated metal back panels. 4H	2350	400	1635	3,578	3,734	3,718	3,874
	ZCK006	Combination of metal frame, shelves, shelves boxes and PET felt back panels. 5H	2349	400	2015	4,129	4,306	4,311	4,488
	ZCK007	Combination of metal frame, shelves, shelves boxes, cabinet with drawer and PET felt back panels. 4H	1961	400	1635	3,245	3,401	3,360	3,516
	ZCK008	Combination of metal frame, shelves, shelves boxes, metal planter boxes and perforated metal back panels. 4H	2349	400	1635	3,594	3,672	3,776	3,854
	ZCK009	Combination of metal frame, shelves, shelves boxes and PET felt back panels. 5H	1960	400	2015	4,207	4,358	4,394	4,545
	ZCK010	Combination of metal frame, shelves, shelves boxes, metal planter boxes, screen holder and perforated metal back panels. 5H	2349	400	2015	4,166	4,244	4,389	4,467
	ZCK011	Combination of metal frame, shelves, shelves boxes and perforated metal back panels. 6H	2736	400	2395	5,575	5,861	5,798	6,084









	CODE	DESCRIPTION	WIDTH	DEPTH	HEIGHT	G1 (£)	G2 (£)	G3 (£)	G4 (£)
	ZCK012	Combination of metal frame, shelves, shelves boxes and PET felt back panels. 4H	2347	400	1635	4,446	4,727	4,566	4,847
	ZCK013	Combination of metal frame, shelves, shelves boxes, cabinet with drawer and PET felt back panels. 5H	1961	400	2015	4,202	4,483	4,301	4,582
	ZCK014	Combination of metal frame, shelves, shelves boxes, metal planter boxes and perforated metal back panels. 5H	2736	400	2015	5,476	5,772	5,642	5,939
	ZCK015	Combination of metal frame, shelves, shelves boxes, cabinet with drawer and perforated metal back panels. 6H	2349	400	2395	4,800	5,107	4,961	5,268





	CODE	DESCRIPTION	WIDTH	DEPTH	HEIGHT	RSP (£)
	ZCA340	Set of metal frames and plinth for shelves. Start and end module.	412	400	1255	401
	ZCA341	Metal frame and plinth for shelves. Extension module.	387	400	1255	240
	ZCA380	Set of metal frames and plinth for shelves. Start and end module.	800	400	1255	463
	ZCA381	Metal frame and plinth for shelves. Extension module.	775	400	1255	302
	ZCA440	Set of metal frames and plinth for shelves. Start and end module.	412	400	1635	474
	ZCA441	Metal frame and plinth for shelves. Extension module.	387	400	1635	276
	ZCA480	Set of metal frames and plinth for shelves. Start and end module.	800	400	1635	536
	ZCA481	Metal frame and plinth for shelves. Extension module.	775	400	1635	338



	CODE	DESCRIPTION	WIDTH	DEPTH	HEIGHT	RSP (£)
	ZCA540	Set of metal frames and plinth for shelves. Start and end module.	412	400	2015	557
	ZCA541	Metal frame and plinth for shelves. Extension module.	387	400	2015	323
	ZCA580	Set of metal frames and plinth for shelves. Start and end module.	800	400	2015	619
	ZCA581	Metal frame and plinth for shelves. Extension module.	775	400	2015	385
	ZCA640	Set of metal frames and plinth for shelves. Start and end module.	412	400	2395	630
	ZCA641	Metal frame and plinth for shelves. Extension module.	387	400	2395	354
	ZCA680	Set of metal frames and plinth for shelves. Start and end module.	800	400	2395	692
	ZCA681	Metal frame and plinth for shelves. Extension module.	775	400	2395	416









		G1: Band A MFC			G2: Band B MFC				
	CODE	DESCRIPTION	WIDTH	DEPTH	HEIGHT	G1 (£)	G2 (£)	G3 (£)	G4 (£)
	ZCA330	Set of 4 shelves	362	400	25	198	229		
	ZCA370	Set of 4 shelves	750	400	25	318	375		
		G1: Band A MFC Shelves + Boxes				G3: Band B MFC Shelves + Band A MFC Boxes			
		G2: Band A MFC Shelves + Band B MFC Boxes				G4: Band B MFC Shelves + Boxes			
	CODE	DESCRIPTION	WIDTH	DEPTH	HEIGHT	G1 (£)	G2 (£)	G3 (£)	G4 (£)
	ZCA331	Set of 2 shelves and open shelf box	362	400	25 / 405	255	286	271	302
	ZCA332	Set of 2 shelves and closed shelf box	362	400	25 / 405	281	323	297	338
	ZCA333	Set of 1 shelf and open shelf box	362	400	25 / 785	260	307	266	312
	ZCA334	Set of 3 shelves and planter box	362	400	25 / 150	260	286	281	307
	ZCA335	Set of shelf, planter box and closed shelf box	362	400	25 / 150 / 405	344	411	349	416
	ZCA371	Set of 2 shelves and open shelf box	750	400	25 / 405	375	422	406	453









	CODE	DESCRIPTION	WIDTH	DEPTH	HEIGHT	G1 (£)	G2 (£)	G3 (£)	G4 (£)
	ZCA372	Set of 2 shelves and closed shelf box	750	400	25 / 405	432	484	463	515
	ZCA373	Set of 3 shelves and planter box	750	400	25 / 150	406	442	453	489
	ZCA374	Set of 2 shelves and shelf cabinet with drawer (without lock) Painted metal handle	750	400	25 / 405	588	640	619	671
	ZCA375	Set of shelf, planter box and shelf cabinet with drawer (without lock)	750	400	25 / 150 / 405	676	765	692	780
		G1: Band A MFC				G2: Band B MFC			
	CODE	DESCRIPTION	WIDTH	DEPTH	HEIGHT	G1 (£)	G2 (£)	G3 (£)	G4 (£)
	ZCA430	Set of 5 shelves	362	400	25	245	286		
	ZCA470	Set of 5 shelves	750	400	25	396	468		
		G1: Band A MFC Shelves + Boxes				G3: Band B MFC Shelves + Band A MFC Boxes			
		G2: Band A MFC Shelves + Band B MFC Boxes				G4: Band B MFC Shelves + Boxes			
	ZCA431	Set of 3 shelves and open shelf box	362	400	25 / 405	307	338	328	359
	ZCA432	Set of 3 shelves and closed shelf box	362	400	25 / 405	333	375	354	396







G1: Band A MFC Shelves + Boxes		G3: Band B MFC Shelves + Band A MFC Boxes						
G2: Band A MFC Shelves + Band B MFC Boxes		G4: Band B MFC Shelves + Boxes						
CODE	DESCRIPTION	WIDTH	DEPTH	HEIGHT	G1 (£)	G2 (£)	G3 (£)	G4 (£)
 ZCA435	Set of shelf, closed and open shelf boxes	362	400	25 / 405	390	463	396	468
 ZCA433	Set of 2 shelves and open shelf box	362	400	25 / 785	307	354	323	370
 ZCA434	Set of 4 shelves and planter box	362	400	25 / 150	307	333	338	364
 ZCA436	Set of 3 shelves and 2 planter boxes	362	400	25 / 150	370	422	390	442
 ZCA437	Set of 2 shelves, planter box and closed shelf box	362	400	25 / 150 / 405	390	458	406	474
 ZCA471	Set of 3 shelves and open shelf box	750	400	25 / 405	453	500	500	546
 ZCA472	Set of 3 shelves and closed shelf box	750	400	25 / 405	510	562	557	609
 ZCA475	Set of shelf, closed and open shelf boxes	750	400	25 / 405	567	666	583	682



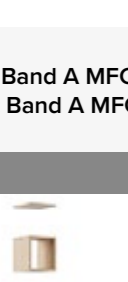



CODE	DESCRIPTION	WIDTH	DEPTH	HEIGHT	G1 (£)	G2 (£)	G3 (£)	G4 (£)
 ZCA476	Set of 3 shelves and 2 planter boxes	750	400	25 / 150	572	645	619	692
 ZCA477	Set of 2 shelves and closed shelf box	750	400	25 / 785	541	624	572	656
 ZCA473	Set of 4 shelves and planter box	750	400	25 / 150	484	520	541	578
 ZCA474	Set of 3 shelves and shelf cabinet with drawer (without lock) Painted metal handle	750	400	25 / 405	666	718	713	765
 ZCA478	Set of 2 shelves, planter box and shelf cabinet with drawer (without lock)	750	400	25 / 150 / 405	754	843	786	874





		G1: Band A MFC			G2: Band B MFC	
CODE	DESCRIPTION	WIDTH	DEPTH	HEIGHT	G1 (£)	G2 (£)
 ZCA530	Set of 6 shelves	362	400	25	302	349
 ZCA570	Set of 6 shelves	750	400	25	479	567





G1: Band A MFC Shelves + Boxes		G3: Band B MFC Shelves + Band A MFC Boxes							
G2: Band A MFC Shelves + Band B MFC Boxes		G4: Band B MFC Shelves + Boxes							
	CODE	DESCRIPTION	WIDTH	DEPTH	HEIGHT	G1 (£)	G2 (£)	G3 (£)	G4 (£)
	ZCA531	Set of 4 shelves and open shelf box	362	400	25 / 405	354	385	385	416
	ZCA532	Set of 4 shelves and 1closed shelf box	362	400	25 / 405	380	422	411	453
	ZCA535	Set of 2 shelves, closed and open shelf boxes	362	400	25 / 405	437	510	453	526
	ZCA533	Set of 3 shelves and open shelf box	362	400	25 / 785	359	406	380	427
	ZCA536	Set of shelf, open and closed shelf boxes	362	400	25 / 405 / 785	442	531	448	536
	ZCA534	Set of 5 shelves and planter box	362	400	25 / 150	354	380	396	422
	ZCA537	Set of 4 shelves and 2 planter boxes	362	400	25 / 150	416	468	448	500
	ZCA538	Set of 3 shelves, planter box and closed shelf box	362	400	25 / 150 / 405	442	510	463	531

	CODE	DESCRIPTION	WIDTH	DEPTH	HEIGHT	G1 (£)	G2 (£)	G3 (£)	G4 (£)
	ZCA571	Set of 4 shelves and open shelf box	750	400	25 / 405	531	578	588	635
	ZCA572	Set of 4 shelves and closed shelf box	750	400	25 / 405	588	640	645	697
	ZCA575	Set of 2 shelves, closed and open shelf boxes	750	400	25 / 405	645	744	676	775
	ZCA573	Set of 5 shelves and planter box	750	400	25 / 150	562	598	635	671
	ZCA576	Set of 4 shelves and 2 planter boxes	750	400	25 / 150	650	723	708	780
	ZCA574	Set of 3 shelves and closed shelf box	750	400	25 / 785	619	702	666	749
	ZCA577	Set of 3 shelves, planter box and shelf cabinet with drawer (without lock)	750	400	25 / 150 / 405	832	921	879	968
	ZCA578	Set of 2 shelves, open shelf box and shelf cabinet with drawer (without lock)	750	400	25 / 405	801	900	832	931

		G1: Band A MFC			G2: Band B MFC				
	CODE	DESCRIPTION	WIDTH	DEPTH	HEIGHT	G1 (£)	G2 (£)		
	ZCA630	Set of 7 shelves	362	400	25	349	401		
	ZCA670	Set of 7 shelves	750	400	25	557	661		
		G1: Band A MFC Shelves + Boxes	G3: Band B MFC Shelves + Band A MFC Boxes						
		G2: Band A MFC Shelves + Band B MFC Boxes	G4: Band B MFC Shelves + Boxes						
	CODE	DESCRIPTION	WIDTH	DEPTH	HEIGHT	G1 (£)	G2 (£)	G3 (£)	G4 (£)
	ZCA631	Set of 5 shelves and open shelf box	362	400	25 / 405	401	432	442	474
	ZCA637	Set of 3 shelves and 2 open shelf boxes	362	400	25 / 405	463	526	484	546
	ZCA632	Set of 3 shelves, open and closed shelf box	362	400	25 / 405	489	562	510	583
	ZCA633	Set of 5 shelves and closed shelf box	362	400	25 / 355	427	468	468	510
	ZCA638	Set of 3 shelves and 2 closed shelf boxes	362	400	25 / 405	515	598	536	619
	ZCA634	Set of 4 shelves and open shelf box	362	400	25 / 785	406	453	437	484

	CODE	DESCRIPTION	WIDTH	DEPTH	HEIGHT	G1 (£)	G2 (£)	G3 (£)	G4 (£)
	ZCA635	Set of 2 shelves, open and closed shelf box	362	400	25 / 785	489	578	505	593
	ZCA639	Set of 3 shelves, open shelf box and planter box	362	400	25 / 150 / 785	468	541	489	562
	ZCA636	Set of 5 shelves and 2 planter boxes	362	400	25 / 150	463	515	505	557
	ZCA642	Set of 4 shelves, planter box and closed shelf box	362	400	25 / 150 / 405	489	557	520	588
	ZCA671	Set of 5 shelves and open shelf box	750	400	25 / 405	609	656	682	728
	ZCA672	Set of 3 shelves, open and closed shelf box	750	400	25 / 405	723	822	770	869
	ZCA673	Set of 5 shelves and closed shelf box	750	400	25 / 405	666	718	739	791
	ZCA674	Set of 5 shelves and 2 planter boxes	750	400	25 / 150	728	801	801	874

G1: Band A MFC Shelves + Boxes G2: Band A MFC Shelves + Band B MFC Boxes		G3: Band B MFC Shelves + Band A MFC Boxes G4: Band B MFC Shelves + Boxes							
CODE	DESCRIPTION	WIDTH	DEPTH	HEIGHT	G1 (£)	G2 (£)	G3 (£)	G4 (£)	
 ZCA675	Set of 4 shelves and closed shelf box	750	400	25 / 785	697	780	754	838	
 ZCA676	Set of 2 shelves, open and closed shelf boxes	750	400	25 / 405 / 785	754	884	786	916	
 ZCA677	Set of 3 shelves, 2 planter boxes and shelf cabinet with drawer (without lock)	750	400	25 / 150 / 405	999	1,124	1,046	1,170	
 ZCA678	Set of 3 shelves, open shelf box and shelf cabinet with drawer (without lock)	750	400	25 / 405	879	978	926	1,025	

		G1: Band A MFC			G2: Band B MFC			
CODE	DESCRIPTION	WIDTH	DEPTH	HEIGHT	G1 (£)	G2 (£)	G3 (£)	G4 (£)
 ZCB280	Set of metal frame and 6 shelves for mounting on Choice cabinets (only 800mm width)	800	400	785	494	546		
G1: Band A MFC Shelves + Boxes G2: Band A MFC Shelves + Band B MFC Boxes		G3: Band B MFC Shelves + Band A MFC Boxes G4: Band B MFC Shelves + Boxes						
CODE	DESCRIPTION	WIDTH	DEPTH	HEIGHT	G1 (£)	G2 (£)	G3 (£)	G4 (£)
 ZCB281	Set of metal frame, shelf and planter box	800	400	785	526	562	541	578
 ZCB282	Set of metal frame, 2 shelves and 2 open shelf boxes for mounting on Choice cabinets (only 800mm width)	800	400	785	640	702	656	718
 ZCB283	Set of metal frame, 2 shelves and 2 closed shelf boxes for mounting on Choice cabinets (only 800mm width)	800	400	785	702	780	718	796

	CODE	DESCRIPTION	G1: Band A MFC			G2: Band B MFC		
			WIDTH	DEPTH	HEIGHT	G1 (£)	G2 (£)	
	ZCB380	Set of metal frame and 8 shelves for mounting on Choice cabinets (only 800mm width)	800	400	1165	687	749	

G1: Band A MFC Shelves + Boxes
G2: Band A MFC Shelves + Band B MFC Boxes





G3: Band B MFC Shelves + Band A MFC Boxes
G4: Band B MFC Shelves + Boxes





	CODE	DESCRIPTION	WIDTH	DEPTH	HEIGHT	G1 (£)	G2 (£)	G3 (£)	G4 (£)
	ZCB381	Set of metal frame, 2 shelves and planter box	800	400	1165	656	692	687	723
	ZCB382	Set of metal frame, 5 shelves and open and closed shelf box for mounting on Choice cabinets (only 800mm width)	800	400	1165	770	817	822	869
	ZCB383	Set of metal frame, 2 shelves and 3 open shelf boxes for mounting on Choice cabinets (only 800mm width)	800	400	1165	884	988	900	1,004
	ZCB384	Set of metal frame, 3 shelves, open and closed shelf boxes and planter box for mounting on Choice cabinets (only 800mm width)	800	400	1165	926	1,025	947	1,046
	ZCB385	Set of metal frame, 6 shelves and 2 planter boxes for mounting on Choice cabinets (only 800mm width)	800	400	1165	827	879	879	931





	CODE	DESCRIPTION	G1: Band A MFC			G2: Band B MFC		
			WIDTH	DEPTH	HEIGHT	G1 (£)	G2 (£)	
	ZCB480	Set of metal frame and 10 shelves for mounting on cabinets (only 800mm width)	800	400	1545	843	947	





G1: Band A MFC Shelves + Boxes
G2: Band A MFC Shelves + Band B MFC Boxes



G3: Band B MFC Shelves + Band A MFC Boxes
G4: Band B MFC Shelves + Boxes



	CODE	DESCRIPTION	WIDTH	DEPTH	HEIGHT	G1 (£)	G2 (£)	G3 (£)	G4 (£)
	ZCB481	Set of metal frame, 6 shelves, open and closed shelf boxes for mounting on Choice cabinets (only 800mm width)	800	400	1545	1,020	1,092	1,072	1,144
	ZCB482	Set of metal frame, 5 shelves and 2 open shelf boxes for mounting on Choice cabinets (only 800mm width)	800	400	1545	1,014	1,092	1,066	1,144
	ZCB483	Set of metal frame, 2 shelves and 4 open shelf boxes for mounting on Choice cabinets (only 800mm width)	800	400	1545	1,139	1,264	1,155	1,280
	ZCB484	Set of metal frame, 4 shelves, 2 open shelf boxes and 2 planter boxes for mounting on Choice cabinets (only 800mm width)	800	400	1545	1,144	1,259	1,176	1,290
	ZCB485	Set of metal frame, 7 shelves and 3 planter boxes for mounting on Choice cabinets (only 800mm width)	800	400	1545	1,077	1,155	1,144	1,222



		G1: Band A MFC			G2: Band B MFC				
	CODE	DESCRIPTION	WIDTH	DEPTH	HEIGHT	G1 (£)	G2 (£)		
	ZCC280	Set of metal frame, planter box and plinth	800	400	875	682	734		
	ZCC381	Set of metal frame, planter box, cabinet with drawer (without lock) and plinth Painted metal handle	800	400	1255	1,139	1,228		
		G1: Band A MFC Shelves + Boxes G2: Band A MFC Shelves + Band B MFC Boxes	G3: Band B MFC Shelves + Band A MFC Boxes G4: Band B MFC Shelves + Boxes						
	CODE	DESCRIPTION	WIDTH	DEPTH	HEIGHT	G1 (£)	G2 (£)	G3 (£)	G4 (£)
	ZCC380	Set of metal frame, 2 shelves, planter box and plinth	800	400	1255	874	910	905	942
	ZCC480	Set of metal frame, 3 shelves, planter box and plinth	800	400	1635	1,025	1,061	1,072	1,108
	ZCC481	Set of metal frame, shelf, planter box, cabinet with drawer (without lock) and plinth Painted metal handle	800	400	1635	1,295	1,384	1,311	1,399

	CODE	DESCRIPTION	WIDTH	DEPTH	HEIGHT	RSP (£)
	ZCZ002	PET felt basket	358	130	280	110
	ZCZ003	Set of fixing components for wall (2pcs.)				6
	ZCZ004	Set of connecting components for shelves combination connection (2 pcs.)				21
	ZCZ005	Counterweight for 400mm width metal frame (3pcs.)				42
	ZCZ006	Counterweight for 800mm width metal frame (3pcs.)				84

	CODE	DESCRIPTION	WIDTH	DEPTH	HEIGHT	RSP (£)
	ZCZ001	Metal vertical cable tody for cable management, fixes to metal frame	1245	51	13	21
	ZCZ02L	Metal book-end, L/H	250	160	230	26
	ZCZ02R	Metal book-end, R/H	250	160	230	26
	ZCZ036	Metal planter box	362	405	160	115
	ZCZ076		750	405	160	172
	ZCZ037	Metal screen holder with VESA mount	362	57 (25)*	355	63
	ZCZ077		750	57 (25)*	355	94

	CODE	DESCRIPTION	WIDTH	DEPTH	HEIGHT	RSP (£)
	ZCZ032	PET felt back panel (1 pcs.)	362	22	355	141
	ZCZ072	PET felt back panel (1 pcs.)	750	22	355	156
	ZCZ033	PET felt back panels (3 pcs.)	362	22	355	427
	ZCZ073	PET felt back panels (3 pcs.)	750	22	355	468

		G1: Band A MFC		G2: Band B MFC			
	CODE	DESCRIPTION	WIDTH	DEPTH	HEIGHT	G1 (£)	G2 (£)
	ZCZ030	Back panel (1 pcs.)	362	25	355	73	78
	ZCZ070	Back panel (1 pcs.)	750	25	355	94	99
	ZCZ031	Back panels (3 pcs.)	362	25	355	208	224
	ZCZ071	Back panels (3 pcs.)	750	25	355	266	292

	CODE	DESCRIPTION	WIDTH	DEPTH	HEIGHT	RSP (£)
	ZCZ034	Perforated metal sheet back panel (1 pcs.)	362	20	355	94
	ZCZ074		750	20	355	125
	ZCZ035	Perforated metal sheet back panel (3 pcs.)	362	20	355	276
	ZCZ075		750	20	355	370

Screens & Acoustic

Screens

Acoustic screens

Room dividers

Acoustic panels



Fabric screens

Desktop dividers

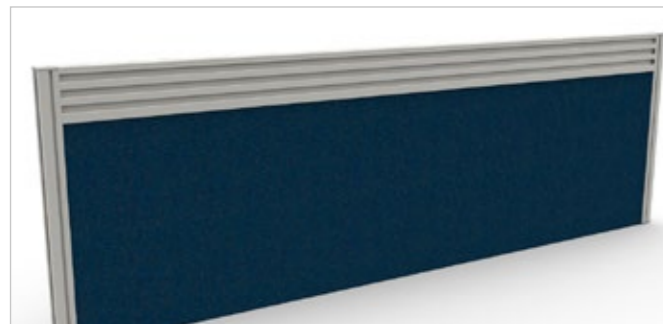
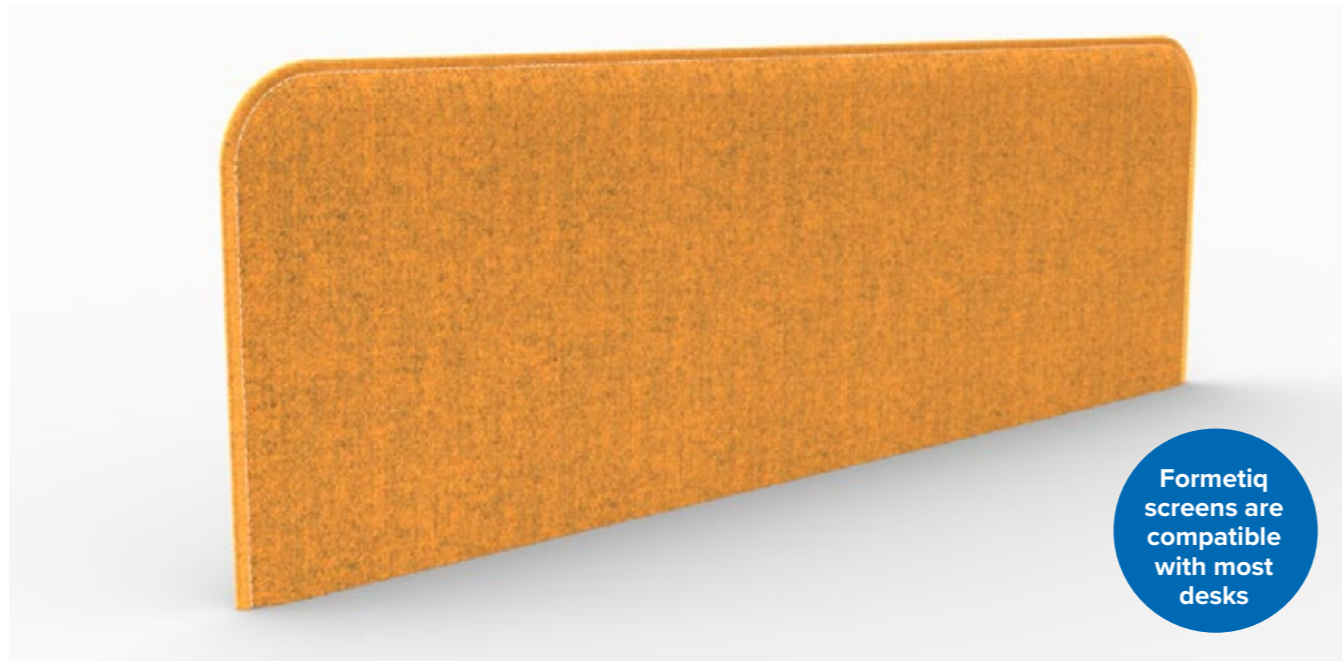

Our wide range of fabric screens can enhance desks in any workspace, adding colour, texture and necessary sound absorption, all manufactured in the UK.

Aluminium frames and PVC edging are available in a choice of White, Grey or Black*.

Technical

Screen height

- When fitted all screens will be aligned 390mm above the desktop.

Brackets

- All prices include brackets. Please supply desk layout plans so we can select correct brackets for your requirements.

Pinnable option

- With the exception of stitched edge, all fabric screens offer a pinnable option, designed for use with pins.

Materials

Fabrics

- Camira Cara
- Camira Lucia
- Camira Era
- Camira Xtreme
- Camira Blazer Lite
- Camira X2
- Camira Aspect
- Camira Quest
- Camira Chateau
- Camira Synergy
- Camira Blazer

Aluminium frame

- Black (BK)*
- White (WH)
- Grey (SV)

Plastic trim

- Black (BK)
- White (WH)
- Grey (SV)

Eco friendly

Blazer Lite†

	CODE	DESCRIPTION	WIDTH	DEPTH	HEIGHT	RSP (£)
	FS/0800-380/ST	Stitched edge spine screen with radius corners	800	25	380	411
	FS/1200-380/ST		1200	25	380	423
	FS/1400-380/ST		1400	25	380	444
	FS/1600-380/ST		1600	25	380	504
	FS/1800-380/ST		1800	25	380	722



	G1: Cara			G2: Lucia / Era			G3: Blazer Lite		
	CODE	DESCRIPTION	WIDTH	DEPTH	HEIGHT	G1 (£)	G2 (£)	G3 (£)	
	FR/0800-380/ST	Fabric edged spine screen with radius corners	800	25	380	228	262	328	
	FR/1200-380/ST		1200	25	380	270	323	421	
	FR/1400-380/ST		1400	25	380	285	346	460	
	FR/1600-380/ST		1600	25	380	328	399	530	
	FR/1800-380/ST		1800	25	380	332	401	531	
	FR/0705-385/ST	Back-to-back desk return screen (Nova)	705	25	385	246	290	367	
	FR/0805-385/ST		805	25	385	246	290	367	
	FR/0785-380/ST	Single desk return screen	785	25	380	228	262	328	
	FR/0800-380/ST-P	Pinnable fabric edged spine screen with radius corners	800	25	380	307	344	411	
	FR/1200-380/ST-P		1200	25	380	378	432	533	
	FR/1400-380/ST-P		1400	25	380	513	575	693	
	FR/1600-380/ST-P		1600	25	380	528	601	734	
	FR/1800-380/ST-P		1800	25	380	531	602	737	
	FR/0785-380/ST-P	Pinnable single desk return screen	785	25	380	307	344	411	

* Black (BK) aluminium not available on 'AP' screens (with plastic top trim)

† Not every fabric in Blazer Lite range is available on FS screens - please see fabrics section at back of price list for details



G1: Cara
G2: Lucia / Era
G3: Xtreme / Blazer Lite / X2 / Aspect / Quest / Chateau
G4: Synergy / Blazer

Black (BK) aluminium not available on 'AP' screens
(with plastic top trim)

	CODE	DESCRIPTION	WIDTH	DEPTH	HEIGHT	G1 (£)	G2 (£)	G3 (£)	G4 (£)
	PV/0800-380/ST	PVC edged fabric spine screen with radius corners	800	25	380	171	200	255	365
	PV/1200-380/ST		1200	25	380	204	245	321	475
	PV/1400-380/ST		1400	25	380	213	260	347	523
	PV/1600-380/ST		1600	25	380	252	305	403	601
	PV/1800-380/ST		1800	25	380	264	323	432	652
	PV/0785-380/ST	Single desk return screen	785	25	380	171	200	255	365
	PV/0800-380/ST-P	Pinnable PVC edged fabric spine screen with radius corners	800	25	380	241	271	327	440
	PV/1200-380/ST-P		1200	25	380	297	339	417	576
	PV/1400-380/ST-P		1400	25	380	361	409	499	680
	PV/1600-380/ST-P		1600	25	380	427	480	581	785
	PV/1800-380/ST-P		1800	25	380	438	499	611	836
	PV/0785-380/ST-P	Pinnable single desk return screen	785	25	380	241	271	327	440
	AP/0800-380/ST	Fabric spine screen with aluminium end posts and plastic top trim	800	30	380	192	222	273	377
	AP/1200-380/ST		1200	30	380	230	272	347	501
	AP/1400-380/ST		1400	30	380	240	286	373	533
	AP/1600-380/ST		1600	30	380	278	330	428	626
	AP/1800-380/ST		1800	30	380	299	357	466	685
	AP/0705-385/ST	Back-to-back desk return screen (Nova)	705	30	385	200	230	314	391
	AP/0805-385/ST		805	30	385	200	230	319	396
	AP/0785-380/ST	Single desk return screen	785	30	380	192	222	273	377
	AP/0800-380/ST-P	Pinnable fabric spine screen with aluminium end posts and plastic top trim	800	30	380	271	299	352	457
	AP/1200-380/ST-P		1200	30	380	334	376	454	612
	AP/1400-380/ST-P		1400	30	380	451	500	589	770
	AP/1600-380/ST-P		1600	30	380	461	515	616	820
	AP/1800-380/ST-P		1800	30	380	482	542	654	880
	AP/0785-380/ST-P	Pinnable single desk return screen	785	30	380	271	299	352	457

	CODE	DESCRIPTION	WIDTH	DEPTH	HEIGHT	RSP (£)
	SA-LINK-KIT	Linking kit	-	-	-	26

G1: Cara
G2: Lucia / Era
G3: Xtreme / Blazer Lite / X2 / Aspect / Quest / Chateau
G4: Synergy / Blazer

	CODE	DESCRIPTION	WIDTH	DEPTH	HEIGHT	G1 (£)	G2 (£)	G3 (£)	G4 (£)
	AL/0800-380/TB1	Fabric spine screen with aluminium end posts and single tool rail	800	30	380	209	238	292	403
	AL/1200-380/TB1		1200	30	380	247	288	363	517
	AL/1400-380/TB1		1400	30	380	263	311	396	572
	AL/1600-380/TB1		1600	30	380	303	356	454	652
	AL/1800-380/TB1		1800	30	380	325	383	491	678
	AL/0705-385/TB1	Back-to-back desk return screen (Nova)	705	30	385	218	249	310	432
	AL/0805-385/TB1		805	30	385	218	249	288	402
	AL/0785-380/TB1	Single desk return screen	785	30	380	209	238	292	403
	AL/0800-380/TB1-P	Pinnable fabric spine screen with aluminium end posts and single tool rail	800	30	380	289	319	376	488
	AL/1200-380/TB1-P		1200	30	380	355	396	475	633
	AL/1400-380/TB1-P		1400	30	380	355	396	475	633
	AL/1600-380/TB1-P		1600	30	380	548	602	703	907
	AL/1800-380/TB1-P		1800	30	380	510	569	680	908
	AL/0785-380/TB1-P	Pinnable single desk return screen	785	30	380	289	319	376	488
	AL/0800-380/TB3	Fabric spine screen with aluminium end posts and triple tool rail	800	30	380	240	269	324	433
	AL/1200-380/TB3		1200	30	380	286	328	404	558
	AL/1400-380/TB3		1400	30	380	326	373	460	636
	AL/1600-380/TB3		1600	30	380	366	418	516	714
	AL/1800-380/TB3		1800	30	380	416	475	582	803
	AL/0785-380/TB3	Single desk return screen	785	30	380	240	269	324	433
	AL/0800-380/TB3-P	Pinnable fabric spine screen with aluminium end posts and triple tool rail	800	30	380	319	348	404	517
	AL/1200-380/TB3-P		1200	30	380	398	440	519	678
	AL/1400-380/TB3-P		1400	30	380	537	585	674	855
	AL/1600-380/TB3-P		1600	30	380	548	602	703	907
	AL/1800-380/TB3-P		1800	30	380	600	660	772	998
	AL/0785-380/TB3-P	Pinnable single desk return screen	785	30	380	319	348	404	517

See toolrail accessories on page 229

Perspex® screens

Desktop dividers / Modesty panels

Formetiq screens are compatible with all desks

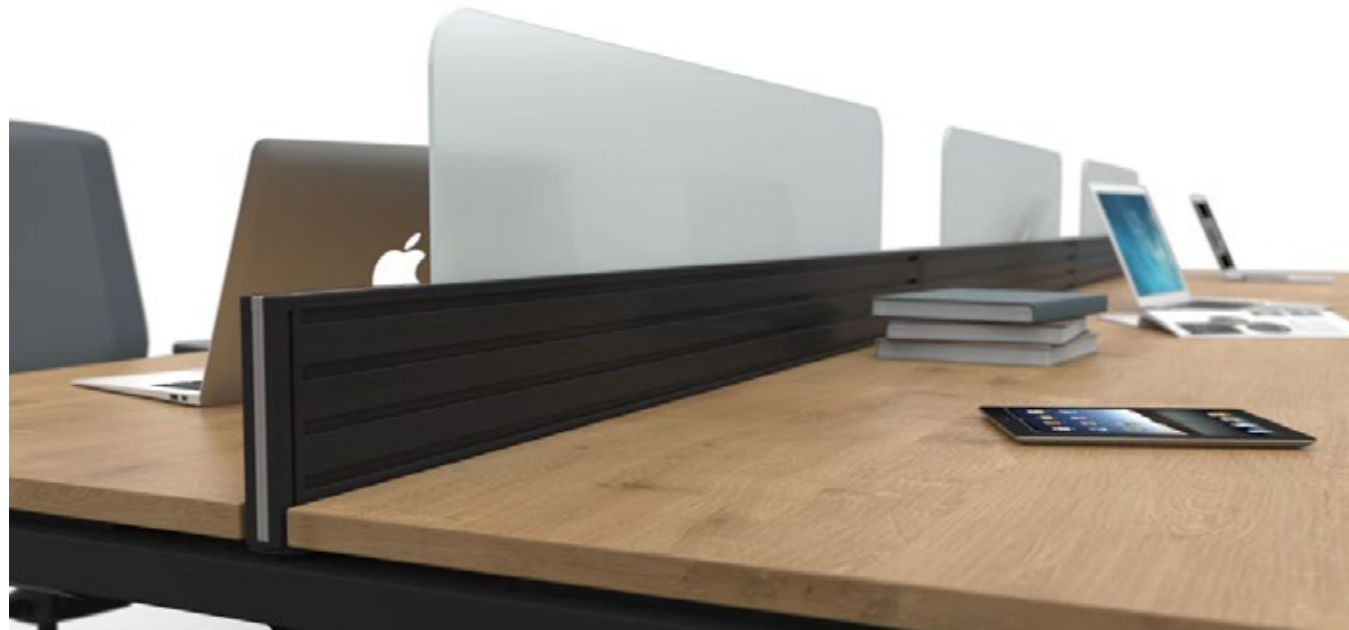

Choose from our range of Perspex® screens in various frosted colours.

Technical

Minimum order

- Colours have a minimum order of 5 screens.

Brackets

- Fixing brackets are included. Please supply desk layout plans so we can select correct brackets for your requirements.

Materials

Perspex® Frost

- Aurora Violet (S2 7T58)
- Chilli Red (S2 4T50)
- Electric Blue (S2 7T69)
- Glacier Green (S2 6T21)
- Polar White (S2 030)
- Slate Grey (S2 9T23)

Aluminium

- Black (BK)
- White (WH)
- Grey (SV)

	CODE	DESCRIPTION	WIDTH	DEPTH	HEIGHT	RSP (£)
	UPS/1200-380/ST	Perspex® screen for W1200mm desk	1100	5	380	315
	UPS/1400-380/ST	Perspex® screen for W1400mm desk	1300	5	380	337
	UPS/1600-380/ST	Perspex® screen for W1600mm desk	1500	5	380	387
	UPS/1800-380/ST	Perspex® screen for W1800mm desk	1700	5	380	422
	VT/1200-380/TB4	Aluminium four slot tool rail with Perspex® screen	1200	30	380	490
	VT/1400-380/TB4		1400	30	380	545
	VT/1600-380/TB4		1600	30	380	582
	VT/1800-380/TB4		1800	30	380	643
	VT/1200-165/TB4	Aluminium four slot tool rail only	1200	30	165	327
	VT/1400-165/TB4		1400	30	165	329
	VT/1600-165/TB4		1600	30	165	330
	VT/1800-165/TB4		1800	30	165	406
	SA-A4LT	A4 Letter Tray	-	-	-	36
	SA-A3LT	A3 Letter Tray	-	-	-	46
	SA-LTSP-A4	A4 Letter Tray Stacking Panel	-	-	-	54
	SA-A4WB	A4 Whiteboard	-	-	-	50
	SA-A3WB	A3 Whiteboard	-	-	-	60
	SA-PEPT	Pencil pot	-	-	-	30
	SA-NHLD	Name Holder	-	-	-	27
	SA-TRPT	Trinket Pot	-	-	-	29

Round PET

Acoustic desk screens

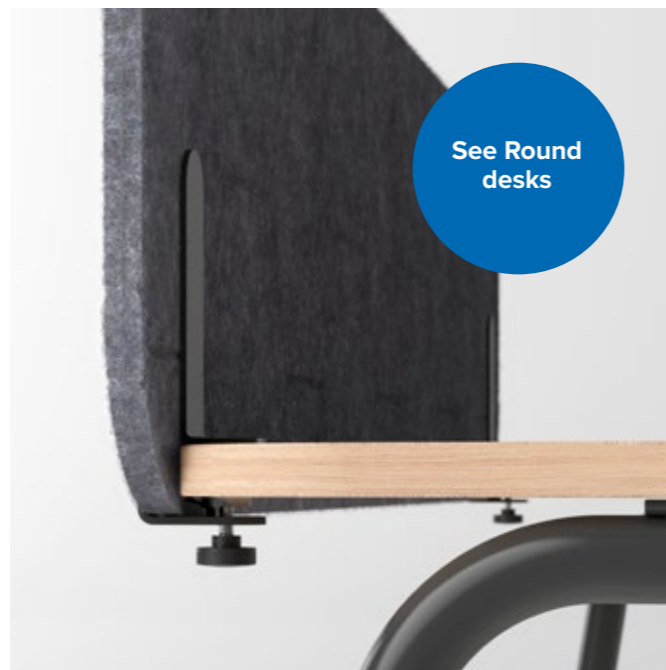

See Round desks

Part of the Round desking and storage system these vibrant screens are suitable for Round single and bench desks, but designed to work with both fixed and sliding desktops.

Available in different widths and heights and various colours and patterns (with rounded lines or honeycomb motif), they are also lightweight, which lowers the desk load and makes them easy to handle. The metal bracket design makes them quick and easy to assemble.

Round acoustic desk screens are made from PET felt which although it feels like natural wool is actually made from 50% recycled plastic, a sustainable material which possesses excellent sound absorption properties.

PET felt is soft and light, yet strong and durable. It meets applicable fire safety requirements and can be easily cleaned and disinfected.

Range

Plain (ZA0)

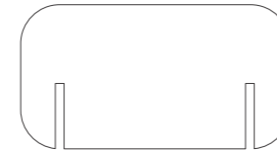

Fixed desktops

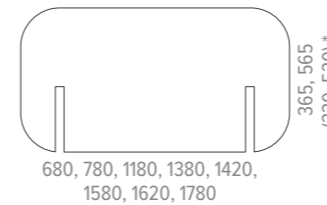

Brackets for fixed desktops (front/side)

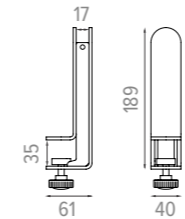

Hex pattern (ZA1)

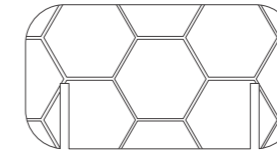

Mobile screens

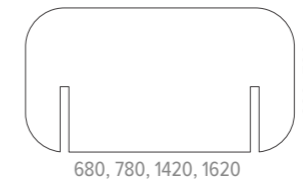

Feet for mobile screens

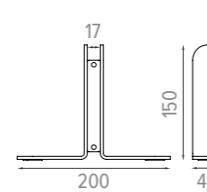

Flo pattern (ZA2)

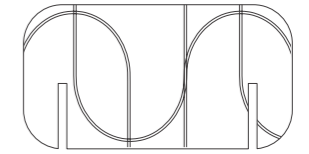

Sliding desktops

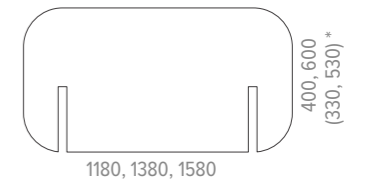

Brackets for sliding desktops (front/side)

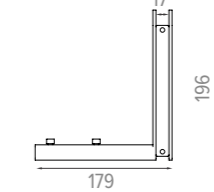

Brackets for sliding desktops (bench)

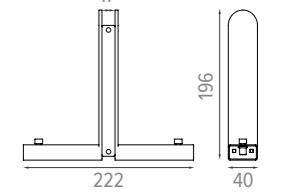

Technical

Screen composition

- Two separate 9mm PET boards glued into one solid 18mm screen, R100mm rounded corners

Metal brackets for fixed desktops

- Welded, 4mm sheet powder coated metal clamping brackets
- Galvanised clamping pad
- Plastic knob with metal screw
- Designed to be attached to fixed desktops (17-27mm thickness)

Metal feet for mobile screens

- Welded, 4mm sheet powder coated metal feet, W200mm
- Glued anti-friction pads
- Feet designed for screen mobility (stand anywhere on flat surface)

Metal brackets for sliding desktops

- Welded, 4mm sheet powder coated metal brackets
- Designed to be screwed to the sliding desk metal beam

Materials

PET Felt* ♻️

- Grey (B18)
- Sand (B19)
- Green (B44)
- Dark Blue (B50)
- Blue (B51)
- Coral Pink (B56)
- Chestnut (B53)
- Dark Pink (B52)
- Dark Grey (B54)
- Lime (B55)
- Light Grey (B58)
- Light Beige (B57)

G1 Pattern

Plain (ZA0)

G2 Patterns









Hex (ZA1)
Flo (ZA2)

Metal

Anthracite (T1)
Black (A)
Grey (M)
White (E)

♻️ Eco friendly

* See PET felt colour swatches on page 464

	CODE	DESCRIPTION	WIDTH	DEPTH	HEIGHT	G1 (£)	G2 (£)
	DPA07A	Screen for 700 mm length desk	680	18	365	241	272
	DPA08A	Screen for 800 mm length desk	780	18	365	254	310
	DPA12A	Screen for 1200 mm length desk	1180	18	365	334	408
	DPA14A	Screen for 1400 mm length desk	1380	18	365	422	497
	DPA16A	Screen for 1600 mm length desk	1580	18	365	436	525
	DPA18A	Screen for 1800 mm length desk	1780	18	365	452	544
	DPA07B	Screen for 700 mm length desk	680	18	565	297	327
	DPA08B	Screen for 800 mm length desk	780	18	565	480	548
	DPA12B	Screen for 1200 mm length desk	1180	18	565	412	512
	DPA14B	Screen for 1400 mm length desk	1380	18	565	552	646
	DPA16B	Screen for 1600 mm length desk	1580	18	565	577	689
	DPA18B	Screen for 1800 mm length desk	1780	18	565	603	734
	DPA07C	Central screen for 700 mm length desk (mobile)	680	18	330	223	260
	DPA08C	Central screen for 800 mm length desk (mobile)	780	18	330	236	292
	DPA14C	Central screen for 1440 mm length desk (mobile)	1420	18	330	403	472
	DPA16C	Central screen for 1640 mm length desk (mobile)	1620	18	330	415	503
	DPA07D	Central screen for 700 mm length desk (mobile)	680	18	530	276	315
	DPA08D	Central screen for 800 mm length desk (mobile)	780	18	530	304	360
	DPA14D	Central screen for 1440 mm length desk (mobile)	1420	18	530	556	642
	DPA16D	Central screen for 1640 mm length desk (mobile)	1620	18	530	574	691

	CODE	DESCRIPTION	WIDTH	DEPTH	HEIGHT	G1 (£)	G2 (£)
	DPA14E	Screen for 1440 mm length desk (double benches only)	1420	18	365	421	489
	DPA16E	Screen for 1640 mm length desk (double benches only)	1620	18	365	433	527
	DPA12F	Screen for 1200 mm length desk (double benches only)	1180	18	365	347	421
	DPA14F	Screen for 1400 mm length desk (double benches only)	1380	18	365	435	504
	DPA16F	Screen for 1600 mm length desk (double benches only)	1580	18	365	451	538
	DPA18F	Screen for 1800 mm length desk (double benches only)	1780	18	365	458	558
	DPA14G	Screen for 1440 mm length desk (double benches only)	1420	18	565	576	668
	DPA16G	Screen for 1640 mm length desk (double benches only)	1620	18	565	564	695
	DPA12H	Screen for 1200 mm length desk (double benches only)	1180	18	565	427	526
	DPA14H	Screen for 1400 mm length desk (double benches only)	1380	18	565	565	659
	DPA16H	Screen for 1600 mm length desk (double benches only)	1580	18	565	590	701
	DPA18H	Screen for 1800 mm length desk (double benches only)	1780	18	565	611	741
	DPA12J	Screen for 1200 mm length desk with sliding desktop	1180	18	400	308	396
	DPA14J	Screen for 1400 mm length desk with sliding desktop	1380	18	400	414	494
	DPA16J	Screen for 1600 mm length desk with sliding desktop	1580	18	400	423	517
	DPA12L	Screen for 1200 mm length desk bench with sliding desktop	1180	18	400	310	398
	DPA14L	Screen for 1400 mm length desk bench with sliding desktop	1380	18	400	421	503
	DPA16L	Screen for 1600 mm length desk bench with sliding desktop	1580	18	400	431	525
	DPA12M	Screen for 1200 mm length desk with sliding desktop	1180	18	600	397	509
	DPA14M	Screen for 1400 mm length desk with sliding desktop	1380	18	600	544	638
	DPA16M	Screen for 1600 mm length desk with sliding desktop	1580	18	600	556	687
	DPA12P	Screen for 1200 mm length desk bench with sliding desktop (double benches only)	1180	18	600	389	507
	DPA14P	Screen for 1400 mm length desk bench with sliding desktop (double benches only)	1380	18	600	551	646
	DPA16P	Screen for 1600 mm length desk bench with sliding desktop (double benches only)	1580	18	600	563	694

Nova

Fabric / Plexiglas® screens & modesty panels



Nova desktop divider screens are designed to work with Nova desking but also work with other desks from the Narbutas range.

Choose from fabric screens available in a range of fabric options or Plexiglas® screens and modesty panels available in a variety of different colours.

Nova desk screens are also compatible with Nova Wood desks.

For Nova Wood 2-desk and 4-desk benches with HPL top:
DNK142, DNK143, DNK146, DNK151, DNK162, DNK163, DNK166, DNK171, DNK182, DNK183, DNK186, DNK189.

DNK08C is not compatible with NOVA O single row 2-desk benches.

Range

Fabric

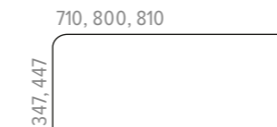
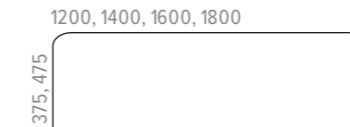
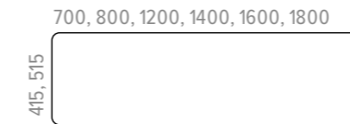

Nova U Slide (fabric)

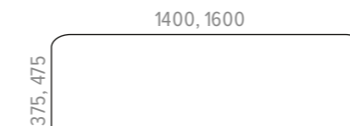
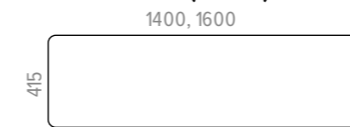

Plexiglas®

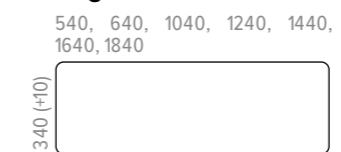

Technical

Fabric

- 16mm chipboard, covered with VB2240 3mm foam, upholstered with fabric

Plexiglas® (acrylic)

- 100% recyclable matt and long-lasting Plexiglas® surface (resistant to scratching and fingerprints)
- Not suitable for NOVA U Slide (with sliding top)

Fixing

- On NOVA U, A, O & H leg desks screens are fixed to the desktop with wood screws
- For NOVA U Slide desks screens are fixed with bolts to metal frame

Materials

G1 Fabric

Berta
Bondai

G2 Fabric*

Camira Lucia

G3 Fabric*

Velito Presto
Step/Step Melange
Camira Synergy

G1 Plexiglas®

White (R01)









G2 Plexiglas®







Orange (R03)
Ice Blue (R06)
Light Green (R07)
Cherry (R08)
Brown (R09)



Metal brackets

Anthracite (T1)
Black (A)
Grey (M)
White (E)

Eco friendly

	CODE	DESCRIPTION	WIDTH	DEPTH	HEIGHT	G1 (£)	G2 (£)	G3 (£)
	DNK070	Fabric end return screen single depth	700	22	415 (350)	88	182	208
	DNK080		800	22	415 (350)	87	181	207
	DNK120	Fabric spine screen for single desks	1200	22	415 (350)	153	304	336
	DNK140		1400	22	415 (350)	156	321	364
	DNK160		1600	22	415 (350)	184	367	411
	DNK180		1800	22	415 (350)	199	400	451
	DNK071	Fabric end return screen single depth	700	22	515 (450)	96	184	210
	DNK081		800	22	515 (450)	102	202	221
	DNK121	Fabric spine screen for single desks	1200	22	515 (450)	159	309	341
	DNK141		1400	22	515 (450)	166	330	370
	DNK161		1600	22	515 (450)	189	372	429
	DNK181		1800	22	515 (450)	217	426	475
	DNK122	Fabric spine screen for back-to-back bench desks	1200	22	375 (350)	142	281	319
	DNK142		1400	22	375 (350)	163	327	364
	DNK162		1600	22	375 (350)	172	360	411
	DNK182		1800	22	375 (350)	199	400	451
	DNK123		1200	22	475 (450)	155	301	331
	DNK143		1400	22	475 (450)	166	337	375
	DNK163		1600	22	475 (450)	189	372	428
	DNK183		1800	22	475 (450)	204	418	462
	DNK077	Fabric centre return screen for D700mm back-to-back bench desks	710	22	347 (350)	166	174	187
	DNK078		710	22	447 (450)	174	199	212
	DNK087	Fabric centre return screen for D800mm back-to-back bench desks	810	22	347 (350)	176	227	245
	DNK088		810	22	447 (450)	184	241	266
	DNK08A	Fabric centre return screen for D800mm side-by-side bench desks	800	22	347 (350)	121	172	184
	DNK08B		800	22	447 (450)	122	174	198

	CODE	DESCRIPTION	WIDTH	DEPTH	HEIGHT	G1 (£)	G2 (£)	G3 (£)
	DNK12A	Set of fabric screens for bank of 4 back-to-back bench desks	1200/710	22	375/347 (350)	615	909	1,010
	DNK14A		1400/710	22	375/347 (350)	650	1,002	1,103
	DNK16A		1600/710	22	375/347 (350)	667	1,063	1,189
	DNK18A		1800/710	22	375/347 (350)	728	1,144	1,268
	DNK12B		1200/710	22	475/447 (450)	650	997	1,084
	DNK14B		1400/710	22	475/447 (450)	672	1,069	1,168
	DNK16B		1600/710	22	475/447 (450)	721	1,142	1,274
	DNK18B		1800/710	22	475/447 (450)	745	1,224	1,338
	DNK130		1200/810	22	375/347 (350)	638	1,016	1,129
	DNK152		1400/810	22	375/347 (350)	679	1,108	1,221
	DNK177		1600/810	22	375/347 (350)	690	1,168	1,300
	DNK190		1800/810	22	375/347 (350)	751	1,250	1,383
	DNK131		1200/810	22	475/447 (450)	682	1,077	1,204
	DNK153		1400/810	22	475/447 (450)	696	1,151	1,289
	DNK178		1600/810	22	475/447 (450)	745	1,224	1,388
	DNK191		1800/810	22	475/447 (450)	777	1,307	1,450
	DNK14E	Fabric spine screen for single desks with sliding top	1400	20	415 (300)	176	341	378
	DNK16E		1600	20	415 (300)	198	375	426
	DNK14F	Fabric spine screen for back-to-back bench desks with sliding tops	1400	20	375 (350)	172	334	373
	DNK16F		1600	20	375 (350)	180	370	412
	DNK14G		1400	20	475 (450)	175	345	382
	DNK16G		1600	20	475 (450)	196	378	434

	CODE	DESCRIPTION	WIDTH	DEPTH	HEIGHT	G1 (£)	G2 (£)	
	DNK074	Plexiglas® end return screen for desks with D700mm tops		540	6	340 (350)	170	251
	DNK084	Plexiglas® end return screen for desks with D800mm tops		640	6	340 (350)	202	297
	DNK124	Plexiglas® spine screen for single desks		1040	6	340 (350)	334	492
	DNK144			1240	6	340 (350)	385	576
	DNK164			1440	6	340 (350)	437	664
	DNK184			1640	6	340 (350)	494	733
	DNK204			1840	6	340 (350)	541	819
	DNK129	Plexiglas® spine screen for back-to-back bench desks		1040	6	340 (350)	353	517
	DNK151			1240	6	340 (350)	404	593
	DNK171			1440	6	340 (350)	455	683
	DNK189			1640	6	340 (350)	512	758

Top 530 & Desk 760

Acoustic desktop screens

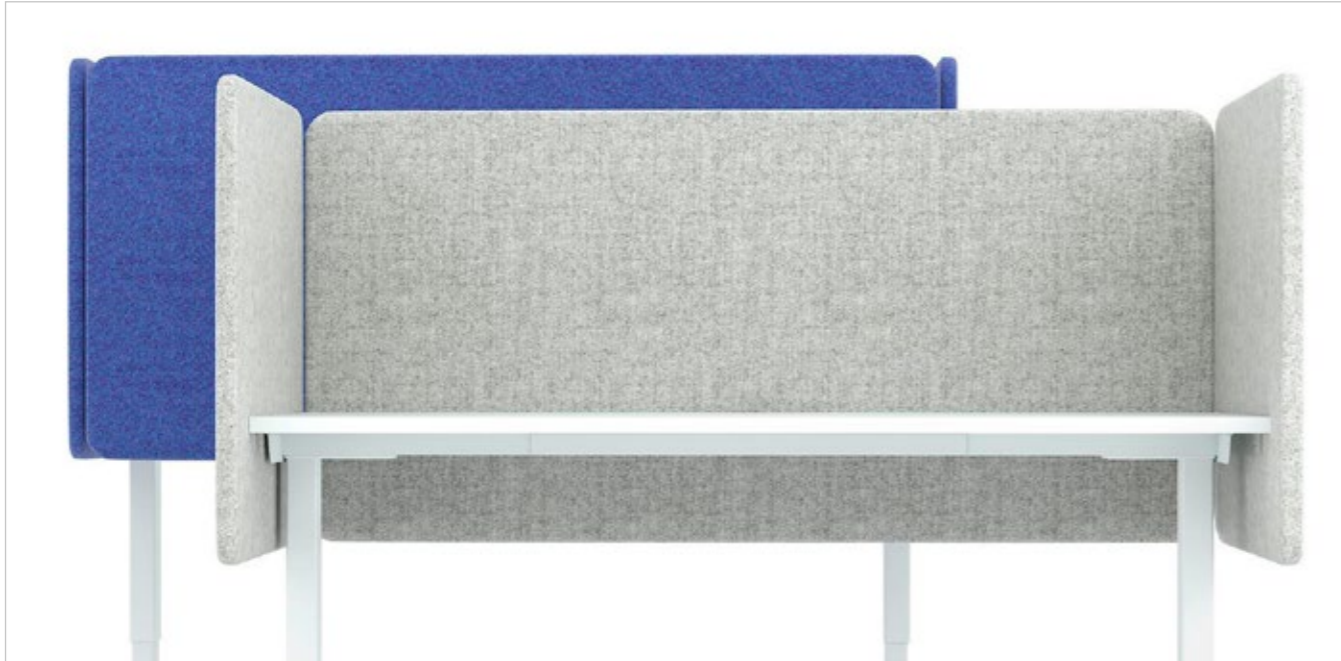

Acoustic screens for stand alone height adjustable and back to back desks.

Our acoustic screens are filled with noise reducing material and covered in natural wool or polyester fabric. They deliver improved visual and audio protection, providing more privacy without isolating employees from each other, separating workspaces and improving your concentration.

Acoustic desk screens give you privacy at work and reduces noise from the surrounding environment. This helps to concentrate on your work, though does not separate employees and allows them to communicate easily. Also suitable for bench desks.

The acoustic screen system Desk 760 effectively shields you from the busy world, but also leaves an opportunity to communicate with other colleagues without boundaries. This is an excellent choice for those who want to distance themselves from distractions.

Range

Top 530

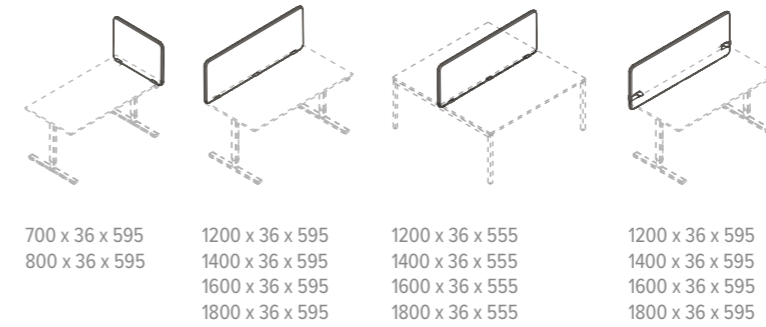

700 x 36 x 595	1200 x 36 x 595	1200 x 36 x 555	1200 x 36 x 595
800 x 36 x 595	1400 x 36 x 595	1400 x 36 x 555	1400 x 36 x 595
	1600 x 36 x 595	1600 x 36 x 555	1600 x 36 x 595
	1800 x 36 x 595	1800 x 36 x 555	1800 x 36 x 595

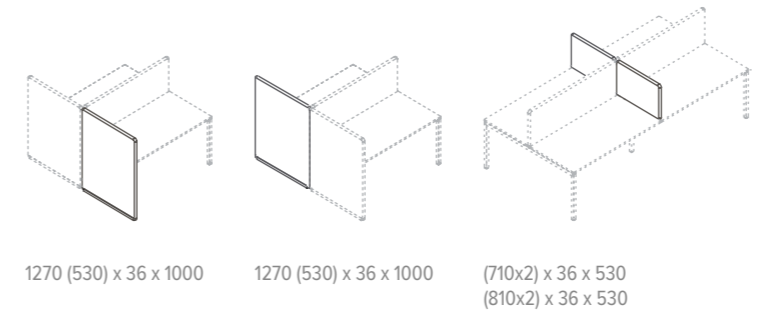

1270 (530) x 36 x 1000	1270 (530) x 36 x 1000	(710x2) x 36 x 530
		(810x2) x 36 x 530

Desk 760

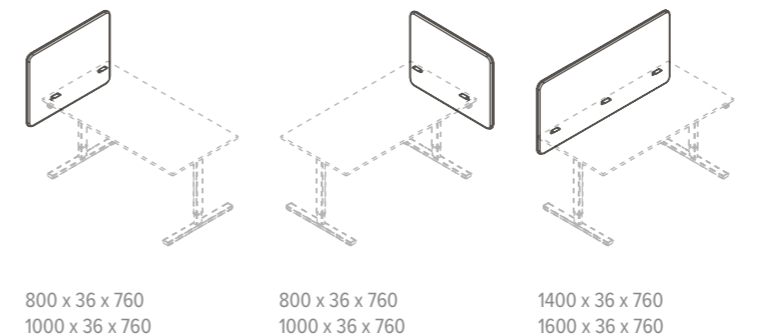

800 x 36 x 760	800 x 36 x 760	1400 x 36 x 760
1000 x 36 x 760	1000 x 36 x 760	1600 x 36 x 760

Materials

G1 Fabric

Berta

G2 Fabric*

Camira Lucia 

G3 Fabric*

Velito Presto

Step/Step Melange

Camira Synergy

Metal brackets

Anthracite (T1)

Black (A)

Grey (M)

White (E)

 Eco friendly

Technical

Composition

- 16mm chipboard, covered with 10mm acoustic foam, upholstered with fabric

Fixed height fittings









- Fixed to the desktop with 2 metal brackets
- 1600-1800 mm screen with 3 metal brackets







Height-adjustable fittings

- Screens can be raised / lowered to the desired height, only two screws must be tightened

Desk760 Fittings

- 1000-1400 mm screen with 2 metal brackets
- 1600-1800 mm screen with 3 metal brackets

	CODE	DESCRIPTION	WIDTH	DEPTH	HEIGHT	G1 (£)	G2 (£)	G3 (£)
	ATK070	Side screen for D700mm desks <i>Compatible with Nova U, Nova H, Nova A, Nova O, Nova Wood (MFC)</i>	700	36	595 (530)	154	186	223
	ATK080	Side screen for D800mm desks <i>Compatible with Nova U, Nova H, Nova A, Nova O, Nova Wood (MFC)</i>	800	36	595 (530)	202	215	259
	ATP120	Spine screen for single desks <i>Compatible with Nova U, Nova H, Nova A, Nova O, Nova Wood (MFC)</i>	1200	36	595 (530)	290	308	403
	ATP140		1400	36	595 (530)	300	356	425
	ATP160		1600	36	595 (530)	326	402	439
	ATP180		1800	36	595 (530)	375	537	550
	ATV120	Spine screen for back-to-back bench desks <i>Compatible with Nova U, Nova A, Nova O, Nova Wood (MFC and HPL)</i>	1200	36	555 (530)	284	353	397
	ATV140		1400	36	555 (530)	292	355	411
	ATV160		1600	36	555 (530)	322	415	429
	ATV180		1800	36	555 (530)	359	478	540
	ATS070	Set of 2 centre return screens for bank of 4 back-to-back bench desks <i>Compatible with Nova U, Nova A, Nova O, Nova Wood (MFC)</i>	710	36	530	396	457	507
	ATS080	Set of 2 bench screens for W800mm desks <i>Compatible with Nova U, Nova A, Nova O, Nova Wood (MFC)</i>	810	36	530	471	508	602
	ATL100	L/ floor standing end return screen <i>Compatible with Nova U, Nova H, Nova A, Nova O, Nova Wood (MFC)</i>	1000	36	1270 (530)	569	634	714
	ATR100	R/ floor standing end return screen <i>Compatible with Nova U, Nova H, Nova A, Nova O, Nova Wood (MFC)</i>	1000	36	1270 (530)	569	634	714
	ATP122	Spine screen for sit stand desks with height adjustable fittings <i>Compatible with Nova A</i>	1200	36	595 (500)	343	368	455
	ATP142		1400	36	595 (500)	377	415	489
	ATP162		1600	36	595 (500)	382	427	502
	ATP182		1800	36	595 (500)	423	592	604
	ATK071	End return screen for single desk	700	36	595 (530)	161	192	228
	ATK081		800	36	595 (530)	210	221	265
	ATP121	Spine screen for single desks <i>Compatible with Nova U, Nova H, Nova A, Nova O, Air, Optima C, Optima Plus</i>	1200	36	595 (530)	290	308	403
	ATP141		1400	36	595 (530)	306	361	431
	ATP161		1600	36	595 (530)	327	409	447
	ATP181		1800	36	595 (530)	382	543	557

	CODE	DESCRIPTION	WIDTH	DEPTH	HEIGHT	G1 (£)	G2 (£)	G3 (£)
	ADK080	Return screen for D800mm desk <i>Compatible with single desk: Motion, Round Rectangular, Nova Wood MFC, Nova U / A / O, bench desk: Round (only ADK080), Nova Wood MFC, Nova U / A / O</i>	800	36	760 (530)	233	276	394
	ADK100	L/ end return screen for D800mm desk <i>Compatible with single desk: Motion, Round Rectangular, Nova Wood MFC, Nova U / A / O, bench desk: Round (only ADK080), Nova Wood MFC, Nova U / A / O</i>	1000	36	760 (530)	322	354	456
	ADK101	R/ end return screen for D800mm desk <i>Compatible with single desk: Motion, Round Rectangular, Nova Wood MFC, Nova U / A / O, bench desk: Round (only ADK080), Nova Wood MFC, Nova U / A / O</i>	1000	36	760 (530)	322	354	456
	ADP120	Spine screen for single desks <i>Compatible with single desk: Motion, Round Rectangular, Nova Wood MFC, Nova U / A / O</i>	1200	36	760 (530)	297	367	507
	ADP140		1400	36	760 (530)	379	494	540
	ADP160		1600	36	760 (530)	422	512	563
	ADP180		1800	36	760 (530)	505	652	966
	ADK081	<i>Compatible with single desk: Motion, Round Rectangular, Nova Wood MFC, Nova U / A / O, Air (only ADK102, ADK103), bench desk: Round (only ADK081), Nova Wood MFC, Nova U / A / O, Air (only ADK102, ADK103)</i>	800	36	760 (530)	239	281	400
	ADK102	L/ end return screen for D800mm desk <i>Compatible with single desk: Motion, Round Rectangular, Nova Wood MFC, Nova U / A / O, Air (only ADK102, ADK103), bench desk: Round (only ADK081), Nova Wood MFC, Nova U / A / O, Air (only ADK102, ADK103)</i>	1000	36	760 (530)	328	360	463
	ADK103	R/ end return screen for D800mm desk <i>Compatible with single desk: Motion, Round Rectangular, Nova Wood MFC, Nova U / A / O, Air (only ADK102, ADK103), bench desk: Round (only ADK081), Nova Wood MFC, Nova U / A / O, Air (only ADK102, ADK103)</i>	1000	36	760 (530)	328	360	463
	ADP121	Spine screen for single desks <i>Compatible with single desk: Motion, Round Rectangular, Nova Wood MFC, Nova, Air, Optima C & Optima Plus</i>	1200	36	760 (530)	297	373	513
	ADP141		1400	36	760 (530)	385	502	540
	ADP161		1600	36	760 (530)	430	520	571
	ADP181		1800	36	760 (530)	512	653	973

Optima

Fabric desk screens



Designed to fit Optima desking range

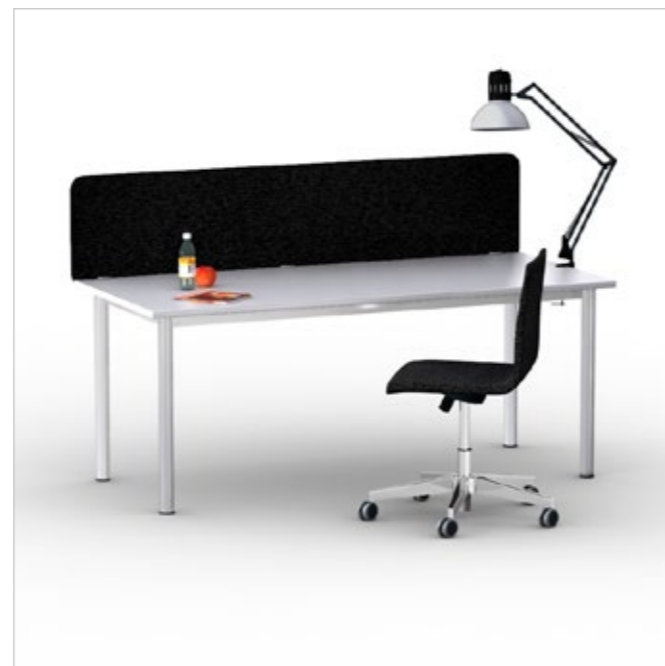
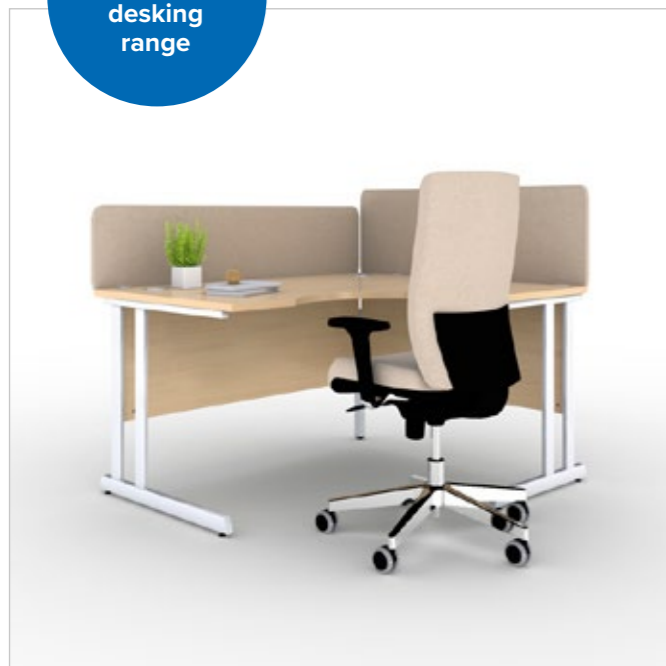

Optima screens are designed to work with and complement the Optima desking range with desk spine screens and returns available.

Choose from rounded corners, in 2 different heights, to give a softer contemporary feel to your workspace. Optima screens offer a large choice of fabric options.

Optima desk screens are compatible with Optima Plus and Optima C desks.

Range

Rounded fabric screens

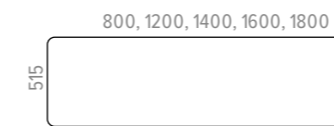
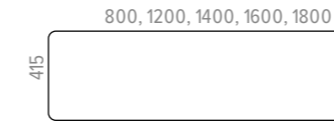

Technical

SCREENS WITH RADIUSED CORNERS

Screen composition

- 16mm chipboard, coated with 3mm foam, upholstered with fabric

Fixing

- Screens fixing with 2 or 3 metal brackets (1200-1600 mm – 2 brackets, 1800mm – 3 brackets)
- Brackets made of 5mm metal sheet
- Thickness of desktops for the brackets can vary 18-28 mm

Materials

G1 Fabric

- Berta
- Bondai

G2 Fabric*

- Camira Lucia 

G3 Fabric*











- Velito Presto
- Step/Step Melange
- Camira Synergy

Metal brackets

- Black (A)
- Grey (M)
- White (E)

 Eco friendly

* Not every fabric in Camira ranges is available on Narbutas products - please see fabrics section at back of price list for details

	CODE	DESCRIPTION	WIDTH	DEPTH	HEIGHT	G1 (£)	G2 (£)	G3 (£)
	DTK080	Return screen	800	22	415 (375)	127	204	219
	DTK081		800	22	515 (475)	140	216	236
	DTK120	Spine screen	1200	22	415 (375)	171	293	319
	DTK122		1200	22	515 (475)	175	298	323
	DTK140		1400	22	415 (375)	178	311	342
	DTK143		1400	22	515 (475)	188	321	351
	DTK160		1600	22	415 (375)	197	340	380
	DTK163		1600	22	515 (475)	200	349	395
	DTK180		1800	22	415 (375)	245	408	450
	DTK181		1800	22	515 (475)	259	428	464

Modus

Double sided fabric desktop screens

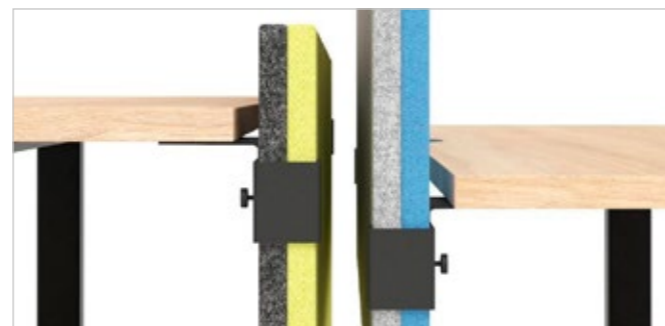
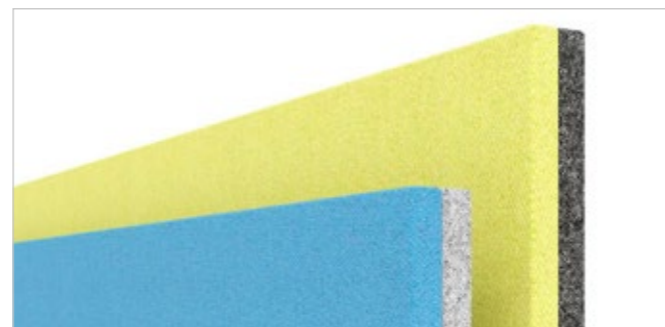

Height adjustable or fixed height Modus acoustic desk screens offer both privacy and sound absorption sheltering users from general office noise.

Modus acoustic desk screens are double-sided allowing you to choose a combination of two different colours** - an easy way to create your own individual workspace whilst still relating to your corporate office interior style

These desk screens can be combined with Modus or Modus Light acoustic panels which can be arranged to ensure both visual and acoustic comfort.

Modus double sided Class D desktop screens (APK120/APK140/APK160/APK180) are also compatible with Active, single Motion desks, single Easy desks, One, Nova A and T-Easy desks.

Modus double sided Class C desktop screens are only compatible with Motion bench desks.

Technical

Screen composition (42 mm)

- 15x40mm plywood frame
- Central 10mm polystyrene foam layer
- Second HR3030 10mm foam layer on both sides
- Third VB2240 3mm foam layer on both sides
- Dowel pins combine two panels
- Upholstered with 1 colour fabric or 2 colour fabric combination

Fittings for height adjustable screens

- Compatible Nova A and single Motion desks
- Screens are inserted into the fittings (154x124xH74 mm)
- Pressed with screws to ensure stability
- Fixed to the desktop

Height adjustment (not available for Motion 2-desk benches)

- Screens can be raised / lowered to the preferred height;
- Only two screws must be tightened to ensure stability.

Fittings for fixed height screens

- Screens are inserted into the fittings (77x44, H=205 mm);
- Fixing to the cable tray holder.

Screen composition (46 mm)

- Frame made of 18x80mm MDF
- Central layer made of 20mm open-cell foam made of melamine resin (BASOTECT G+)
- Second layer is made of VB3842 10 mm foam from both sides
- Third layer is made of VB2240 3mm foam from both sides
- Dowel pins combine two panels
- Upholstered with 1 colour fabric or 2 colour fabric combination

Fittings for screens

- Fittings are knocked in to the screen
- Fixing to the cable tray holder

Materials

G1 Fabric

Berta

G2 Fabric*

Camira Lucia 

G3 Fabric*

Velito Presto
Camira Synergy
Step/Step Melange

Metal brackets



Black (A)
Grey (M)
White (E)

 Eco friendly

Height in brackets is screen height above the desktop, with the desktop at its lowest position.

** Not every fabric in Camira ranges is available on Narbutas products - please see fabrics section at back of price list for details*

*** Modus screens can be upholstered in a different colour on each side, however it must be from the same fabric range.*

	CODE	DESCRIPTION	WIDTH	DEPTH	HEIGHT	G1 (£)	G2 (£)	G3 (£)
	APK120	Desktop screen for W1200mm single desk	1200	42	740	379	465	520
	APK140	Desktop screen for W1400mm single desk	1400	42	740	400	481	542
	APK160	Desktop screen for W1600mm single desk	1600	42	740	449	541	602
	APK180	Desktop screen for W1800mm single desk	1800	42	740	678	820	918
	APK141	Acoustic screen (class C) for W1400mm Motion 2 stage back-to-back bench	1400	42	600 (515)	368	448	490
	APK161	Acoustic screen (class C) for W1600mm Motion 2 stage back-to-back bench	1600	42	600 (515)	390	476	526
	APK181	Acoustic screen (class C) for W1800mm Motion 2 stage back-to-back bench	1800	42	600 (515)	436	529	597
	APK143	Acoustic screen (class C) for W1400mm Motion 2 stage back-to-back bench	1400	46	600 (515)	392	472	527
	APK163	Acoustic screen (class C) for W1600mm Motion 2 stage back-to-back bench	1600	46	600 (515)	426	519	581
	APK183	Acoustic screen (class C) for W1800mm Motion 2 stage back-to-back bench	1800	46	600 (515)	732	893	999
	APK142	Acoustic screen (class C) for W1400mm Motion 3 stage back-to-back bench	1400	42	740 (660)	419	505	560
	APK162	Acoustic screen (class C) for W1600mm Motion 3 stage back-to-back bench	1600	42	740 (660)	619	761	854
	APK182	Acoustic screen (class C) for W1800mm Motion 3 stage back-to-back bench	1800	42	740 (660)	708	868	968
	APK144	Acoustic screen (class C) for W1400mm Motion 3 stage back-to-back bench	1400	46	740 (660)	461	565	634
	APK164	Acoustic screen (class C) for W1600mm Motion 3 stage back-to-back bench	1600	46	740 (660)	650	798	891
	APK184	Acoustic screen (class C) for W1800mm Motion 3 stage back-to-back bench	1800	46	740 (660)	874	1,084	1,208

	CODE	DESCRIPTION	WIDTH	DEPTH	HEIGHT	RSP (£)
	APZ001	Metal fittings for mounting Modus screens on Motion back-to-back bench (only required if central cable tray is not ordered)	62	60	128	64

My Space

Fabric acoustic dividers / desking

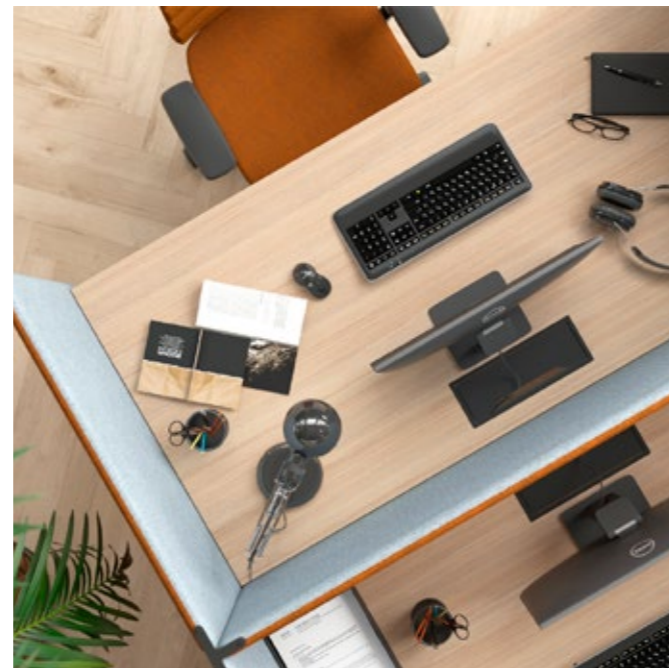

My Space absorbs noise and divides your office into personal workspaces.

You can choose from a mounted desktop or freestanding screen system, suitable for 720-780mm height desks. Components are quick and easy to connect and assemble.

Acoustic screens are filled with special acoustic sound-absorbing foam, certified sound absorption Class D, and can be upholstered with a fabric of your choice. Use a variety of colour combinations not only to create

separate spaces but also to arrange workstations in groups. This updated range now includes 120° brackets and trapezoidal desktops to greatly expand the desk arrangement possibilities.

Thanks to the modular construction, this acoustic furniture allows you to power up to 6 workplaces from a single power socket. In order to keep the working process as effective as possible, My Space is available with a 3 socket power unit that can be used for standard power supply, USB, or data connection in different configurations.

Range

Screens

For use without desktop (no desktop brackets)

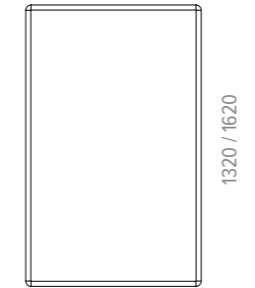

824 / 1024 / 1224 / 1424 / 1624

For use with desktop (brackets on one side)

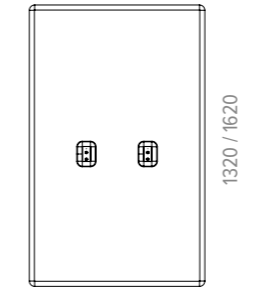

824 / 1024 / 1224 / 1424 / 1624

For use with desktop (brackets on both sides)

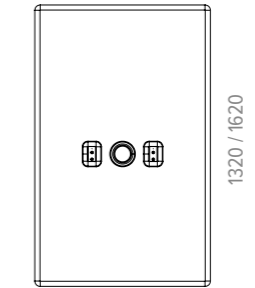

824 / 1024 / 1224 / 1424 / 1624

Rectangular desktops

With scoop back



800 / 1000 / 1200 / 1400 / 1600

With rectangular cutout

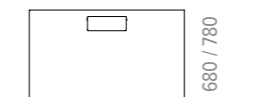

800 / 1000 / 1200 / 1400 / 1600

With round cutout

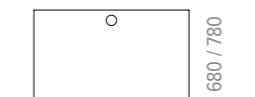

800 / 1000 / 1200 / 1400 / 1600

Trapezoidal desktops

With scoop back*

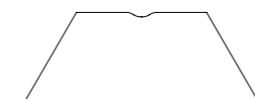

1791 / 1907

With rectangular cutout*

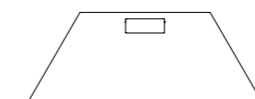

1791 / 1907

With round cutout*

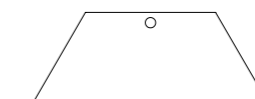

1791 / 1907

Single leg tables

With straight back

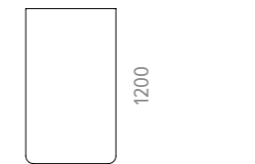

700

With rectangular cutout

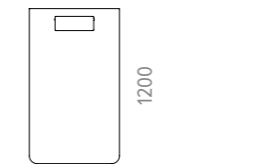

700

With round cut-out

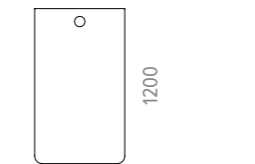

700

Materials

G1 Fabric

Berta

G2 Fabric**

Camira Lucia

G3 Fabric**

Step/Step Melange

Camira Synergy

Velito Presto

Band A MFC

Whitened Oak (D1)

Amber Oak (D2)

White (M1)

Pearl Grey (N3)

Band B MFC

Sand Ash (D3)

Dark Walnut (D4)

Grey Wood (D5)

Cubanit Grey (N2)

Metal

Anthracite (T1)

Black (A)

Grey (M)

White (E)

Plastic

Black (A)

Grey (M)

White (E)

Eco friendly

Technical

Screen composition

- 16mm chipboard, covered with 10mm acoustic foam, upholstered with fabric

Desktop with metal frame and brackets†

- 25mm MFC with 2mm ABS edging
- Powder coated metal fittings for fixing to screens
- 30x20mm powder coated metal tube







Single leg table with brackets (for single screen)†

- 25mm MFC with 2mm ABS edging
- Powder coated metal fittings for fixing to screens
- 40 x 40mm powder coated metal leg

Feet and top joints†



- Foot and matching top joint are the same finish and therefore under the same purchase code





* Trapezoidal desktops fit W1024mm screens only ** Not every fabric in Camira ranges is available on Narbutas products - please see fabrics section at back of price list for details † Have to be ordered separately for specific combinations

G1: Berta		G2: Lucia		G3: Velito Presto / Step/Step Melange / Synergy				
	CODE	DESCRIPTION	WIDTH	DEPTH	HEIGHT	G1 (£)	G2 (£)	G3 (£)
	ASU080	Screen without desktop fittings	824	36	1320	344	465	528
	ASU100		1024	36	1320	418	563	640
	ASU120		1224	36	1320	500	676	766
	ASU140		1424	36	1320	571	775	875
	ASU160		1624	36	1320	646	880	987
	ASU081	Screen with desktop fittings for one side	824	36	1320	351	471	535
	ASU101		1024	36	1320	430	577	646
	ASU121		1224	36	1320	505	689	771
	ASU141		1424	36	1320	579	780	881
	ASU161		1624	36	1320	653	888	996
	ASU082	Screen with desktop fittings for two sides and Ø80mm grommet	824	36	1320	363	490	548
	ASU102		1024	36	1320	450	591	666
	ASU122		1224	36	1320	524	695	785
	ASU142		1424	36	1320	597	800	890
	ASU162		1624	36	1320	671	899	1,007
	ASU083	Screen without desktop fittings	824	36	1620	418	512	569
	ASU103		1024	36	1620	525	638	704
	ASU123		1224	36	1620	614	753	830
	ASU143		1424	36	1620	715	861	957
	ASU163		1624	36	1620	804	976	1,077
	ASU084	Screen with desktop fittings for one side	824	36	1620	430	519	577
	ASU104		1024	36	1620	543	653	715
	ASU124		1224	36	1620	628	756	843
	ASU144		1424	36	1620	721	869	957
	ASU164		1624	36	1620	832	1,004	1,106
	ASU085	Screen with desktop fittings for two sides and Ø80mm grommet	824	36	1620	450	544	590
	ASU105		1024	36	1620	556	665	727
	ASU125		1224	36	1620	646	779	849
	ASU145		1424	36	1620	753	905	995
	ASU165		1624	36	1620	830	1,007	1,097







		G1: Band A MFC			G2: Band B MFC		
	CODE	DESCRIPTION	WIDTH	DEPTH	HEIGHT	G1 (£)	G2 (£)
	ASD080	Desktop with scoop back for cable management and metal frame, height adjustment 720 - 780 mm	800	680	25	189	206
	ASD081		800	780	25	204	224
	ASD100		1000	680	25	225	239
	ASD101		1000	780	25	233	252
	ASD120		1200	680	25	241	266
	ASD121		1200	780	25	247	292
	ASD140		1400	680	25	262	293
	ASD141		1400	780	25	281	312
	ASD160		1600	680	25	292	324
	ASD161		1600	780	25	307	346
		ASD082	Desktop with cutout for Ø80mm grommet* and metal frame, height adjustment 720 - 780 mm	800	680	25	202
ASD083			800	780	25	216	234
ASD102			1000	680	25	219	239
ASD103			1000	780	25	242	262
ASD122			1200	680	25	241	266
ASD123			1200	780	25	243	286
ASD142			1400	680	25	262	293
ASD143			1400	780	25	280	311
ASD162			1600	680	25	292	324
ASD163			1600	780	25	309	348
		ASD084	Desktop with a cutout for cable flap** and metal frame, height adjustment 720 - 780 mm	800	680	25	202
	ASD085		800	780	25	216	234
	ASD104		1000	680	25	224	236
	ASD105		1000	780	25	234	254
	ASD124		1200	680	25	243	268
	ASD125		1200	780	25	247	292
	ASD144		1400	680	25	262	292
	ASD145		1400	780	25	284	316
	ASD164		1600	680	25	292	324
	ASD165		1600	780	25	304	343
		ASD170	Desktop with a scoop back for cable management and metal frame, height adjustment 720 - 780 mm	1791	680	25	317
ASD190			1907	780	25	344	388
ASD171		Desktop with a cut-out for Ø80mm grommet* and metal frame, height adjustment 720 - 780 mm	1791	680	25	317	355
ASD191			1907	780	25	334	384
ASD172		Desktop with a cutout for cable flap** and metal frame, height adjustment 720 - 780 mm	1791	680	25	318	355
ASD192		1907	780	25	349	401	

* See Solo Plus porthole power modules on page 440
 ** See cable management on page 450 or power units on page 446

	CODE	DESCRIPTION	G1: Band A MFC			G2: Band B MFC	
			WIDTH	DEPTH	HEIGHT	G1 (£)	G2 (£)
	AST120	Table with one leg and metal frame	1200	700	720	328	360
	AST121	Table with Ø80mm cutout and one leg <i>See Solo Plus porthole power modules on page 440</i>	1200	700	720	331	363
	AST122	Table with cutout for cable flap, one leg and metal frame <i>See cable management on page 450 or power units on page 446</i>	1200	700	720	336	367

	CODE	DESCRIPTION	WIDTH	DEPTH	HEIGHT	RSP (£)
	ASZ007	Metal 'O' leg	30	30	18	29
	ASZ008	90° metal 'L' leg and top joint	88	88	18	61
	ASZ009	90° metal 'T' leg and top joint	146	88	18	72
	ASZ010	90° metal 'X' leg and top joint	146	146	18	98

	CODE	DESCRIPTION	WIDTH	DEPTH	HEIGHT	RSP (£)
	ASZ011	Metal 'I' leg and top joint	130	30	18	60
	ASZ012	120° metal 'V' leg and top joint	111	77	18	61
	ASZ013	120° metal 'Y' leg and top joint	124	111	18	80
	ZZZ359	Power unit (3 x AC power sockets) with metal frame	317	119	45	383
	ZZZ360	Power unit (2 x AC power sockets and 1 x RJ45 socket) with metal frame	317	119	45	432
	ZZZ361	Power unit (2 x AC power sockets and 1 x USB fast charger type-A and type-C) with metal frame	317	119	45	773
	ZZZ362	Power unit (1 x AC power socket and 1 x USB fast charger type-A and type-C, 1 x RJ45 socket) with metal frame	317	119	45	895

	CODE	DESCRIPTION	WIDTH	DEPTH	HEIGHT	RSP (£)
	S1-1P3C(1A/2C)1D1H-BK	Metalicon Solo Plus power socket with integrated 18W USB-A & 45W USB-C smart charge, 1 x HDMI data transfer port and 1 x Cat6 RJ45 data transfer port, black.	Ø110		65	182
	UPMA-3P-SV	Under-desk power module, 3 x Type G (UK) sockets Power cable must be ordered				42
	ZZZ351	Distributor block GST18i3 (1 IN, 2 OUT) w/ extension cable				112
	PL-UKWF/01	1m starter cable, mains to GST 3-pole female connector, black*				18
	PL-UKWF/02	2m starter cable, mains to GST 3-pole female connector, black*				18
	PL-UKWF/03	3m starter cable, mains to GST 3-pole female connector, black*				22
	PL-WMWF/01	1m connector cable, GST 3-pole male to female connector, black*				16
	PL-WMWF/02	2m connector cable, GST 3-pole male to female connector, black*				19
	ZNZ010	Rectangular metal desk grommet	320	130	25	90
	DNZ019	Cable tray L=500mm	500	100	110	73

	CODE	DESCRIPTION	WIDTH	DEPTH	HEIGHT	G1 (£)	G2 (£)	G3 (£)
	ASK001	A single U shape workstation	1476	850	1342	1656	2121	2381
	ASK002	A double U shape workstation	2916	850	1342	2908	3733	4167
	ASK003	A double alternating U shape workstation	2916	850	1342	2927	3751	4185
	ASK004	A 4-desk H shape workstation	2916	1664	1342	4607	5822	6455
	ASK005	A single V shape workstation	2078	912	1342	1718	2201	2443
	ASK006	A double alternating V shape workstation	3625	912	1342	2995	3789	4198
	ASK007	A 3-desk V shape workstation	3112	2700	1342	4247	5351	5928
	ASK008	A 4-desk V shape workstation island	4120	1805	1342	4619	5686	6281
	ASK009	A 3-desk V shape workstation island	3100	2700	1342	3807	4737	5239

Freestanding

Fabric acoustic screens



Freestanding sound-absorbing acoustic screens not only separate your workspace from noise within the office environment, but also help you to create distinct, colorful office spaces. Portable screens are easily movable all around the office.

Technical

- Made of 16mm chipboard, covered with 10mm acoustic foam, upholstered with fabric
- Certified sound absorption - class C
- Set of 4 metal legs with or without Ø50mm castors

Materials

G1 Fabric

Berta

G2 Fabric*

Camira Lucia 



G3 Fabric*





Velito Presto
Camira Synergy

Metal

Anthracite (T1)
Black (A)
Grey (M)
White (E)

 Eco friendly

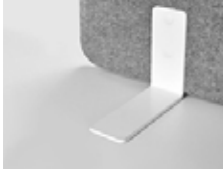
	CODE	DESCRIPTION	WIDTH	DEPTH	HEIGHT	G1 (£)	G2 (£)	G3 (£)
	AFU083	Free standing screens, W800mm	800	36	1200	393	416	514
	AFU080		800	36	1400	445	463	537
	AFU081		800	36	1600	478	497	565
	AFU082		800	36	1800	552	731	942
	AFU100	Free standing screens, W1000mm	1000	36	1200	483	557	655
	AFU101		1000	36	1400	531	568	668
	AFU102		1000	36	1600	569	590	693
	AFU103		1000	36	1800	619	798	997
	AFU120	Free standing screens, W1200mm	1200	36	1200	544	668	780
	AFU121		1200	36	1400	580	678	796
	AFU122		1200	36	1600	636	705	817
	AFU123		1200	36	1800	675	861	1,040
	AFU140	Free standing screens, W1400mm	1400	36	1200	546	696	777
	AFU141		1400	36	1400	635	801	894
	AFU142		1400	36	1600	673	835	915
	AFU143		1400	36	1800	743	929	1,102
	AFU160	Free standing screens, W1600mm	1600	36	1200	566	710	796
	AFU161		1600	36	1400	680	861	941
	AFU162		1600	36	1600	739	954	1,035
	AFU163		1600	36	1800	805	992	1,152

	CODE	DESCRIPTION	WIDTH	DEPTH	HEIGHT	RSP (£)
	AFZ001	'I' metal connectors Connects 2 screens inline (2 pcs.)	112	34	8	26
	AFZ002	'L' metal connectors Connects 2 screens at a right angle (2 pcs.)	86	60	8	33
	AFZ003	'T' metal connectors Connects 3 screens, 1 at a right angle (2 pcs.)	138	60	8	45
	AFZ040	Set of metal legs (4 pcs.)	400	-	-	165
	AFZ041	Set of metal feet on Ø50mm castors (4 pcs.)	400	-	-	267

Acoustic Artwork

PET felt acoustic partitions + baffles

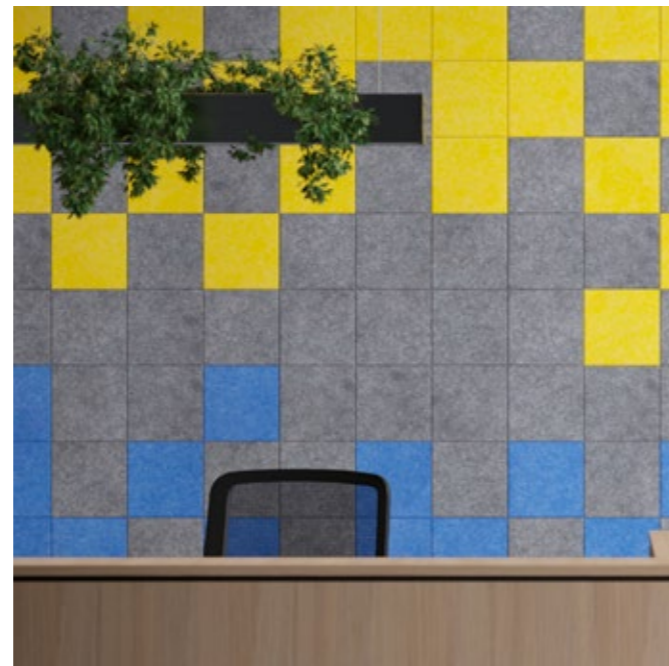
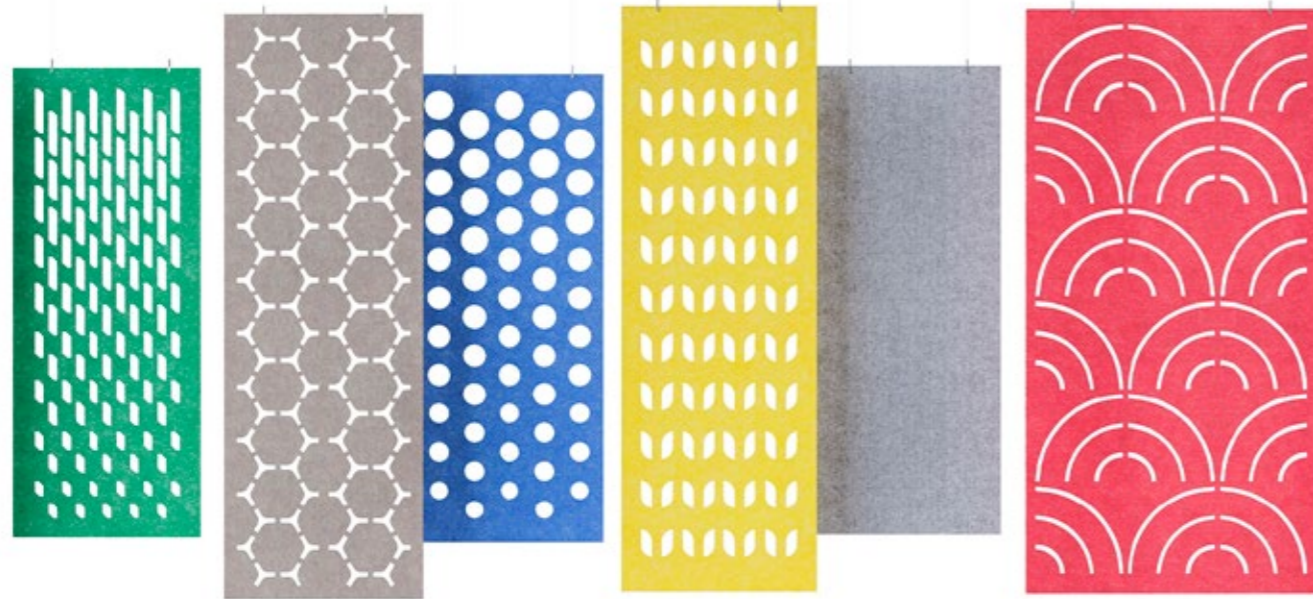

Choose from three types of wall-mounted or ceiling-mounted acoustic products: partitions, clouds and tiles are all lightweight and versatile and help you to create acoustic comfort, creatively divide spaces and achieve a unique office interior.

Partly made of recycled plastic PET felt acoustic products feel similar to wool to touch but are made from plastic using more than 50 per cent recycled plastic, making them suitable for recycling.

This sustainable material possesses excellent sound absorption properties. The porous structure ensures efficient absorption of medium to high frequency noise despite the low thickness of product. PET felt is soft and light, yet strong and durable. It also has a required degree of fire resistance and meets applicable fire safety requirements. Due to the structure PET felt can be easily cleaned and disinfected.

Partitions come in a variety of patterns featuring circles, hexagons, grids, and a variety of wavy patterns.

Range

Partitions

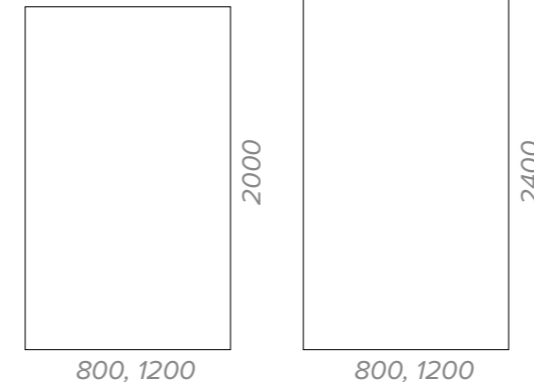

Clouds

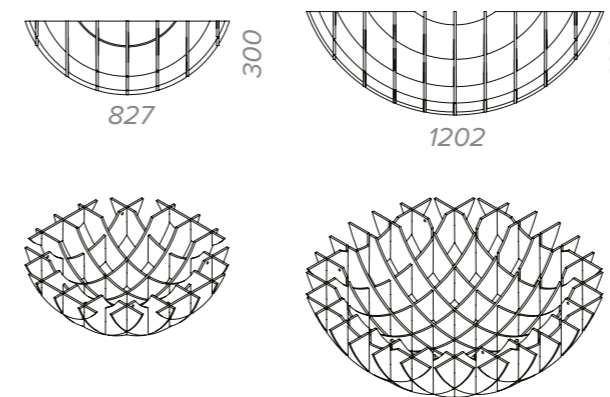

Tiles

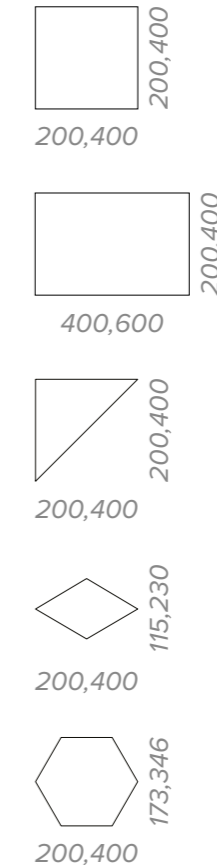

Materials

PET Felt* ♻️

- Grey (B18)
- Light Grey (B19)
- Green (B44)
- Dark Blue (B50)
- Blue (B51)
- Coral Pink (B56)
- Chestnut (B53)
- Dark Pink (B52)
- Dark Grey (B54)
- Lime (B55)
- Light Grey (B58)
- Light Beige (B57)

G1 Pattern

- Plain (ZB0)

G2 Patterns

- Dot (ZB1)
- Flo (ZB3)
- Disco (ZB4)

G3 Patterns

- Hex (ZB2)
- Grate (ZB5)

Metal

- Chrome (H)

♻️ Eco friendly

Technical

Screen composition

- PET fibre board 9mm

Suspension set AWZ001 (2 pcs.)

- Suitable only for PET partitions (up to 10mm thick)
- Only a single product can be suspended per set
- Set includes ceiling mounting (masonry/wood/gypsum)
- Adjustable cable grip
- Ø1.5mm wire rope L-50-2000mm

Suspension set AWZ002 (1 pc.)

- Suitable only for PET clouds
- Only a single product can be suspended per set
- Set includes ceiling mounting (masonry/wood/gypsum)

- Ø1.5mm wire rope L50-2000mm
- Adjustable cable grip
- Two Ø1.5mm wire ropes with metal plates L1500mm

Suspension set AWZ004 (2 pcs.)

- Suitable only for PET partitions (up to 10mm thick)
- Only a single product can be suspended per set
- Set includes ceiling mounting (for T24 Armstrong profile)
- Adjustable cable grip
- Ø1.5mm wire rope L50-2000mm

Suspension set AWZ003 (1 pc.)

- Suitable only for PET clouds
- Only a single product can be suspended per set

- Set includes ceiling mounting (for T24 Armstrong profile)
- Ø1.5mm wire rope L50-2000mm
- Adjustable cable grip
- Two Ø1.5mm wire ropes with metal plates L1500mm

Adhesive fittings

- Included for each PET tile
- Thickness 0.2mm
- Temperature for application or removal min 15°C
- Temperature resistance 5-35°C
- Adhesive fittings for wall or ceiling (glass / wood / plastic / ceramics / varnished surfaces)**
- Not suitable for use on vinyl wallpaper and anti-stick surfaces

* See PET felt colour swatches on page 464 ** The adhesive must flow onto the surface and create full surface contact. The surface to be bond must be free of grease, loose particles and moisture!

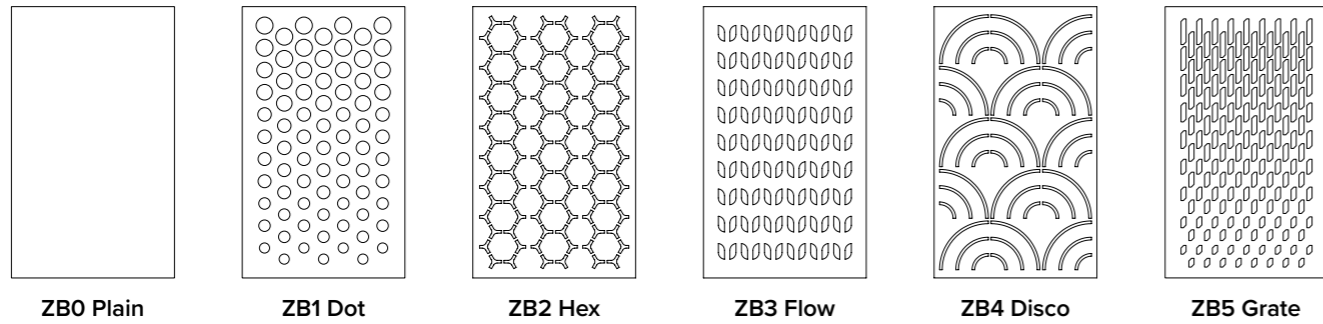

G1: Pattern ZB0		G2: Patterns ZB1 / ZB3 / ZB4			G3: Patterns: ZB2 / ZB5			
	CODE	DESCRIPTION	WIDTH	DEPTH	HEIGHT	G1 (£)	G2 (£)	G3 (£)
	AWU081	PET partition, 1 pcs.	800	9	2000	484	668	763
	AWU082		800	9	2400	509	741	819
	AWU121		1200	9	2000	502	787	943
	AWU122		1200	9	2400	526	871	1,007
	AWU083	PET partition, 3 pcs.	800	9	2000	1,294	1,853	2,145
	AWU084		800	9	2400	1,363	2,053	2,297
	AWU123		1200	9	2000	1,387	2,238	2,708
	AWU124		1200	9	2400	1,430	2,460	2,877
	AWU085	PET partition, 5 pcs.	800	9	2000	2,207	3,140	3,624
	AWU086		800	9	2400	2,268	3,423	3,829
	AWU125		1200	9	2000	2,150	3,561	4,353
	AWU126		1200	9	2400	2,312	4,039	4,724

Plain (ZB0)							
	CODE	DESCRIPTION	WIDTH	DEPTH	HEIGHT	RSP (£)	
	AVU221	PET square tile, 3 pcs, set of adhesive fittings included	200	9	200	68	
	AVU421		400	9	400	120	
	AVU241	PET square tile, 5 pcs, set of adhesive fittings included	200	9	200	115	
	AVU441		400	9	400	200	
	AVU291	PET square tile, 10 pcs, set of adhesive fittings included	200	9	200	223	
	AVU491		400	9	400	383	
	AVU222	PET rectangular tile, 3 pcs, set of adhesive fittings included	200	9	400	88	
	AVU422		400	9	600	158	
	AVU242	PET rectangular tile, 5 pcs, set of adhesive fittings included	200	9	400	151	
	AVU442		400	9	600	250	
	AVU292	PET rectangular tile, 10 pcs, set of adhesive fittings included	200	9	400	288	
	AVU492		400	9	600	480	
	AVU223	PET triangular tile, 4 pcs, set of adhesive fittings included	200	9	200	68	
	AVU423		400	9	400	115	
	AVU243	PET triangular tile, 6 pcs, set of adhesive fittings included	200	9	200	109	
	AVU443		400	9	400	170	
	AVU293	PET triangular tile, 10 pcs, set of adhesive fittings included	200	9	200	171	
	AVU493		400	9	400	271	

	CODE	DESCRIPTION	WIDTH	DEPTH	HEIGHT	RSP (£)
	AVU224	PET hexagon tile, 3 pcs, set of adhesive fittings included	173	9	200	68
	AVU424		346	9	400	119
	AVU244	PET hexagon tile, 5 pcs, set of adhesive fittings included	173	9	200	110
	AVU444		346	9	400	205
	AVU294	PET hexagon tile, 10 pcs, set of adhesive fittings included	173	9	200	207
	AVU494		346	9	400	394
	AVU125	PET diamond tile, 3 pcs, set of adhesive fittings included	115	9	200	73
	AVU225		230	9	400	92
	AVU145	PET diamond tile, 5 pcs, set of adhesive fittings included	115	9	200	98
	AVU245		230	9	400	162
	AVU195	PET diamond tile, 10 pcs, set of adhesive fittings included	115	9	200	198
AVU295		230	9	400	302	
	AWU080	PET cloud SHADE, Ø827	Ø827	-	-	504
	AWU120	PET cloud SHADE, Ø1202	Ø1202	-	-	1,375
	AWZ001	Set of suspensions for PET partition. Adjustable wire rope length 50 - 2000 mm. Fixed on wood, masonry, gypsum (ceiling).	-	-	2000	115
	AWZ004	Set of suspensions for PET partition. Adjustable wire rope length 50 - 2000 mm. Fixed on suspended ceilings "Armstrong" (profile T24) with white clips.	-	-	2000	151
	AWZ002	Set of suspensions for PET cloud. Adjustable wire rope length 50 - 2000 mm. Fixed on wood, masonry, gypsum (ceiling).	-	-	2000	98
	AWZ003	Set of suspensions for PET cloud. Adjustable wire rope length 50 - 2000 mm. Fixed on suspended ceilings "Armstrong" (profile T24) with white clips.	-	-	2000	109

Parthos NEW

Acoustic columns



Parthos stylish, mobile and sustainable acoustic columns are one of the solutions that can achieve the desired acoustic balance in different spaces. Best of all, they require no special fixings, thus giving you more freedom and flexibility.

Parthos ensures that high, medium and low frequency sounds are muffled: High-frequency sounds like phone calls, medium-frequency sounds like speech, and low-frequency sounds caused by heating, ventilation and air conditioning systems. The acoustic columns are filled with textile offcuts, with excellent sound-absorbing

properties. Columns are covered with PET felt, which is porous and enhances these properties. The choice of pattern also contributes to the improvement of acoustics by dispersing some of the sound waves.

Choose from three different heights – 800 mm, 1200 mm, and 1600 mm with space for a plant pot hooks is an acoustic product with a distinctive design that can be easily integrated into meeting spaces. You can use hooks or with power and charge.

Range

Column

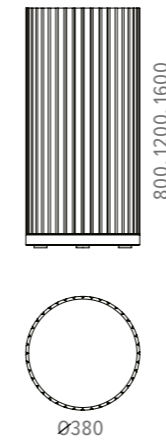

Column for plant pot

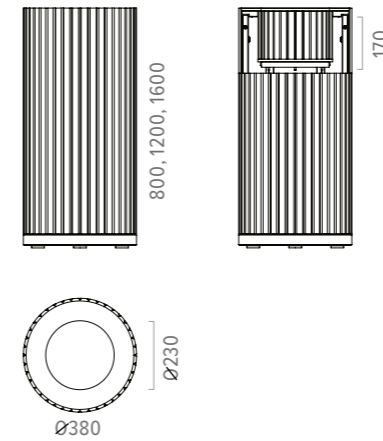

Column with hooks

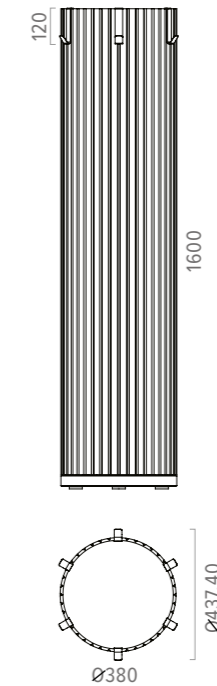

Column with power

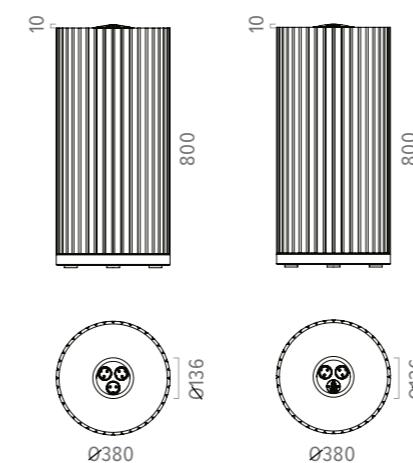

Materials

PET Felt

- Grey (B18)
- Light Grey (B19)
- Green (B44)
- Dark Blue (B50)
- Blue (B51)
- Coral Pink (B56)
- Chestnut (B53)
- Dark Pink (B52)
- Dark Grey (B54)
- Lime (B55)
- Light Grey (B58)
- Light Beige (B57)

Pattern

- Vertical (ZP1)

Base

- Black (J4)

Eco friendly

Technical

Surface cover

- Cover made of 9mm PET fibre board

Internal structure

- Welded power coated metal frame made of 20x20 mm metal tube and 2mm metal sheet
- Concrete counterweight

Base







- 36mm MFC with 2mm ABS edging
- Adjustable height levelling feet, H9-14 mm, 6 pcs

Acoustic fill

- Composition of acoustic filler (made from cut-offs) – mix of polyester and cotton
- Column weight may vary due to use of fabric cut-offs as acoustic filling

Hooks

- Hooks made of 1.5mm power coated metal sheet, 6 pcs
- Dimensions – 30x25x120 mm
- Recommended maximum weight per hook – 2kg

	CODE	DESCRIPTION	WIDTH	DEPTH	HEIGHT	RSP (£)
	APA080	Acoustic column	Ø380		800	900
	APA120		Ø380		1200	1,306
	APA160		Ø380		1600	1,430
	APA081	Acoustic column with space for plant pot (Ø230 x H170 mm)	Ø380		800	957
	APA121		Ø380		1200	1,358
	APA161		Ø380		1600	1,488
	APA162	Acoustic column with hooks	Ø380		1600	1,576
	APA082	Acoustic column with power socket unit (3 x Type G (UK) power sockets)	Ø380		800	1,441
	APA083	Acoustic column with power socket unit (2 x Type G (UK) power sockets and 1 x USB Type A+C charge socket)	Ø380		800	1,748
	APA084	Acoustic column with power socket unit (3 x Type G (UK) power sockets and wireless charger)	Ø380		800	1,852
	APA085	Acoustic column with power socket unit (2 x Type G (UK) power sockets, 1 x USB Type A+C socket and wireless charger)	Ø380		800	2,158



Modus & Modus Light

Acoustic sound absorption panels



Modus acoustic panels offer a modern solution to improve the working environment by absorbing background noise, reducing reverberation and improving acoustics.

With a broad range of fabric colours on offer Modus panels add depth and interest to office interiors and can be used to create private working spaces. The system includes wall mounted panels, suspended ceiling panels, and vertically suspended double-sided panels.

The main purpose of acoustic panels is to reduce reverberation (echo) to the maximum extent possible and to absorb noise, in this way improving acoustic comfort. The panels contain a special patented and certified material designed to efficiently absorb sound. Modus acoustic panels offer class C sound absorption.

Technical

MODUS LIGHT LIGHTWEIGHT ACOUSTIC PANELS

- ±1mm tolerance on panel dimensions
- Acoustic foam A and C class sound absorption (according to DIN EN ISO 354 standard)

Fixings

- Adhesive fittings for wall or ceiling (glass / plastic / metal / ceramics / varnished surfaces)
- Screwed fittings for wall or ceiling (masonry / wood / gypsum)

Wall and ceiling acoustic panel composition

- Acoustic foam glued to white painted HDF - 3mm
- Upholstered using Velcro straps

Acoustic panel composition for Armstrong ceiling from 600x600 mm modules

- Acoustic foam glued to white painted HDF - 3mm
- Upholstered using Velcro straps
- Zinc metal strip suspension for "Armstrong" type ceiling.

Practical sound absorption

- 68 mm thickness class A sound absorber
- 48 mm thickness class C sound absorber

MODUS ACOUSTIC PANELS

- ±1mm tolerance on panel dimensions
- Acoustic foam C class sound absorption (according to DIN EN ISO 354 standard)

Double-sided ceiling panels

- Frames made of 18mm plywood
- 20mm acoustic foam
- 10mm foam HR3030
- Covered with 3mm foam VB2240
- Upholstered with fabric

One-sided ceiling & wall panels

- Frames made of 30mm plywood
- Covered with 3mm foam VB2240
 - 20mm acoustic foam
 - Upholstered with fabric
 - Spunbond.

Fittings

- Drilled to the wall fittings
- Adhesive fittings (for glass or quick assembly)
- Connection components for the panels of the same length
- Ceiling panels suspension set (50-3000 mm)
- Double-sided (vertical) panels suspension set (50-3000 mm)
- Double-sided (vertical) panels suspension set for interconnect (50-1200 mm)



Vertically suspended panels



Horizontally suspended panels

Materials

Fabric*













- Berta
- Bondai
- Camira Era
- Camira Lucia 
- Velito Presto
- Step/Step Melange
- Camira Synergy

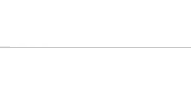



Metal







- Chrome (H) cables
- Grey (M) fixings

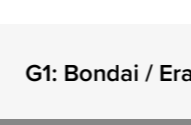



 Eco friendly

* Not every fabric in Camira ranges is available on Narbutas products - please see fabrics section at back of price list for details

G1: Berta		G2: Lucia			G3: Velito Presto / Step/Step Melange / Synergy				
	CODE	DESCRIPTION	WIDTH	DEPTH	HEIGHT	G1 (£)	G2 (£)	G3 (£)	
	APU04A	Modus vertically suspended acoustic panel (upholstered on both sides) with suspension fittings on top, adjustable cables 50-3000mm, suitable for masonry or gypsum	1200	46	400	349	404	453	
	APU04B	Modus vertically suspended acoustic panel (upholstered on both sides) with suspension fittings on top & bottom, adjustable cables 50-3000mm, suitable for masonry or gypsum	1200	46	400	349	404	453	
	APU08A	Modus vertically suspended acoustic panel (upholstered on both sides) with suspension on top, adjustable cables 50-3000mm, suitable for masonry or gypsum	1200	46	800	566	689	758	
	APU08B	Modus vertically suspended acoustic panel (upholstered on both sides) with suspension fittings on top & bottom, adjustable cables 50-3000mm, suitable for masonry or gypsum	1200	46	800	566	689	758	
	APU040	Modus acoustic wall / horizontally suspended ceiling panel (upholstered on one side)	400	40	400	101	120	139	
	APU070		400	70	400	124	161	186	
	APU041		400	40	800	145	195	220	
	APU071		400	70	800	197	248	284	
	APU042		400	40	1200	208	257	301	
	APU072		400	70	1200	262	336	384	
	APU043		800	40	800	307	395	445	
	APU073		800	70	800	409	520	587	
	APU044		800	40	1200	371	470	531	
	APU074		800	70	1200	491	621	708	
	APU045		1200	40	1200	662	842	953	
	APU075		1200	70	1200	880	1,116	1,259	

	CODE	DESCRIPTION				RSP (£)		
	APU047	Wall panel drilled and adhesive fixings (up to 20kg load)				63		
	APU048	Wall panel adhesive fixings (up to 4kg load)				64		
	APU049	Wall panel connectors (2 pcs.)				26		
	APU050	Ceiling panel cable kit for Modus horizontally suspended panels, 50 - 1200 mm				76		
	APU051	Ceiling panel cable kit for Modus horizontally suspended panels, 50 - 3000 mm				133		

G1: Bondai / Era		G2: Lucia			G3: Velito Presto / Step/Step Melange / Synergy				
	CODE	DESCRIPTION	WIDTH	DEPTH	HEIGHT	G1 (£)	G2 (£)	G3 (£)	
	APU030	Modus Light lightweight acoustic wall / ceiling panel	300	48	300	80	101	112	
	APU031		300	68	300	97	114	129	
	APU060		600	48	300	143	170	186	
	APU061		600	68	300	178	204	226	
	APU062		600	48	600	237	291	318	
	APU063		600	68	600	307	366	398	
	APU064	Modus Light acoustic panel with metal fittings - fix to Armstrong suspended ceiling	575	48	575	241	268	295	
	APU065		575	68	575	300	316	348	

	CODE	DESCRIPTION	RSP (£)
	APU001	Set of drilled fittings (4 pcs.) for Modus Light acoustic panels - fix to wood, masonry or gypsum wall / ceiling	64
	APU002	Set of adhesive fittings (4 pcs.) for Modus Light acoustic panels - fix to glass, plastic, metal, ceramics and varnished wall / ceiling, supports loads up to 4kg	39
	APU003	Suspension cables (4pcs.) for Modus Light acoustic panels - fix to masonry, wood or gypsum ceilings, adjustable wire rope length 50-1200mm	51
	APU004	Suspension cables (4pcs.) for Modus Light acoustic panels - fix to Armstrong suspended ceilings (profile T24) with white clips, adjustable wire rope length 50-1200mm, recommended load up to 20kg	114

Workpods & Booths

Workpods

Meeting booths



Arcipelago Wood meeting booth

Silent Room

Acoustic workpods

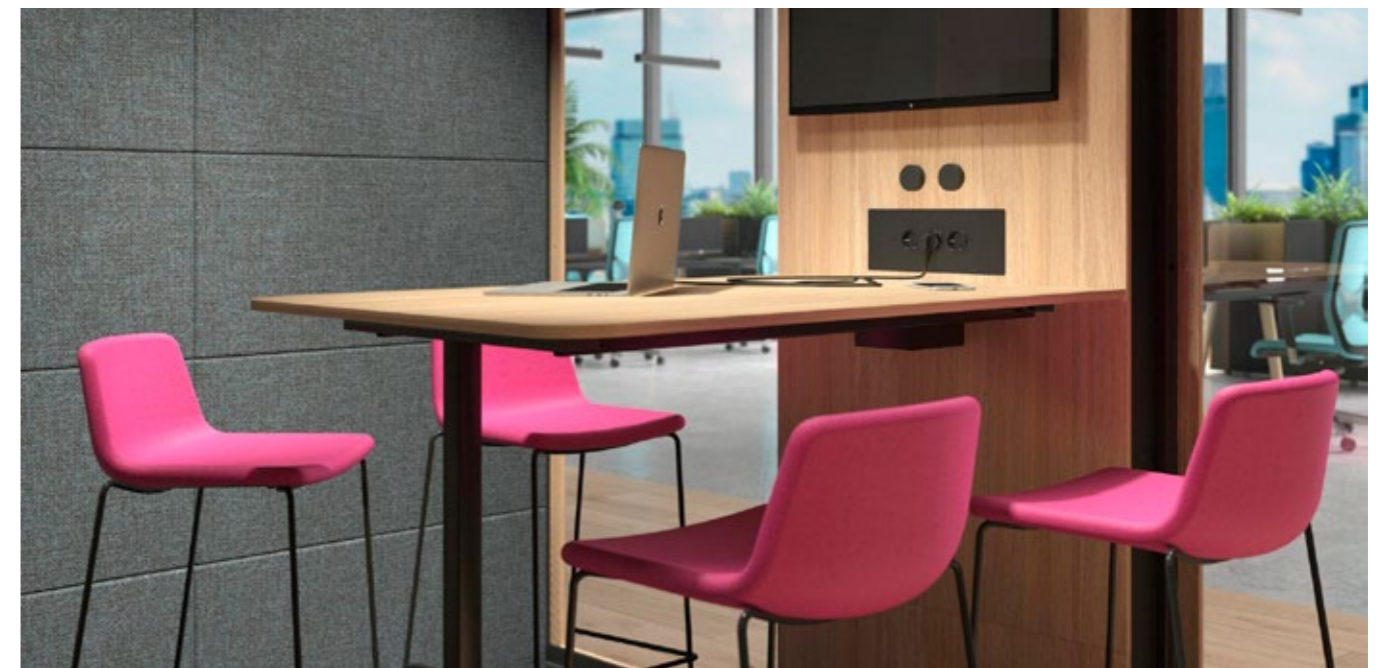

Silent Room is an oasis of quiet in a middle of a modern office. Thanks to this office solution, concentrating at work has never been easier as it enables employees to focus during phone conversations, video conferences or creative tasks without distracting others. Silent Room ensures indoor air quality as well as acoustic and visual comfort for employees.

Multilayered Silent Room wall structure, hermetic door and ceiling ensure sound insulation. The inner layer of the panels is made from high-class acoustic

material that eliminates echo and has excellent sound absorption properties. The upholstered exteriors block out noise effectively and create an acoustically-optimised working environment.

Getting in and out of the Silent Room is easy: a low doorstep and same level floor ensures that no caution is needed while stepping inside. Silent Room ensures a high level of comfort and allows for a wide range of freedom. It can be also easily adapted to a variety of activities, providing you with the freedom to create a personalised setting that suits your needs best. You can

be sure that you will be able to continue that important conversation or presentation even if your device runs out of battery power. For user convenience, Silent Room room is equipped with a power socket with USB-A and USB-C charge.

Thanks to its air ventilation and lighting solutions, Silent Room offers a productivity-boosting environment. The high-capacity ventilators ensure a proper air flow rate (500 m³/h) with a low operating noise.

The combination of the LED lamps creates a warm and homely atmosphere. A smart control unit selects an optimal ventilation and illumination level, and, if necessary, allows for individual adjustment. Once an employee leaves the Silent Room, intense ventilation is automatically activated to prepare the room for the next user.

This acoustic piece of furniture also helps with energy savings as it automatically dims the lights when no one is present in the room and even switches them off after some time.

Technical details

EXTERNAL WALLS (S / M / L / XL)

Options

- Upholstered with fabric
- Melamine
- Upholstered with fabric. Rear wall with glass
- Melamine. Rear wall with glass

5 panels upholstered with fabric

- Welded frame is made of metal tube 40x20mm
- Angular brackets are made of 40x40 mm powder coated metal tubes
- Plastic feet with height levelling (+30mm)
- 12mm MFC (melamine)
- Covered with 3mm foam
- Upholstered with fabric

1 solid panel from melamine

- Welded frame is made of metal tube 40x20 mm
- Angular brackets are made of 40x40 mm powder coated metal tubes
- Plastic feet with height levelling (+30mm)
- 16mm MFC (melamine) with 1mm ABS edging

Walls with glass panes

- Welded frame is made of powder coated metaltube 40x20 mm
- Inside gasket is made of 12mm MFC (melamine) with 1mm ABS edging
- Front sides and top of the metal frame are covered with 16mm MFC (melamine) with 1mm ABS edging
- 8mm TSG (tempered safety glass), clear

INTERNAL ACOUSTIC WALLS (S / M / L / XL)

Panels upholstered with fabric

- Frame is made of 40x20 mm powder coated metal metal tube
- 12mm MFC (melamine)
- 40mm of acoustic foam
- Upholstered with fabric

INTERNAL FRONT WALLS (S / M / L / XL)

Options

- Upholstered with fabric
- Melamine panel
- If you order external walls with glass panes, you do not need to choose internal front walls

Panels upholstered with fabric

- Frame is made of 40x20 mm powder coated metal tube
- 12mm MFC (melamine)
- Covered with 3mm foam
- Upholstered with fabric

Melamine panel

- Frame is made of 40x20 mm powder coated metal tube
- 16mm MFC (melamine) with 1mm ABS edging

INTERNAL FRONT CENTRAL WALL

Wall with control unit (S)

- Top front panel is made of 16mm MFC (melamine) with 1mm ABS edging
- Bottom front panel with hinges is made of 16mm MFC with 1mm ABS edging
- Sides and internal construction parts made of 16mm MFC with 0.5mm ABS edging
- Ventilation and lighting dimming knobs are made of PA 2200 (nylon)

Table (S)

- Tabletop: 16mm MFC (melamine) with 1mm ABS edging
- Box for wires (135x150x100 mm) underneath the table top is made of 1mm powder coated metal sheet
- Bracket: 40x20 mm powder coated metal metal tube
- Mounted 1 AC power socket (100-240 V) with or without integrated USB fast charger (USB Type A+C, max 5A)
- Load capacity – 25kg

Control box (S / M / L / XL)

- Input (GST18i3 male): 100-240 V
- Output (GST18i3 female): 100-240 V
- Frequency: 50/60 Hz
- Power cable: Type G (UK) to GST18i3 female, 3m
- Power output cable length: 0.5m - GST18i3 male to GST18i3 female
- Power consumption – max. 229W, standby 4.5W

Options (M / L / XL)

- Internal front central wall with electronic control system
- Internal front central wall with low table, VESA mount and electronic control system
- Internal front central wall with high table, VESA mount and electronic control system

Wall with control unit (M / L / XL)

- Top front panel is made of 16mm MFC with 1mm ABS edging
- Bottom front panel with hinges is made of 16mm MFC with 1mm ABS edging
- Sides and internal construction parts are made of 16mm MFC with 0.5mm ABS edging
- Ventilation and lighting dimming knobs are made of PA 2200 (nylon)
- Cable guides are located on both sides of the wall (only for units without tables).

Table (M / L / XL)

- 720mm or 1050mm tabletop height option
- Tabletop is made of 16mm MFC (melamine) with 1mm ABS edging
- Box for wires (135x150x100 mm) underneath the table top is made of 1mm powder coated metal sheet
- Table frame is made of 40x20 mm metal tube
- Top of the leg is made of 70x20 mm metal tube
- Leg base is made of 40x40 mm powder coated metal tube
- Feet with height levelling (+10mm)

Screen bracket (M / L / XL)

- Screen bracket base is made from 70x20 mm powder coated metal tube
- VESA plate (120x120 mm) is made of 2mm metal sheet
- VESA standards – 75x75 mm, 100x100 mm and recommended weight is up to 10kg
- Recommended screen size is up to 27"
- VESA plate can be fixed to the holder in 3 different heights
- Bolts for flat screen assembly are not included

CEILING (S M L XL)

Composition

- Double layered ceilings are made of 12mm top and 16mm bottom MFC (melamine) panels with 1mm ABS edging
- Frame is made of 50x20 mm metal tube
- PIR sensor mounted in to central ceiling segment
- Fan grills are made of 1mm powder coated metal sheet
- Air supply duct inside glued with acoustic foam
- Ø60mm cable grommet for optional power supply from ceiling

Lighting

- 3 x LED modules (8.92W) colour temperature approx. 3000K dimmable
- 3 x LED housing (asymmetrical) made of aluminium
- Replacement for LED modules can only be purchased from the manufacturer

Ventilation

- 2 x air supply fans are located in the ceilings
- 2 x air exhaust slots are located in central segment of the ceilings for natural ventilation
- Maximum airflow approx. 200m³/h

DOORS (S / M / L / XL)

- Left-handed or right-handed option
- Powder coated metal door frame is made of 40x40 mm tube and 40x8 mm steel rod
- Aluminium profiles with PVC sealing fixed to internal sides and top and bottom of door frame
- Top of the metal frame is covered with 16mm MFC (melamine) with 1mm ABS edging
- 8mm TSG (tempered safety glass), clear

GLASS FACADE (M / L / XL)

- Powder coated metal door frame is made of 40x20 mm tube
- Inside gasket is made of 12mm MFC (melamine) with 1mm ABS edging
- Front sides and top of the metal frame are covered with 16mm MFC (melamine) with 1mm ABS edging
- 8mm tempered safety glass, clear

FLOORS (optional) (S / M / L / XL)

- Powder coated metal floor frame is made of 40x40 mm and 40x20 mm tube
- Floor panels are made of 25mm MFC with 0.5mm ABS edging
- Floor carpet thickness 3mm, made of PA6 (40%) and PP (60%)
- Skirting boards made of 16mm MFC with 1mm ABS edging
- Plastic feet with height levelling (+30mm)
- Note that the floor adds approximately 70mm to the overall height

CARPET (optional) (S / M / L)

- Carpet thickness 6.5mm, 100% polyamide, antistatic
- It is highly recommended to use the carpet when placing the Silent Room on hard flooring
- If you are planning to place the Silent Room on your carpet, you do not need to order the additional carpet
- Uneven floor can be the cause of sound insulation problems

ELECTRICAL (M / L / XL)

Power socket (ARU704)

- 1 AC power socket 100-240 V
- Integrated USB fast charger (USB Type A+C, max 5A)
- 1 cable guide for multimedia cable
- Mounting in Ø80mm cut-out
- Dimensions: Ø90x66 mm
- Cable length: 0.8m

Power socket (ARU703)

- 1 AC power socket 100-240 V
- Dimensions: 90x66 mm
- Mounting in Ø80mm cut-out
- Cable length: 0.8m

Power socket block set for media (ZZZ336)

- 3 AC power sockets 100-240 V
- Dimensions: 260x60x45 mm
- Adaptor block GST18i3 T-type - 1 x male, 2 x female
- Extension cable length: 0.5m - GST18i3 male to GST18i3 female

Power unit for media wall (ZZZ340)

- 3 AC power sockets 100-240 V
- Dimensions: 260x60x45 mm
- Metal frame 317x119x40 mm, made from 2mm powder coated metal sheet
- Mounting in 300x110mm cut-out
- Extension cable length: 1m - GST18i3 male to GST18i3 female

Power unit for media wall (ZZZ341)

- 2 AC power sockets 100-240 V
- 1 LAN outlet (CAT6 RJ45) with 2m flylead
- Dimensions: 260x60x45 mm
- Powder coated metal frame 317x119x40 mm, made from 2mm metal sheet
- Mounting in 300x110 mm cut-out
- Extension cable length: 1 m - GST18i3 male to GST18i3 female

Power unit for media wall (ZZZ342)

- 2 AC power sockets 100-240 V
- 1 Integrated USB fast charger (Type A+C, max 5A)
- Dimensions: 260x60x45 mm
- Powder coated metal frame 317x119x40 mm, made from 2mm metal sheet
- Mounting in 300x110 mm cut-out
- Extension cable length: 1m - GST18i3 male to GST18i3 female

Power unit for media wall (ZZZ343)

- 1 AC power sockets 100-240 V
- 1 Integrated USB fast charger (Type A+C, max 5A)
- 1 LAN outlet (CAT6 RJ45) with 2m flylead
- Dimensions: 260x60x45 mm
- Powder coated metal frame 317x119x40 mm, made from 2mm metal sheet
- Mounting in 300x110 mm cut-out
- Extension cable length: 1m - GST18i3 male to GST18i3 female

Materials

Band A Fabric*

Berta

Band B Fabric*

Step/Step Melange

Band C Fabric*

Velito Presto
Camira Synergy

Band A MFC

Whitened Oak (D1)
Amber Oak (D2)
White (M1)
Dark Grey (N1)
Pearl Grey (N3)

Band B MFC

Sand Ash (D3)
Dark Walnut (D4)
Grey Wood (D5)
Cubanit Grey (N2)
Black (J4)

Metal

Black (A)

Glass

Clear Glass (1)

Range

Silent Room S*

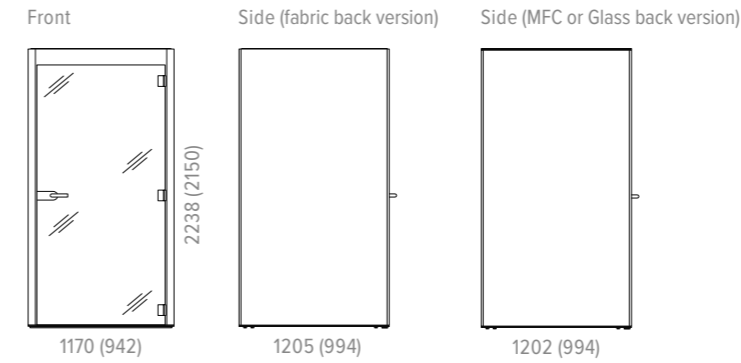

Total height with floor: 2306mm
External (Internal)

Fabric + fabric back: 305kg
MFC + MFC back: 315kg
Fabric + glass back: 302kg
MFC + glass back: 308kg

Silent Room M*

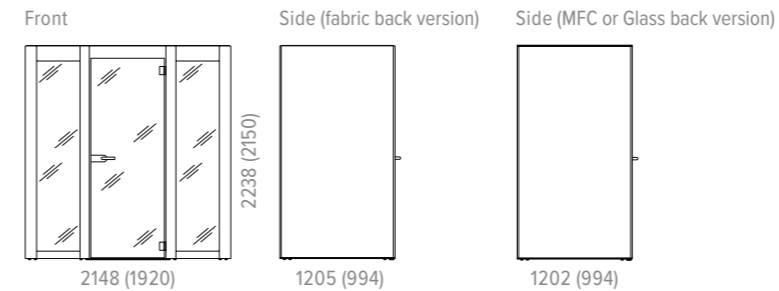

Total height with floor: 2306mm
External (Internal)

Fabric + fabric back: 458kg
MFC + MFC back: 472kg
Fabric + glass back: 448kg
MFC + glass back: 454kg

Silent Room L*

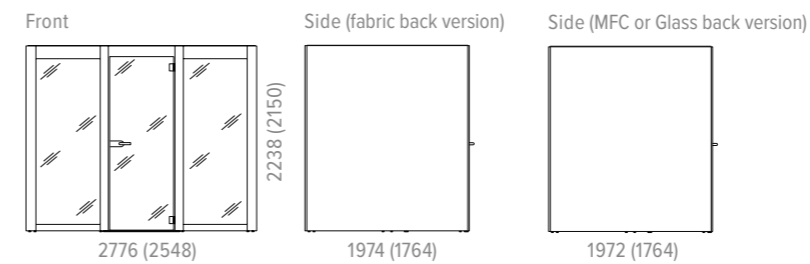

Total height with floor: 2306mm
External (Internal)

Fabric + fabric back: 683kg
MFC + MFC back: 704kg
Fabric + glass back: 675kg
MFC + glass back: 685kg

Silent Room XL*

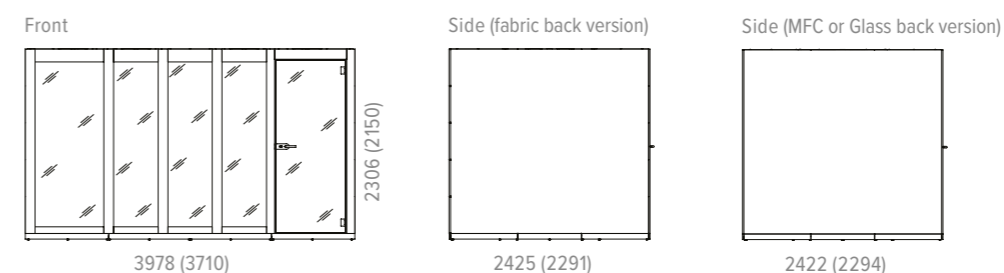

Total height with floor: 2306mm
External (Internal)

Fabric + fabric back: 1310kg
MFC + MFC back: 1365kg
Fabric + glass back: 1292kg
MFC + glass back: 1315kg

Silent Room S

STEP 1	STEP 2	STEP 3	STEP 4	STEP 5	STEP 6
Choose external walls (fabric or MFC)	Choose side internal walls (fabric)	Choose front internal walls (fabric or MFC)	Choose central internal wall (MFC)	Choose glass door frame R/H or L/H	Add ceiling + optional accessories

G1: Band A Fabric			G2: Band B Fabric			G3: Band C Fabric		
-------------------	--	--	-------------------	--	--	-------------------	--	--

STEP 1	CODE	DESCRIPTION	WIDTH	DEPTH	HEIGHT	G1 (£)	G2 (£)	G3 (£)
--------	------	-------------	-------	-------	--------	--------	--------	--------



AR1101	Silent Room S / Step 1 option External walls, upholstered with fabric	1170	1189	2235	2,879	3,717	4,434
--------	--	------	------	------	--------------	--------------	--------------

G1: Band A MFC			G2: Band B MFC		
----------------	--	--	----------------	--	--

STEP 1	CODE	DESCRIPTION	WIDTH	DEPTH	HEIGHT	G1 (£)	G2 (£)
--------	------	-------------	-------	-------	--------	--------	--------



AR1102	Silent Room S / Step 1 option External MFC walls	1170	1186	2235	1,752	1,989
--------	---	------	------	------	--------------	--------------

G1: Band A Fabric + Band A MFC		G3: Band B Fabric + Band A MFC		G5: Band C Fabric + Band A MFC	
G2: Band A Fabric + Band B MFC		G4: Band B Fabric + Band B MFC		G6: Band C Fabric + Band B MFC	

STEP 1	CODE	DESCRIPTION	WIDTH	DEPTH	HEIGHT	G1 (£)	G2 (£)	G3 (£)	G4 (£)	G5 (£)	G6 (£)
--------	------	-------------	-------	-------	--------	--------	--------	--------	--------	--------	--------



AR1103	Silent Room S / Step 1 option External walls, upholstered with fabric, rear wall with glass / MFC	1170	1186	2235	3,573	3,650	4,134	4,211	4,620	4,697
--------	--	------	------	------	--------------	--------------	--------------	--------------	--------------	--------------

G1: Band A MFC			G2: Band B MFC		
----------------	--	--	----------------	--	--

STEP 1	CODE	DESCRIPTION	WIDTH	DEPTH	HEIGHT	G1 (£)	G2 (£)
--------	------	-------------	-------	-------	--------	--------	--------



AR1104	Silent Room S / Step 1 option External MFC walls, rear wall with glass	1170	1186	2235	2,843	3,080
--------	---	------	------	------	--------------	--------------

G1: Band A Fabric		G2: Band B Fabric			G3: Band C Fabric		
-------------------	--	-------------------	--	--	-------------------	--	--

STEP 2	CODE	DESCRIPTION	WIDTH	DEPTH	HEIGHT	G1 (£)	G2 (£)	G3 (£)
--------	------	-------------	-------	-------	--------	--------	--------	--------

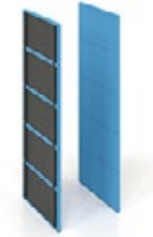

AR1201	Silent Room S / Step 2 Internal acoustic side walls, upholstered with fabric	1090	76	2150	1,807	2,249	2,574
--------	---	------	----	------	--------------	--------------	--------------

G1: Band A Fabric		G2: Band B Fabric			G3: Band C Fabric		
-------------------	--	-------------------	--	--	-------------------	--	--

STEP 3	CODE	DESCRIPTION	WIDTH	DEPTH	HEIGHT	G1 (£)	G2 (£)	G3 (£)
--------	------	-------------	-------	-------	--------	--------	--------	--------



AR1301	Silent Room S / Step 3 option Internal front walls, upholstered with fabric <i>Not required with glass rear wall (Step 1)</i>	218	39	2150	404	531	658
--------	---	-----	----	------	------------	------------	------------

G1: Band A MFC			G2: Band B MFC		
----------------	--	--	----------------	--	--

STEP 3	CODE	DESCRIPTION	WIDTH	DEPTH	HEIGHT	G1 (£)	G2 (£)
--------	------	-------------	-------	-------	--------	--------	--------



AR1302	Silent Room S / Step 3 option Internal front MFC walls <i>Not required with glass rear wall (Step 1)</i>	218	36	2150	229	257
--------	--	-----	----	------	------------	------------

G1: Band A MFC			G2: Band B MFC		
----------------	--	--	----------------	--	--



STEP 4	CODE	DESCRIPTION	WIDTH	DEPTH	HEIGHT	G1 (£)	G2 (£)
--------	------	-------------	-------	-------	--------	--------	--------







ARU401	Silent Room S / Step 4 option Internal front central wall with ventilation and LED lighting control system, table (300x500, H146mm) mountable on media wall with power socket and integrated USB-A & USB-C fast charger, with one cable guide, tabletop H1050mm from the ground	500	396	2150	5,359	5,402
--------	--	-----	-----	------	--------------	--------------



ARU402	Silent Room S / Step 4 option Internal front central wall with ventilation and LED lighting control system, table (300x500, H146mm) mountable on media wall with power socket, tabletop H1050mm from the ground	500	396	2150	4,754	4,799
--------	--	-----	-----	------	--------------	--------------

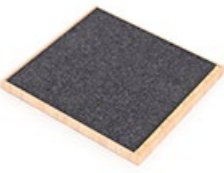

		G1: Band A MFC			G2: Band B MFC		
STEP 5	CODE	DESCRIPTION	WIDTH	DEPTH	HEIGHT	G1 (£)	G2 (£)
	ARU511	Silent Room S / Step 5 option R/H glass door in metal frame with MFC front cover, 8mm tempered safety glass, door handle without lock	1170	56	2235	3,215	3,260
	ARU512	Silent Room S / Step 5 option L/H glass door in metal frame with MFC front cover, 8mm tempered safety glass, door handle without lock	1170	56	2235	3,215	3,260

STEP 6	CODE	DESCRIPTION	WIDTH	DEPTH	HEIGHT	RSP (£)
	AR1602	Silent Room S / Step 6 MFC ceiling with LED light and ventilation (air extraction) system	1085	1140	118.5	2,061
	AR1701	Carpet <i>Optional</i>	1040	1080	8.5	444
	ARU701	Autonomous smoke alarm device <i>Optional</i>	110	110	39	344
	ARU702	Smoke alarm device for fire alarm system <i>Optional</i>	104	104	35	135

		G1: Band A MFC			G2: Band B MFC		
STEP 6	CODE	DESCRIPTION	WIDTH	DEPTH	HEIGHT	G1 (£)	G2 (£)
	AR1702	MFC floor covered with carpet, metal frame structure <i>Optional</i>	1167	1203	78	1,204	1,210

Preconfigured pod ideas

		G1: Band A Fabric + Band A MFC Media Wall			G2: Band B Fabric + Band A MFC Media Wall			G3: Band C Fabric + Band A MFC Media Wall		
	CODE	DESCRIPTION	WIDTH	DEPTH	HEIGHT	G1 (£)	G2 (£)	G3 (£)		
	ARK101	Silent Room S with upholstered external and internal walls, internal front central wall with control system, glass doors and MFC ceiling	1170	1205	2238	17,041	18,691	20,078		

		G1: Band A MFC + Band A Fabric Internal Walls			G2: Band B MFC + Band B Fabric Internal Walls		
	CODE	DESCRIPTION	WIDTH	DEPTH	HEIGHT	G1 (£)	G2 (£)
	ARK102	Silent Room S with MFC external and upholstered internal walls, internal front central wall with control system, glass doors and MFC ceiling	1170	1202	2238	15,697	16,635
	ARK104	Silent Room S with MFC external walls and rear panel with glass, upholstered internal walls, internal front central wall with control system, glass doors and MFC ceiling	1170	1202	2238	16,544	17,329

		G1: Band A Fabric + Band A MFC G2: Band A Fabric + Band B MFC		G3: Band B Fabric + Band A MFC G4: Band B Fabric + Band B MFC		G5: Band C Fabric + Band A MFC G6: Band C Fabric + Band B MFC					
	CODE	DESCRIPTION	WIDTH	DEPTH	HEIGHT	G1 (£)	G2 (£)	G3 (£)	G4 (£)	G5 (£)	G6 (£)
	ARK103	Silent Room S with upholstered external walls and rear panel with glass, upholstered internal walls, internal front central wall with control system, glass doors and MFC ceiling	1170	1205	2238	17,415	17,507	18,587	18,679	19,557	19,648

Silent Room M

STEP 1	STEP 2	STEP 3	STEP 4	STEP 5	STEP 6
Choose external walls (fabric or MFC)	Choose side internal walls (fabric)	Choose front internal walls (fabric or MFC)	Choose central internal wall (MFC)	Choose glass door frame R/H or L/H	Add ceiling + optional floor & seating

G1: Band A Fabric		G2: Band B Fabric			G3: Band C Fabric			
STEP 1	CODE	DESCRIPTION	WIDTH	DEPTH	HEIGHT	G1 (£)	G2 (£)	G3 (£)
	AR2101	Silent Room M / Step 1 option External walls, upholstered with fabric	2148	1189	2235	3,985	5,365	6,515

		G1: Band A MFC			G2: Band B MFC		
STEP 1	CODE	DESCRIPTION	WIDTH	DEPTH	HEIGHT	G1 (£)	G2 (£)
	AR2102	Silent Room M / Step 1 option External MFC walls	2148	1186	2235	2,605	2,952

G1: Band A Fabric + Band A MFC G2: Band A Fabric + Band B MFC		G3: Band B Fabric + Band A MFC G4: Band B Fabric + Band B MFC			G5: Band C Fabric + Band A MFC G6: Band C Fabric + Band B MFC						
STEP 1	CODE	DESCRIPTION	WIDTH	DEPTH	HEIGHT	G1 (£)	G2 (£)	G3 (£)	G4 (£)	G5 (£)	G6 (£)
	AR2103	Silent Room M / Step 1 option External walls, upholstered with fabric, rear wall with glass / MFC	2148	1186	2235	4,924	5,046	5,512	5,634	6,021	6,143

		G1: Band A MFC			G2: Band B MFC		
STEP 1	CODE	DESCRIPTION	WIDTH	DEPTH	HEIGHT	G1 (£)	G2 (£)
	AR2104	Silent Room M / Step 1 option External MFC walls, rear wall with glass / MFC	2148	1186	2235	4,167	4,450

G1: Band A Fabric		G2: Band B Fabric			G3: Band C Fabric			
STEP 2	CODE	DESCRIPTION	WIDTH	DEPTH	HEIGHT	G1 (£)	G2 (£)	G3 (£)
	AR1201	Silent Room M / Step 2 Internal acoustic side walls, upholstered with fabric	1090	76	2150	1,807	2,249	2,574



G1: Band A Fabric		G2: Band B Fabric			G3: Band C Fabric			
STEP 3	CODE	DESCRIPTION	WIDTH	DEPTH	HEIGHT	G1 (£)	G2 (£)	G3 (£)
	AR2301	Silent Room M / Step 3 option Internal front walls, upholstered with fabric <i>Not required with glass rear wall (Step 1)</i>	607	39	2150	979	1,487	1,915



		G1: Band A MFC			G2: Band B MFC		
STEP 3	CODE	DESCRIPTION	WIDTH	DEPTH	HEIGHT	G1 (£)	G2 (£)
	AR2302	Silent Room M / Step 3 option Internal front MFC walls <i>Not required with glass rear wall (Step 1)</i>	607	36	2150	527	636

		G1: Band A MFC			G2: Band B MFC		
STEP 4	CODE	DESCRIPTION	WIDTH	DEPTH	HEIGHT	G1 (£)	G2 (£)
	ARU410	Silent Room M / Step 4 option Internal front central wall with cut-out for power socket and electronic control system. Cable guides are on both sides of the wall <i>S1-1P3C(1A/2C)1D1H must be ordered</i>	700	96	2150	6,142	6,194





	ARU403	Silent Room M / Step 4 option Internal front central wall with table (H=720 mm), VESA mount and electronic control system <i>S1-1P3C(1A/2C)1D1H and SRPK must be ordered</i>	700	696	2150	7,464	7,528
---	--------	--	-----	-----	------	--------------	--------------





	ARU411	Silent Room M / Step 4 option Internal front central wall with table (H=1050 mm), VESA mount and electronic control system <i>S1-1P3C(1A/2C)1D1H and SRPK must be ordered</i>	700	696	2150	7,464	7,528
---	--------	---	-----	-----	------	--------------	--------------



STEP 4	CODE	DESCRIPTION	G1: Band A MFC			G2: Band B MFC	
			WIDTH	DEPTH	HEIGHT	G1 (£)	G2 (£)
	ARU412	Silent Room M / Step 4 option Internal front central wall with cut-out for power unit and electronic control system. Cable guides are on both sides of the wall <i>ZZZ340, ZZZ341, ZZZ342 or ZZZ343 must be ordered</i>	700	96	2150	6,142	6,194
	ARU413	Silent Room M / Step 4 option Internal front central wall with table (H=720 mm), VESA mount and electronic control system <i>ZZZ340, ZZZ341, ZZZ342 or ZZZ343 and SRPK must be ordered</i>	700	696	2150	7,464	7,528
	ARU414	Silent Room M / Step 4 option Internal front central wall with table (H=1050 mm), VESA mount and electronic control system <i>ZZZ340, ZZZ341, ZZZ342 or ZZZ343 and SRPK must be ordered</i>	700	696	2150	7,464	7,528

STEP 4	CODE	DESCRIPTION	WIDTH	DEPTH	HEIGHT	RSP (£)
	S1-1P3C(1A/2C)1D1H-BK	Metalicon Solo Plus power socket with integrated 18W USB-A & 45W USB-C smart charge, 1 x HDMI data transfer port and 1 x Cat6 RJ45 data transfer port, black. <i>Required for internal front central walls with cut-out ARU410, ARU403, ARU411</i>	Ø110		65	182
	SRPK	Powerlink power module, 3 power sockets, with 1m extension cable (GST male to GST female) and adaptor block (1 x GST male, 2 x GST female) <i>Required for internal front central walls with tv screen ARU403, ARU411, ARU413, ARU414</i>	264	70	60	74





STEP 4	CODE	DESCRIPTION	WIDTH	DEPTH	HEIGHT	RSP (£)
	ZZZ340	Power module (3 x power sockets) for media wall	317	119	45	397
	ZZZ341	Power module (2 x power sockets and 1 x RJ45 socket) for internal front central wall	317	119	45	453
	ZZZ342	Power module (2 x power sockets, USB-A & USB-C fast charger) for internal front central wall	317	119	45	815
	ZZZ343	Power module (1 x power socket, USB-A & USB-C fast charger, 1 x RJ45 socket) for internal front central wall	317	119	45	932

STEP 5	CODE	DESCRIPTION	G1: Band A MFC			G2: Band B MFC	
			WIDTH	DEPTH	HEIGHT	G1 (£)	G2 (£)
	ARU521	Silent Room M / Step 5 option R/H glass facade with doors in metal frame with MFC front cover, 8mm tempered safety glass, door handle without lock	2148	56	2235	6,543	6,651
	ARU522	Silent Room M / Step 5 option L/H glass facade with doors in metal frame with MFC front cover, 8mm tempered safety glass, door handle without lock	2148	56	2235	6,543	6,651
	ARU523	Silent Room M / Step 5 option R/H glass facade with doors in metal frame with MFC front cover, 8mm tempered safety glass, door handle with lock	2148	56	2235	6,730	6,835
	ARU524	Silent Room M / Step 5 option L/H glass facade with doors in metal frame with MFC front cover, 8mm tempered safety glass, door handle with lock	2148	56	2235	6,730	6,835

STEP 6	CODE	DESCRIPTION	WIDTH	DEPTH	HEIGHT	RSP (£)
	AR2602	Silent Room M / Step 6 MFC ceiling with LED light and ventilation (air extraction) system	2102	1165	78	3,410
	AR2701	Carpet <i>Optional</i>	1950	1095	6.5	1,027



		G1: Band A MFC	G2: Band B MFC				
STEP 6	CODE	DESCRIPTION	WIDTH	DEPTH	HEIGHT	G1 (£)	G2 (£)
	AR2702	MFC floor covered with carpet, metal frame structure <i>Optional</i>	2145	1203	78	2,204	2,216

		G1: Band A Fabric	G2: Band B Fabric		G3: Band C Fabric			
STEP 6	CODE	DESCRIPTION	WIDTH	DEPTH	HEIGHT	G1 (£)	G2 (£)	G3 (£)
	ARS100	Pouf with backrest (1000x600, H300), black MFC base and plastic supports, H440mm seat <i>Optional</i>	1000	600	740	1,043	1,355	1,608

STEP 6	CODE	DESCRIPTION	WIDTH	DEPTH	HEIGHT	RSP (£)
	ARU701	Autonomous smoke alarm <i>Optional</i>	110	110	39	344
	ARU702	Smoke alarm for fire alarm system <i>Optional</i>	104	104	35	135

Preconfigured pod ideas

		G1: Band A Fabric + Band A MFC Media Wall	G2: Band B Fabric + Band A MFC Media Wall		G3: Band C Fabric + Band A MFC Media Wall			
	CODE	DESCRIPTION	WIDTH	DEPTH	HEIGHT	G1 (£)	G2 (£)	G3 (£)
	ARK201	Silent Room M with upholstered external and internal walls, internal front central wall with control system, glass doors and MFC ceiling, poufs with backrest (2 pcs.)	2148	1205	2238	28,361	31,767	34,565

		G1: Band A MFC + Band A Fabric Internal Walls	G2: Band B MFC + Band B Fabric Internal Walls				
	CODE	DESCRIPTION	WIDTH	DEPTH	HEIGHT	G1 (£)	G2 (£)
	ARK202	Silent Room M with MFC external and upholstered internal walls, internal front central wall with control system, glass doors, MFC ceiling, poufs with backrest (2 pcs.)	2148	1202	2238	26,681	28,914
	ARK204	Silent Room M with upholstered external walls and rear panel with glass, upholstered internal walls, internal front central wall with control system, glass doors and MFC ceiling, poufs with backrest (2 pcs.)	2148	1202	2238	27,515	29,074

		G1: Band A Fabric + Band A MFC G2: Band A Fabric + Band B MFC	G3: Band B Fabric + Band A MFC G4: Band B Fabric + Band B MFC		G5: Band C Fabric + Band A MFC G6: Band C Fabric + Band B MFC						
	CODE	DESCRIPTION	WIDTH	DEPTH	HEIGHT	G1 (£)	G2 (£)	G3 (£)	G4 (£)	G5 (£)	G6 (£)
	ARK203	Silent Room M with MFC external walls and rear panel with glass, upholstered internal walls, internal front central wall with control system, glass doors, MFC ceiling, poufs with backrest (2 pcs.)	2148	1205	2238	28,386	28,539	30,270	30,424	31,829	31,982

Silent Room L

STEP 1	STEP 2	STEP 3	STEP 4	STEP 5	STEP 6
Choose external walls (fabric or MFC)	Choose side internal walls (fabric)	Choose front internal walls (fabric or MFC)	Choose central internal wall (MFC)	Choose glass door frame R/H or L/H	Add ceiling + optional floor & accessories

G1: Band A Fabric		G2: Band B Fabric			G3: Band C Fabric			
STEP 1	CODE	DESCRIPTION	WIDTH	DEPTH	HEIGHT	G1 (£)	G2 (£)	G3 (£)
	AR4101	Silent Room L / Step 1 option External walls, upholstered with fabric	2776	1959	2235	5,552	7,412	8,957

G1: Band A MFC		G2: Band B MFC					
STEP 1	CODE	DESCRIPTION	WIDTH	DEPTH	HEIGHT	G1 (£)	G2 (£)
	AR4102	Silent Room L / Step 1 option External MFC walls	2776	1956	2235	4,142	4,721

G1: Band A Fabric + Band A MFC G2: Band A Fabric + Band B MFC		G3: Band B Fabric + Band A MFC G4: Band B Fabric + Band B MFC			G5: Band C Fabric + Band A MFC G6: Band C Fabric + Band B MFC						
STEP 1	CODE	DESCRIPTION	WIDTH	DEPTH	HEIGHT	G1 (£)	G2 (£)	G3 (£)	G4 (£)	G5 (£)	G6 (£)
	AR4103	Silent Room L / Step 1 option External walls, upholstered with fabric, rear wall with glass / MFC	2776	1959	2235	7,348	7,469	8,410	8,532	9,280	9,401

G1: Band A MFC		G2: Band B MFC					
STEP 1	CODE	DESCRIPTION	WIDTH	DEPTH	HEIGHT	G1 (£)	G2 (£)
	AR4104	Silent Room L / Step 1 option External MFC walls, rear wall with glass / MFC	2776	1956	2235	6,511	6,976

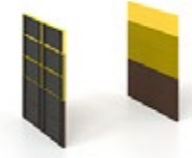
G1: Band A Fabric		G2: Band B Fabric			G3: Band C Fabric			
STEP 2	CODE	DESCRIPTION	WIDTH	DEPTH	HEIGHT	G1 (£)	G2 (£)	G3 (£)
	AR4201	Silent Room L / Step 2 Internal acoustic side walls, upholstered with fabric	930	76	2150	4,574	5,720	6,632



G1: Band A Fabric		G2: Band B Fabric			G3: Band C Fabric			
STEP 3	CODE	DESCRIPTION	WIDTH	DEPTH	HEIGHT	G1 (£)	G2 (£)	G3 (£)
	AR4301	Silent Room L / Step 3 option Internal front walls, upholstered with fabric <i>Not required with glass rear wall (Step 1)</i>	871	39	2150	1,272	1,822	2,310



G1: Band A MFC		G2: Band B MFC					
STEP 3	CODE	DESCRIPTION	WIDTH	DEPTH	HEIGHT	G1 (£)	G2 (£)
	AR4302	Silent Room L / Step 3 option Internal front MFC walls <i>Not required with glass rear wall (Step 1)</i>	871	36	2150	734	879

G1: Band A MFC		G2: Band B MFC					
STEP 4	CODE	DESCRIPTION	WIDTH	DEPTH	HEIGHT	G1 (£)	G2 (£)
	ARU404	Silent Room L / Step 4 option Internal front central wall with cut-out for power socket and electronic control system, cable guides are on both sides of the wall <i>S1-1P3C(1A/2C)1D1H must be ordered</i>	800	96	2150	5,782	5,837





G1: Band A MFC		G2: Band B MFC					
STEP 4	CODE	DESCRIPTION	WIDTH	DEPTH	HEIGHT	G1 (£)	G2 (£)
	ARU405	Silent Room L / Step 4 option Internal front central wall with table (H720 mm), VESA mount and electronic control system <i>S1-1P3C(1A/2C)1D1H and SRPK must be ordered</i>	800	1296	2150	6,999	7,090





G1: Band A MFC		G2: Band B MFC					
STEP 4	CODE	DESCRIPTION	WIDTH	DEPTH	HEIGHT	G1 (£)	G2 (£)
	ARU406	Silent Room L / Step 4 option Internal front central wall with table (H1050 mm), VESA mount and electronic control system <i>S1-1P3C(1A/2C)1D1H and SRPK must be ordered</i>	800	1296	2150	7,012	7,103





STEP 4	CODE	DESCRIPTION				G1: Band A MFC		G2: Band B MFC	
			WIDTH	DEPTH	HEIGHT	G1 (£)	G2 (£)		
	ARU407	Silent Room L / Step 4 option Internal front central wall with cut-out for power unit and electronic control system, cable guides are on both sides of the wall <i>ZZZ340, ZZZ341, ZZZ342 or ZZZ343 must be ordered</i>	800	96	2150	5,782	5,837		
	ARU408	Silent Room L / Step 4 option Internal front central wall with table (H720mm), VESA mount and electronic control system <i>ZZZ340, ZZZ341, ZZZ342 or ZZZ343 and SRPK must be ordered</i>	800	1296	2150	6,999	7,090		
	ARU409	Silent Room L / Step 4 option Internal front central wall with table (H1050mm), VESA mount and electronic control system <i>ZZZ340, ZZZ341, ZZZ342 or ZZZ343 SRPK must be ordered</i>	800	1296	2150	7,011	7,101		

STEP 4	CODE	DESCRIPTION	WIDTH	DEPTH	HEIGHT	RSP (£)
	S1-1P3C(1A/2C)1D1H	Metalicon Solo Plus power socket with integrated 18W USB-A & 45W USB-C smart charge, 1 x HDMI data transfer port and 1 x Cat6 RJ45 data transfer port, black. <i>Required for internal front central walls with cut-out ARU404, ARU405, ARU406</i>	Ø110		65	182
	SRPK	Powerlink power module, 3 power sockets, with 1m extension cable (GST male to GST female) and adaptor block (1 x GST male, 2 x GST female) <i>Required for internal front central walls with tv screen ARU403, ARU411, ARU413, ARU414</i>	264	70	60	74



STEP 4	CODE	DESCRIPTION	WIDTH	DEPTH	HEIGHT	RSP (£)
	ZZZ340	Power module (3 x power sockets) for internal front central wall	317	119	45	397
	ZZZ341	Power module (2 x power sockets and 1 x RJ45 socket) for internal front central wall	317	119	45	453
	ZZZ342	Power module (2 x power sockets, USB-A & USB-C fast charger) for internal front central wall	317	119	45	815
	ZZZ343	Power module (1 x power socket, USB-A & USB-C fast charger, 1 x RJ45 socket) for internal front central wall	317	119	45	932

STEP 5	CODE	DESCRIPTION				G1: Band A MFC		G2: Band B MFC	
			WIDTH	DEPTH	HEIGHT	G1 (£)	G2 (£)		
	ARU541	Silent Room L / Step 5 option R/H glass facade with doors in metal frame with MFC front cover, 8mm tempered safety glass, door handle without lock	2776	56	2235	7,165	7,263		
	ARU542	Silent Room L / Step 5 option L/H glass facade with doors in metal frame with MFC front cover, 8mm tempered safety glass, door handle without lock	2776	56	2235	7,165	7,263		
	ARU543	Silent Room L / Step 5 option R/H glass facade with doors in metal frame with MFC front cover, 8mm tempered safety glass, door handle with lock	2776	56	2235	7,351	7,438		
	ARU544	Silent Room L / Step 5 option L/H glass facade with doors in metal frame with MFC front cover, 8mm tempered safety glass, door handle with lock	2776	56	2235	7,351	7,438		

STEP 6	CODE	DESCRIPTION	WIDTH	DEPTH	HEIGHT	RSP (£)
	AR4602	Silent Room L / Step 6 MFC ceiling with LED light and ventilation (air extraction) system	2694	1910	118.5	4,195
	AR4701	Carpet <i>Optional</i>	2580	1865	8.5	1,889
	ARU701	Autonomous smoke alarm <i>Optional</i>	110	110	39	344
	ARU702	Smoke alarm for fire alarm system <i>Optional</i>	104	104	35	135

G1: Band A MFC G2: Band B MFC

STEP 6	CODE	DESCRIPTION	WIDTH	DEPTH	HEIGHT	G1 (£)	G2 (£)
	AR4702	MFC floor covered with carpet, metal frame structure <i>Optional</i>	2773	1973	78	4,155	4,192





Preconfigured pod ideas

G1: Band A Fabric + Band A MFC Media Wall G2: Band B Fabric + Band A MFC Media Wall G3: Band C Fabric + Band A MFC Media Wall

	CODE	DESCRIPTION	WIDTH	DEPTH	HEIGHT	G1 (£)	G2 (£)	G3 (£)
	ARK401	Silent Room L with upholstered external and internal walls, internal front central wall with control system, glass doors and MFC ceiling	2776	1975	2238	34,129	38,295	41,763

G1: Band A MFC + Band A Fabric Internal Walls G2: Band B MFC + Band B Fabric Internal Walls

	CODE	DESCRIPTION	WIDTH	DEPTH	HEIGHT	G1 (£)	G2 (£)
	ARK402	Silent Room L with MFC external and upholstered internal walls, internal front central wall with control system, glass doors and MFC ceiling	2776	1972	2238	32,411	35,068

	ARK404	Silent Room L with MFC external walls and rear panel with glass, upholstered internal walls, internal front central wall with control system, glass doors and MFC ceiling	2776	1972	2238	33,872	35,743
---	--------	---	------	------	------	---------------	---------------

G1: Band A Fabric + Band A MFC G3: Band B Fabric + Band A MFC G5: Band C Fabric + Band A MFC
G2: Band A Fabric + Band B MFC G4: Band B Fabric + Band B MFC G6: Band C Fabric + Band B MFC

	CODE	DESCRIPTION	WIDTH	DEPTH	HEIGHT	G1 (£)	G2 (£)	G3 (£)	G4 (£)	G5 (£)	G6 (£)
	ARK403	Silent Room L with upholstered external walls and rear panel with glass, upholstered internal walls, internal front central wall with control system, glass doors and MFC ceiling	2776	1975	2238	34,853	34,994	37,443	37,584	39,535	39,676

Silent Room XL

STEP 1	STEP 2	STEP 3	STEP 4	STEP 5	STEP 6
Choose external walls (fabric or MFC)	Choose side internal walls (fabric)	Choose front internal walls (fabric or MFC)	Choose central internal wall (MFC)	Choose glass door frame R/H or L/H	Add ceiling + optional floor & accessories

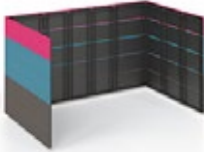
G1: Band A Fabric		G2: Band B Fabric			G3: Band C Fabric			
STEP 1	CODE	DESCRIPTION	WIDTH	DEPTH	HEIGHT	G1 (£)	G2 (£)	G3 (£)
	AR8101	Silent Room XL / Step 1 option External walls, upholstered with fabric	3978	2409	2225	10,579	13,506	15,979

G1: Band A MFC		G2: Band B MFC					
STEP 1	CODE	DESCRIPTION	WIDTH	DEPTH	HEIGHT	G1 (£)	G2 (£)
	AR8102	Silent Room XL / Step 1 option External MFC walls	3978	2406	2225	8,413	8,586

G1: Band A Fabric + Band A MFC G2: Band A Fabric + Band B MFC		G3: Band B Fabric + Band A MFC G4: Band B Fabric + Band B MFC			G5: Band C Fabric + Band A MFC G6: Band C Fabric + Band B MFC						
STEP 1	CODE	DESCRIPTION	WIDTH	DEPTH	HEIGHT	G1 (£)	G2 (£)	G3 (£)	G4 (£)	G5 (£)	G6 (£)
	AR8103	Silent Room XL / Step 1 option External walls, upholstered with fabric, rear wall with glass / MFC	3978	2406	2225	15,077	15,156	16,685	16,764	18,023	18,102

G1: Band A MFC		G2: Band B MFC					
STEP 1	CODE	DESCRIPTION	WIDTH	DEPTH	HEIGHT	G1 (£)	G2 (£)
	AR8104	Silent Room XL / Step 1 option External MFC walls, rear wall with glass / MFC	2776	1956	2235	13,874	14,052

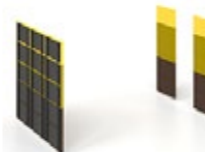
G1: Band A Fabric		G2: Band B Fabric			G3: Band C Fabric			
STEP 2	CODE	DESCRIPTION	WIDTH	DEPTH	HEIGHT	G1 (£)	G2 (£)	G3 (£)
	AR8201	Silent Room XL / Step 2 Internal acoustic side walls, upholstered with fabric	770	76	2150	5,211	6,671	7,911





G1: Band A Fabric		G2: Band B Fabric			G3: Band C Fabric			
STEP 3	CODE	DESCRIPTION	WIDTH	DEPTH	HEIGHT	G1 (£)	G2 (£)	G3 (£)
	AR8301	Silent Room XL / Step 3 option Internal front walls, upholstered with fabric <i>Not required with glass rear wall (Step 1)</i>	3745	39	2150	3,413	4,940	6,045

G1: Band A MFC		G2: Band B MFC					
STEP 3	CODE	DESCRIPTION	WIDTH	DEPTH	HEIGHT	G1 (£)	G2 (£)
	AR8302	Silent Room XL / Step 3 option Internal front MFC walls <i>Not required with glass rear wall (Step 1)</i>	3745	36	2150	2,345	2,425

G1: Band A MFC		G2: Band B MFC					
STEP 4	CODE	DESCRIPTION	WIDTH	DEPTH	HEIGHT	G1 (£)	G2 (£)
	ARU415	Silent Room XL / Step 4 option Internal front central wall with cut-out for power unit and electronic control system. Cable guides are on both sides of the wall. <i>ZZZ340, ZZZ341, ZZZ342 or ZZZ343 must be ordered</i>	770	96	2150	6,818	6,868



	ARU416	Silent Room XL / Step 4 option Internal front central wall with table (H=720 mm), VESA mount and electronic control system. <i>ZZZ340, ZZZ341, ZZZ342 or ZZZ343 and SRPK must be ordered</i>	770	2446	2150	7,634	7,744
---	--------	--	-----	------	------	-------	-------



	ARU417	Silent Room XL / Step 4 option Internal front central wall with table (H=1050 mm), VESA mount and electronic control system. <i>ZZZ340, ZZZ341, ZZZ342 or ZZZ343 and SRPK must be ordered</i>	770	2446	2150	7,695	7,806
---	--------	---	-----	------	------	-------	-------



STEP 4	CODE	DESCRIPTION	WIDTH	DEPTH	HEIGHT	RSP (£)
	ZZZ340	Power module (3 x power sockets) for media wall	317	119	45	397
	ZZZ341	Power module (2 x power sockets and 1 x RJ45 socket) for internal front central wall	317	119	45	453
	ZZZ342	Power module (2 x power sockets, USB-A & USB-C fast charger) for internal front central wall	317	119	45	815
	ZZZ343	Power module (1 x power socket, USB-A & USB-C fast charger, 1 x RJ45 socket) for internal front central wall	317	119	45	932

STEP 4	CODE	DESCRIPTION	WIDTH	DEPTH	HEIGHT	RSP (£)
	SRPK	Powerlink power module, 3 power sockets, with 1m extension cable (GST male to GST female) and adaptor block (1 x GST male, 2 x GST female) <i>Required for internal front central walls with tv screen ARU403, ARU411, ARU413, ARU414</i>	264	70	60	74

G1: Band A MFC G2: Band B MFC

STEP 5	CODE	DESCRIPTION	WIDTH	DEPTH	HEIGHT	G1 (£)	G2 (£)
	ARU581	Silent Room XL / Step 5 R/H glass facade with doors in metal frame with MFC front cover, 8mm tempered safety glass, door handle without lock	3978	56	2225	11,475	11,525
	ARU582	Silent Room XL / Step 5 L/H glass facade with doors in metal frame with MFC front cover, 8mm tempered safety glass, door handle without lock	3978	56	2225	11,475	11,525





				G1: Band A MFC		G2: Band B MFC	
STEP 5	CODE	DESCRIPTION	WIDTH	DEPTH	HEIGHT	G1 (£)	G2 (£)
	ARU583	Silent Room XL / Step 5 option R/H glass facade with doors in metal frame with MFC front cover, 8mm tempered safety glass, door handle with lock	3978	56	2225	11,782	11,832
	ARU584	Silent Room XL / Step 5 option L/H glass facade with doors in metal frame with MFC front cover, 8mm tempered safety glass, door handle with lock	3978	56	2225	11,782	11,832

STEP 6	CODE	DESCRIPTION	WIDTH	DEPTH	HEIGHT	RSP (£)
	AR8602	Silent Room XL / Step 6 MFC ceiling with LED light and ventilation (air extraction) system	3932	2380	78	13,789
	ARU701	Autonomous smoke alarm <i>Optional</i>	110	110	39	344
	ARU702	Smoke alarm for fire alarm system <i>Optional</i>	104	104	35	135

G1: Band A MFC G2: Band B MFC

STEP 7	CODE	DESCRIPTION	WIDTH	DEPTH	HEIGHT	G1 (£)	G2 (£)
	AR8702	MFC floor covered with carpet, metal frame structure	3975	2423	78	6,824	6,849

Preconfigured pod ideas

G1: Band A Fabric + Band A MFC Media Wall		G2: Band B Fabric + Band A MFC Media Wall		G3: Band C Fabric + Band A MFC Media Wall				
CODE	DESCRIPTION	WIDTH	DEPTH	HEIGHT	G1 (£)	G2 (£)	G3 (£)	
 ARK801	Silent Room XL with upholstered external and internal walls, internal front central wall with control system, glass doors, MFC ceiling and MFC floors covered with carpet	3978	2425	2306	59,839	65,754	70,571	
G1: Band A MFC + Band A Fabric Internal Walls		G2: Band B MFC + Band B Fabric Internal Walls						
CODE	DESCRIPTION	WIDTH	DEPTH	HEIGHT	G1 (£)	G2 (£)		
 ARK802	Silent Room XL with MFC external and upholstered internal walls, internal front central wall with control system, glass doors, MFC ceiling and MFC floors covered with carpet	3978	2422	2306	57,674	60,833		
 ARK804	Silent Room XL with MFC external walls and rear panel with glass, upholstered internal walls, internal front central wall with control system, glass doors, MFC ceiling and MFC floors covered with carpet	3978	2422	2306	59,722	61,360		
 ARK805	Silent Room XL with MFC external and upholstered internal walls, internal front central wall with control system, glass doors, MFC ceiling and MFC floors covered with carpet, equipped with soft seating and 3 x laptop tables (SHD041)	3978	2422	2306	65,822	68,982		
 ARK806	Silent Room XL with MFC external walls and rear panel with glass, upholstered internal walls, internal front central wall with control system, glass doors, MFC ceiling and MFC floors covered with carpet, equipped with table (DNA180-U) and 6 x Twist & Sit sled base conference chairs (SDA120)	3978	2422	2306	62,348	63,988		

G1: Band A Fabric + Band A MFC G2: Band A Fabric + Band B MFC		G3: Band B Fabric + Band A MFC G4: Band B Fabric + Band B MFC		G5: Band C Fabric + Band A MFC G6: Band C Fabric + Band B MFC						
CODE	DESCRIPTION	WIDTH	DEPTH	HEIGHT	G1 (£)	G2 (£)	G3 (£)	G4 (£)	G5 (£)	G6 (£)
 ARK803	Silent Room XL with upholstered external walls and rear panel with glass, upholstered internal walls, internal front central wall with control system, glass doors, MFC ceiling and MFC floors covered with carpet	3978	2422	2306	60,926	61,005	63,994	64,073	66,571	66,650



Jazz Box

Acoustic meeting booths

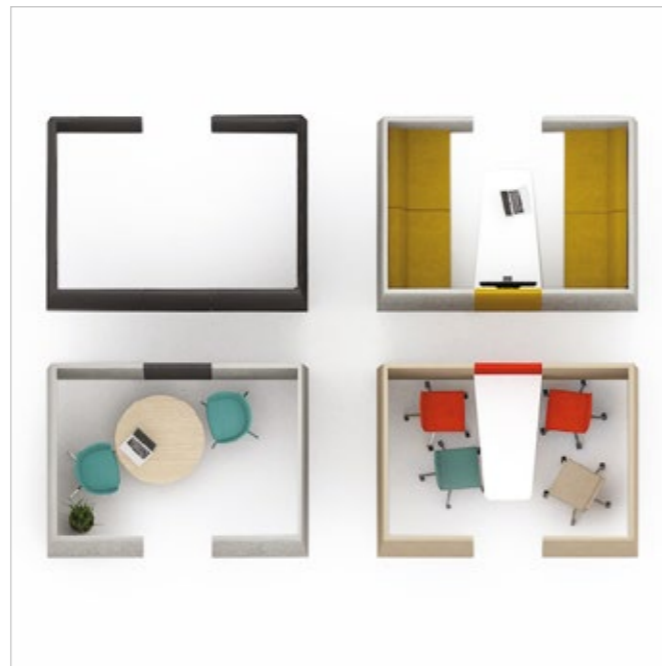

For a peaceful zone at your noisy office environment, Jazz Box is perfect for individual work, short meetings or for taking breaks during the day.

Combine soft seating, table, monitor holder and other accessories to create a space adjusted to individual needs.

Range

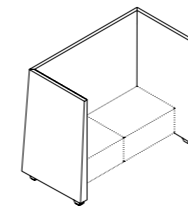

1810 x 925 x 1420

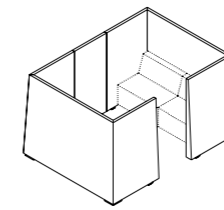

2500 x 1810 x 1420

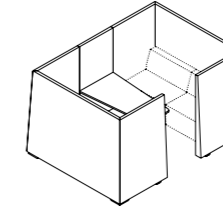

2500 x 1810 x 1420

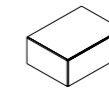

800 x 600 x 400

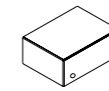

800 x 600 x 400

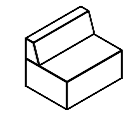

800 x 600 x 650

Technical details

ACOUSTIC WALLS

Walls frame

- Made of 18mm medium density fibreboard and 18mm chipboard
- Coated with specially shaped foam VB2540 (density: 25kg/m³) from outside and acoustic foam from the inside
- Top and sides softened with VB2240 3mm foam

Legs

- MDF painted in black, H39mm

POUFS

Pouf frame

- 15mm plywood and 15mm chipboard

Seat

- Upper part is foam coated HR5050 (density: 48-51 kg/m³), lower layer of the foam HR3030 (density: 28-32 kg/m³); frame sides are foam coated HR3030 (density: 28-32 kg/m³)

Base

- Black painted rectangular metal base (50 x 20 x 1.5 mm) with 4 plastic glides (5mm)
- Ability to order linking parts (2 pcs.), which allow linkage of the poufs to lines

Cushion

- Made of foam (HR3538), upholstered with fabric;
- Zipper sewn into the lower part.

Power socket

- 1 socket for 230V with 1.5m cable
- UK, EU, FR, CH sockets available

DESK & LINKING CENTRAL WALL

Desktop

- 1200 x 650 x 663 mm, made of 25mm LMDP
- Power socket with 4 wire management holes is mounted into the desktop (only for AGS183)
- Metal box for cable management is fixed under the desktop: 185 x 150 mm, H100mm if there is a power socket

Table

- Made of metal tube: 70 x 20 x 2 mm
- Black painted leg glides are made of MDF, H16mm

Wall frame

- Made of MDF (18mm) and MFC (melamine, 18mm)
- Fittings are placed on the side to attach other walls

Foam

- Frame is coated with specially shaped foam from outside and acoustic foam from the inside

Wall legs

- Black painted MDF legs, H39mm

Monitor holder

- Three height adjustable positions
- VESA standards: 75 x 75, 100 x 100 mm
- Recommended weight up to 10kg

Wire management

- Space with zips for wire management

Materials

Fabric*

Velito
Camira Synergy

Metal



Black (A)
White (E)





Band A MFC







Whitened Oak (D1)
Amber Oak (D2)
White (M1)
Pearl Grey (N3)

Band B MFC

Sand Ash (D3)
Dark Walnut (D4)
Grey Wood (D5)
Cubanit Grey (N2)

	CODE	DESCRIPTION				G1: Band A MFC		G2: Band B MFC	
			WIDTH	DEPTH	HEIGHT	G1 (£)	G2 (£)		
	AGS182	Booth with table (W1200 x D650 x H663) and black MDF feet	1810	2500	1420	7,542	7,572		
	AGS183	Booth with table (W1200 x D650 x H663), monitor holder, power socket, wires box and black MDF feet	1810	2500	1420	7,833	7,867		
	AGS184	Booth with table (W1200 x D650 x H663), monitor holder, power socket with USB fast charge, wires box and black MDF feet	1810	2500	1420	8,423	8,452		

	CODE	DESCRIPTION	WIDTH	DEPTH	HEIGHT	RSP (£)
	AGS180	Open booth with black MDF feet	1810	925	1420	3,317
	AGS181	Booth with black MDF feet	1810	2500	1420	7,335
	SGA1L0	L/H pouf with linking parts, black painted metal base	800	600	400	972
	SGA1R0	R/H pouf with linking parts, black painted metal base	800	600	400	972

	CODE	DESCRIPTION	WIDTH	DEPTH	HEIGHT	RSP (£)
	SGA109	L/H pouf with power socket and linking parts, black painted metal base	800	600	400	1,138
	SGA110	R/H pouf with power socket and linking parts, black painted metal base	800	600	400	1,138
	SGA113	L/H pouf with USB fast charge socket and linking parts, black painted metal base	800	600	400	1,339
	SGA114	R/H pouf with USB fast charge socket and linking parts, black painted metal base	800	600	400	1,339
	ZGZ005	Back cushion for pouf	800	200	300	291
	SGZ001	Metal table for pouf	602	400	122	216
	ZGZ003	Metal 'Do not disturb' accessory	118	44	121	78

Arcipelago Wood

Meeting booths

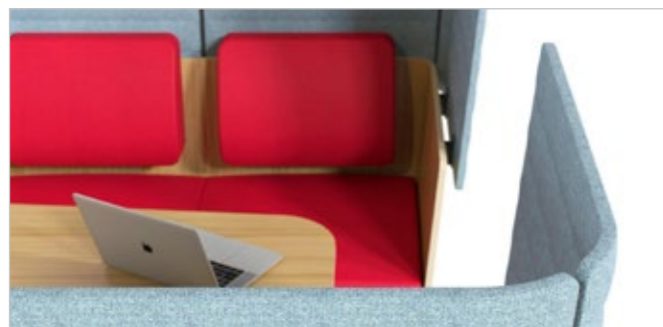

Compatible
with Solo Smart
Charge power
module

Arcipelago Wood gives your employees a calm, focused 'room within a room' where they can conduct meetings, collaborate and reduce ambient noise to enhance focus.

A harmonious combination of oak veneered plywood and upholstered panels, Arcipelago Wood meeting booths transform workspaces with their use of natural elements and colours to create a positive effect on productivity and mood of employees.

Technical details

Wooden base

- Straight and curved segments made from 18mm birch plywood, covered with modified, lacquered oak veneer, R1mm rounded edges
- Segments joined with plastic connectors, using hex/allen key
- Straight panels have 2 height adjustable plastic legs (+15mm)

High back segments

- Internal metal frame molded with PU foam (100kg/m³)
- Zippers on the sides to connect each segment
- Connects to wooden base with plastic brackets

Seat base

- Base under the seats (1280 x 600 x 80 mm) is made from black 18mm MFC, with 1mm ABS edging
- Beam under the seat base is made from powder coated metal tube 40 x 40 mm
- Upholstered part is made from powder coated metal tube 70 x 20 mm, softened with foam
- Seat base fixed to wooden base
- Ø45mm velcro pads fix seat base to cushions
- Recommended load up to 110kg per seat

Seat cushions

- 1 seater square seat cushion (650 x 650 x 130 mm) is made from PU foam (65-70kg/m³), upholstered with fabric
- Ø45mm velcro pads fix cushions to seat base
- Seating depth – 530mm

Back cushions

- Base (515 x 375 mm) made from black 18mm MFC with 2mm ABS edging
- Filled with foam, upholstered with fabric
- Back cushions fixed to wooden base

Table

- 1100 x 800 mm tabletop made

- from 18mm birch plywood covered with modified, lacquered oak veneer with R1mm rounded edges
- Fixed to wooden base with 2 metal brackets
- H720mm from floor
- Lacquered and stained natural ash solid wood leg (694x54x59 mm) with metal plate 120 x 120 x 4 mm to fix to tabletop
- Plastic height levelling feet (+15mm)

Monitor holder

- Monitor holder base made from powder coated metal tube 70 x 20 x H390 mm
- VESA plate (120 x 120 mm) made from 2mm metal sheet
- 75 x 75 mm & 100 x 100 mm mount spacings and recommended weight up to 10kg -
- Can be mounted at 3 different heights
- Bolts not included

Wiring

- Upper wiring cover (100 x 340 mm) made from 18mm birch plywood, covered with modified, lacquered oak veneer and fixed to monitor holder
- Lower wiring cover (592 x 340 mm) made from 18mm birch plywood, covered with modified, lacquered oak veneer and fixed with 2 powder coated metal tubes 20 x 20 mm
- R1mm rounded edges
- 20mm gap between wooden base and lower wiring cover
- Box for wires (340 x 169 x 95 mm) made from 1mm powder coated metal, placed under the tabletop with option to mount power socket block inside

Materials

G1 Fabric*

Berta

G2 Fabric*

Step/Step Melange

G3 Fabric*

Cyber 

Camira Synergy

Booth base & Tabletop

Oak veneer (A1)



Legs

Ash stained Light Grey (W2)

Metal

Black (A)

 Eco friendly

	CODE	DESCRIPTION	WIDTH	DEPTH	HEIGHT	SEAT	G1 (£)	G2 (£)	G3 (£)
	SHA407	4 seater meeting booth	2276	1480	1636	450	9,763	10,263	10,704
	SHA406	4 seater meeting booth with table	2596	1480	1636	450	10,807	11,317	11,730
	SHA405	4 seater meeting booth with table, monitor holder and cut-out for 80mm power module (order separately)	2596	1480	1636	450	11,456	11,969	12,386

Seating

Task chairs

Meeting chairs

Conference chairs

Canteen chairs

Stools

Lounge chairs

Soft seating



Twist & Sit seating range

Modena

Task + Executive chairs

Huge choice
of fabrics
available!



Our Modena mesh back task chair with its distinctive Y-shape backrest commands attention and is perfectly suited for any modern office environment.

You can fully customise Modena to create a comfortable experience tailored to any user with a choice of mesh or solid fabric backrest, fixed or sliding seat as well as adjustable headrest, choice of armrests and adjustable lumbar support.

The choice of frame colour, base finish and a host of fabric options allow you to finish this chair to match your personal style.

Can't see the configuration you're after? Please ask and we may be able to create it for you.

Range

Task chair

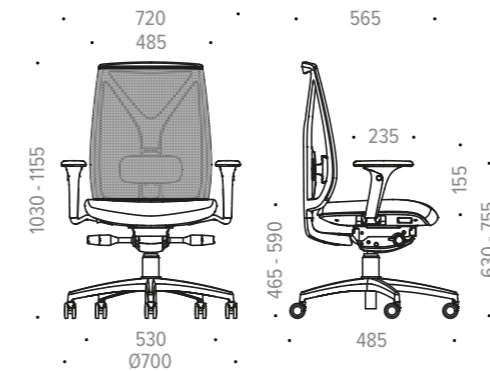

Executive chair

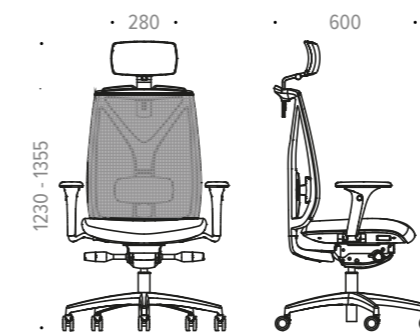

Fabric back task chair

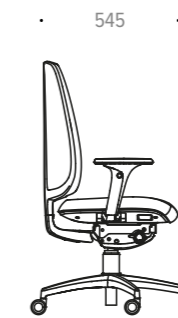

Fabric back executive chair







Materials

G1 Fabric

Camira Era
Camira Target
Fidivi Bondai
Gabriel Chili 
Gabriel Event
Gabriel Just 
Gabriel Tonal 



G2 Fabric

Camira Quest 
Camira Vita
Camira X2
Camira Xtreme 
Chieftain Just Colour
Gabriel Go Check
Gabriel Go Uni
Gabriel Runner 
Gabriel Step
Gabriel Step Melange
Gabriel Cyber 

G3 Fabric

Camira Aspect
Camira Chateau
Camira Oceanic 
Gabriel Crisp
Gabriel Fighter
Gabriel Medley

G4 Fabric

Camira Blazer 
Camira Regent
Camira Sumi
Camira Synergy
Gabriel Go Couture
Gabriel Rondo 

Frame

Black
White

Mesh

Black

Base

Black nylon
White nylon
Polished aluminium

 Eco friendly

Technical

Seat

- Foam made of polyurethane

Back

- Black or white plastic frame
- Upholstered with black mesh or choice of fabric
- Height adjustable

Lumbar support

- Depth adjustable
- White or black plastic to match frame

Headrest

- Height adjustable
- Upholstered, black or white plastic to match frame

Armrests

- Height adjustable, black or white plastic with black soft pads
- 4D adjustable, black or white plastic with black soft pads

Mechanism

- Synchronized mechanism, tension adjustment with quick side tension regulation by lever

Bases

- 5-star polished aluminium with chrome gas lift
- 5-star black or white nylon with black gas lift

Castors

- Ø60mm rubber freewheel castors for hard floor
- Ø60mm PA freewheel castors for soft floor
- White ring detail in castors with white frame

	CODE	DESCRIPTION	WIDTH	DEPTH	HEIGHT	SEAT	G1 (£)	G2 (£)	G3 (£)	G4 (£)
	TMMFSN-1S/BB	Black mesh back, fixed seat, black 5-star base, black height adj. armrests (pair) with soft black pads, soft floor castors	Ø700	565	1030 - 1155	465 - 590	604	610	625	637
	TMMFHN-1S/BB	Hard floor castors	Ø700	565	1030 - 1155	465 - 590	615	621	636	648
	TMLSSN-4S/BB	Black mesh back with lumbar support, sliding seat, black 5-star base, black 4D adj. armrests (pair) with soft black pads, soft floor castors	Ø700	565	1030 - 1155	465 - 590	710	716	731	743
	TMLSHN-4S/BB	Hard floor castors	Ø700	565	1030 - 1155	465 - 590	721	727	742	754
	TMLSSN-4S/BA	Black mesh back with lumbar support, sliding seat, aluminium 5-star base, black 4D adj. armrests (pair) with soft black pads, soft floor castors	Ø700	565	1030 - 1155	465 - 590	770	776	791	803
	TMLSHN-4S/BA	Hard floor castors	Ø700	565	1030 - 1155	465 - 590	781	787	802	814
	TMFFSN-1S/BB	Black fabric back, fixed seat, black 5-star base, black height adj. armrests (pair) with soft black pads, soft floor castors	Ø700	545	1030 - 1155	465 - 590	594	608	642	671
	TMFFHN-1S/BB	Hard floor castors	Ø700	545	1030 - 1155	465 - 590	605	619	653	682
	TMFSSN-4S/BA	Black fabric back, sliding seat, aluminium 5-star base, black 4D adj. armrests (pair) with soft black pads, soft floor castors	Ø700	545	1030 - 1155	465 - 590	712	726	760	789
	TMFSHN-4S/BA	Hard floor castors	Ø700	545	1030 - 1155	465 - 590	723	737	771	800

Don't need black height adjustable armrests?

To order Modena without black armrests reduce RSP by £73 and replace '1S' in order code with 'NA'.

TMNFSN-1S/BB *Height adjustable armrests*
 TMNFSN-NA/BB *No armrests*

	CODE	DESCRIPTION	WIDTH	DEPTH	HEIGHT	SEAT	G1 (£)	G2 (£)	G3 (£)	G4 (£)
	TMMFSH-1S/BB	Black mesh back, fixed seat, black 5-star base, black height adj. armrests (pair) with soft black pads, headrest with coat hanger, soft floor castors	Ø700	600	1230 - 1355	465 - 590	709	716	735	750
	TMMFHH-1S/BB	Hard floor castors	Ø700	600	1230 - 1355	465 - 590	720	727	746	761
	TMLSSH-4S/BB	Black mesh back with lumbar support, sliding seat, black 5-star base, black 4D adj. armrests (pair) with soft black pads, headrest with coat hanger, soft floor castors	Ø700	600	1230 - 1355	465 - 590	815	822	841	856
	TMLSHH-4S/BB	Hard floor castors	Ø700	600	1230 - 1355	465 - 590	826	833	852	867
	TMLSSH-4S/BA	Black mesh back with lumbar support, sliding seat, aluminium 5-star base, black 4D adj. armrests (pair) with soft black pads, headrest with coat hanger, soft floor castors	Ø700	600	1230 - 1355	465 - 590	875	882	901	916
	TMLSHH-4S/BA	Hard floor castors	Ø700	600	1230 - 1355	465 - 590	886	893	912	927
	TMFFSH-1S/BB	Black fabric back, fixed seat, black 5-star base, black height adj. armrests (pair) with soft black pads, headrest with coat hanger, soft floor castors	Ø700	615	1230 - 1355	465 - 590	699	714	752	784
	TMFFHH-1S/BB	Hard floor castors	Ø700	615	1230 - 1355	465 - 590	710	725	763	795
	TMFSSH-4S/BA	Black fabric back, sliding seat, aluminium 5-star base, black 4D adj. armrests (pair) with soft black pads, headrest with coat hanger, soft floor castors	Ø700	615	1230 - 1355	465 - 590	817	832	870	902
	TMFSHH-4S/BA	Hard floor castors	Ø700	615	1230 - 1355	465 - 590	828	843	881	913





Don't need black 4D adjustable armrests?

To order Modena without black 4D armrests reduce RSP by £97 and replace '4S' in order code with 'NA'.

TMLSSN-4S/BB *4D adjustable armrests*
 TMLSSN-NA/BB *No armrests*

	CODE	DESCRIPTION	WIDTH	DEPTH	HEIGHT	SEAT	G1 (£)	G2 (£)	G3 (£)	G4 (£)
	TMMFSN-1S/WW	White mesh back, fixed seat, white 5-star base, white height adj. armrests (pair) with soft black pads, soft floor castors	Ø700	565	1030 - 1155	465 - 590	599	605	620	632
	TMMFHN-1S/WW	Hard floor castors	Ø700	565	1030 - 1155	465 - 590	610	616	631	643
	TMMFSN-1S/WB	White mesh back, fixed seat, black 5-star base, white height adj. armrests (pair) with soft black pads, soft floor castors	Ø700	565	1030 - 1155	465 - 590	599	605	620	632
	TMMFHN-1S/WB	Hard floor castors	Ø700	565	1030 - 1155	465 - 590	610	616	631	643
	TMMSSN-4S/WB	White mesh back, sliding seat, black 5-star base, white 4D adj. armrests (pair) with soft black pads, soft floor castors	Ø700	565	1030 - 1155	465 - 590	657	663	678	690
	TMMSHN-4S/WB	Hard floor castors	Ø700	565	1030 - 1155	465 - 590	668	674	689	701
	TMLFSN-1S/WB	White mesh back with lumbar support, fixed seat, black 5-star base, white height adj. armrests (pair) with soft black pads, soft floor castors	Ø700	565	1030 - 1155	465 - 590	647	653	668	680
	TMLFHN-1S/WB	Hard floor castors	Ø700	565	1030 - 1155	465 - 590	658	664	679	691
	TMLSSN-4S/WW	White mesh back with lumbar support, sliding seat, white 5-star base, white 4D adj. armrests (pair) with soft black pads, soft floor castors	Ø700	565	1030 - 1155	465 - 590	705	711	726	738
	TMLSHN-4S/WW	Hard floor castors	Ø700	565	1030 - 1155	465 - 590	716	722	737	749
	TMLSSN-4S/WB	White mesh back with lumbar support, sliding seat, black 5-star base, white 4D adj. armrests (pair) with soft black pads, soft floor castors	Ø700	565	1030 - 1155	465 - 590	705	711	726	738
	TMLSHN-4S/WB	Hard floor castors	Ø700	565	1030 - 1155	465 - 590	716	722	737	749

	CODE	DESCRIPTION	WIDTH	DEPTH	HEIGHT	SEAT	G1 (£)	G2 (£)	G3 (£)	G4 (£)
	TMLSSN-4S/WA	White mesh back with lumbar support, sliding seat, aluminium 5-star base, white 4D adj. armrests (pair) with soft black pads, soft floor castors	Ø700	565	1030 - 1155	465 - 590	705	711	726	738
	TMLSHN-4S/WA	Hard floor castors	Ø700	565	1030 - 1155	465 - 590	716	722	737	749
	TMMFSH-1S/WW	White mesh back, fixed seat, white 5-star base, white height adj. armrests (pair) with soft black pads, headrest with coat hanger, soft floor castors	Ø700	600	1230 - 1355	465 - 590	704	711	730	745
	TMMFHH-1S/WW	Hard floor castors	Ø700	600	1230 - 1355	465 - 590	715	722	741	756
	TMMFSH-1S/WB	White mesh back, fixed seat, black 5-star base, white height adj. armrests (pair) with soft black pads, headrest with coat hanger, soft floor castors	Ø700	600	1230 - 1355	465 - 590	704	711	730	745
	TMMFHH-1S/WB	Hard floor castors	Ø700	600	1230 - 1355	465 - 590	715	722	741	756
	TMMSSH-4S/WB	White mesh back, sliding seat, black 5-star base, white 4D adj. armrests (pair) with soft black pads, headrest with coat hanger, soft floor castors	Ø700	600	1230 - 1355	465 - 590	762	769	788	803
	TMMSHH-4S/WB	Hard floor castors	Ø700	600	1230 - 1355	465 - 590	773	780	799	814
	TMLFSH-1S/WB	White mesh back with lumbar support, fixed seat, black 5-star base, white height adj. armrests (pair) with soft black pads, headrest with coat hanger, soft floor castors	Ø700	600	1230 - 1355	465 - 590	752	759	778	793
	TMLFHH-1S/WB	Hard floor castors	Ø700	600	1230 - 1355	465 - 590	763	770	789	804
	TMLSSH-4S/WW	White mesh back with lumbar support, sliding seat, white 5-star base, white 4D adj. armrests (pair) with soft black pads, headrest with coat hanger, soft floor castors	Ø700	600	1230 - 1355	465 - 590	810	817	836	851
	TMLSHH-4S/WW	Hard floor castors	Ø700	600	1230 - 1355	465 - 590	821	828	847	862

	CODE	DESCRIPTION	WIDTH	DEPTH	HEIGHT	SEAT	G1 (£)	G2 (£)	G3 (£)	G4 (£)
	TMLSSH-4S/WB	White mesh back with lumbar support, sliding seat, black 5-star base, white 4D adj. armrests (pair) with soft black pads, headrest with coat hanger, soft floor castors	Ø700	600	1230 - 1355	465 - 590	810	817	836	851
	TMLSHH-4S/WB	Hard floor castors	Ø700	600	1230 - 1355	465 - 590	821	828	847	862
	TMLSSH-4S/WA	White mesh back with lumbar support, sliding seat, aluminium 5-star base, white 4D adj. armrests (pair) with soft black pads, headrest with coat hanger, soft floor castors	Ø700	600	1230 - 1355	465 - 590	810	817	836	851
	TMLSHH-4S/WA	Hard floor castors	Ø700	600	1230 - 1355	465 - 590	821	828	847	862
	TMFFSN-1S/WW	White fabric back, fixed seat, white 5-star base, white height adj. armrests (pair) with soft black pads, soft floor castors	Ø700	545	1030 - 1155	465 - 590	589	603	637	666
	TMFFHN-1S/WW	Hard floor castors	Ø700	545	1030 - 1155	465 - 590	600	614	648	677
	TMFSSN-4S/WA	White fabric back, sliding seat, aluminium 5-star base, white 4D adj. armrests (pair) with soft black pads, soft floor castors	Ø700	545	1030 - 1155	465 - 590	647	661	695	724
	TMFSHN-4S/WA	Hard floor castors	Ø700	545	1030 - 1155	465 - 590	658	672	706	735
	TMFFSN-1S/WB	White fabric back, fixed seat, black 5-star base, white height adj. armrests (pair) with soft black pads, soft floor castors	Ø700	545	1030 - 1155	465 - 590	589	603	637	666
	TMFFHN-1S/WB	Hard floor castors	Ø700	545	1030 - 1155	465 - 590	600	614	648	677

Don't need white height adjustable armrests?

To order Modena without white armrests reduce RSP by £73 and replace '1S' in order code with 'NA'.

TMFFSN-1S/WW *Height adjustable armrests*
 TMFFSN-NA/WW *No armrests*

	CODE	DESCRIPTION	WIDTH	DEPTH	HEIGHT	SEAT	G1 (£)	G2 (£)	G3 (£)	G4 (£)
	TMFSSN-4S/WW	White fabric back, sliding seat, white 5-star base, white 4D adj. armrests (pair) with soft black pads, soft floor castors	Ø700	545	1030 - 1155	465 - 590	647	661	695	724
	TMFSHN-4S/WW	Hard floor castors	Ø700	545	1030 - 1155	465 - 590	658	672	706	735
	TMFFSH-1S/WW	White fabric back, fixed seat, white 5-star base, white height adj. armrests (pair) with soft black pads, headrest with coat hanger, soft floor castors	Ø700	615	1230 - 1355	465 - 590	694	709	747	779
	TMFFHH-1S/WW	Hard floor castors	Ø700	615	1230 - 1355	465 - 590	705	720	758	790
	TMFSSH-4S/WA	White fabric back, sliding seat, aluminium 5-star base, white 4D adj. armrests (pair) with soft black pads, headrest with coat hanger, soft floor castors	Ø700	615	1230 - 1355	465 - 590	752	767	805	837
	TMFSHH-4S/WA	Hard floor castors	Ø700	615	1230 - 1355	465 - 590	763	778	816	848
	TMFFSH-1S/WB	White fabric back, fixed seat, black 5-star base, white height adj. armrests (pair) with soft black pads, headrest with coat hanger, soft floor castors	Ø700	615	1230 - 1355	465 - 590	694	709	747	779
	TMFFHH-1S/WB	Hard floor castors	Ø700	615	1230 - 1355	465 - 590	705	720	758	790
	TMFSSH-4S/WW	White fabric back, sliding seat, white 5-star base, white 4D adj. armrests (pair) with soft black pads, headrest with coat hanger, soft floor castors	Ø700	615	1230 - 1355	465 - 590	752	767	805	837
	TMFSHH-4S/WW	Hard floor castors	Ø700	615	1230 - 1355	465 - 590	763	778	816	848

Don't need white 4D adjustable armrests?

To order Modena without white 4D armrests reduce RSP by £108 and replace '4S' in order code with 'NA'.

TMLSSH-4S/WB *4D adjustable armrests*
 TMLSSH-NA/WB *No armrests*

Verona

Mesh back task chair

Huge choice
of fabrics
available!



Our comfortable Verona task chair with rounded backrest adds a soft aesthetic to any workspace.

The sliding seat option and a choice of armrests offer additional adaptability. Frames are available in white or black with a large choice of seat fabric options.

Can't see the configuration you're after? Please ask and we may be able to create it for you.

Range

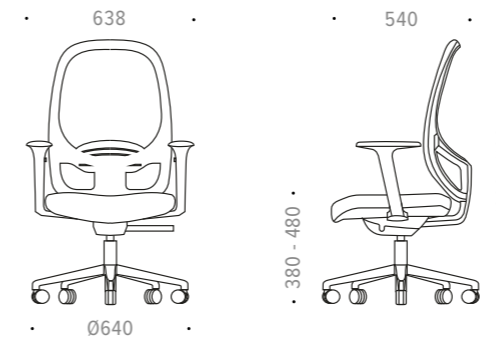

Technical

Seat

- Foam made of polyurethane

Back

- Black or white plastic frame with black mesh

Lumbar support

- Height adjustable
- White or black plastic to match frame

Armrests

- Height adjustable, black or white plastic with black soft pads

Mechanism

- Synchronized mechanism, 3 locking positions

Bases

- 5-star polished aluminium with chrome gas lift
- 5-star black nylon with black gas lift

Castors



- 50mm rubber freewheel castors for hard floor
- 50mm PA freewheel castors for soft floor

Materials

G1 Fabric

Camira Era
Camira Target
Fidivi Bondai
Gabriel Chili 
Gabriel Event
Gabriel Just 
Gabriel Tonal 



G2 Fabric

Camira Quest 
Camira Vita
Camira X2
Camira Xtreme 
Chieftain Just Colour
Gabriel Go Check
Gabriel Go Uni
Gabriel Runner 
Gabriel Step
Gabriel Step Melange
Gabriel Cyber 

G3 Fabric

Camira Aspect
Camira Chateau
Camira Oceanic 
Gabriel Crisp
Gabriel Fighter
Gabriel Medley

G4 Fabric

Camira Blazer 
Camira Regent
Camira Sumi
Camira Synergy
Gabriel Go Couture
Gabriel Rondo 

Frame

Black
White





Mesh

Black

Base

Black nylon
Polished aluminium





 Eco friendly

	CODE	DESCRIPTION	WIDTH	DEPTH	HEIGHT	SEAT	G1 (£)	G2 (£)	G3 (£)	G4 (£)
	TCRLFS-1S/BB	Black mesh back with lumbar support, fixed seat, black 5-star base, height adjustable armrests (pair) with soft black pads, soft floor castors	Ø640	540	1000-1100	450-580	434	440	455	467
	TCRLFH-1S/BB	Hard floor castors	Ø640	540	1000-1100	450-580	440	446	461	473
	TCRLSS-1S/BB	Black mesh back with lumbar support, sliding seat, black 5-star base, height adjustable armrests (pair) with soft black pads, soft floor castors	Ø640	540	1000-1100	450-580	457	463	478	490
	TCRLSH-1S/BB	Hard floor castors	Ø640	540	1000-1100	450-580	463	469	484	496
	TCRLFS-1S/BA	Black mesh back with lumbar support, fixed seat, aluminium 5-star base, height adjustable armrests (pair) with soft black pads, soft floor castors	Ø640	540	1000-1100	450-580	466	472	487	499
	TCRLFH-1S/BA	Hard floor castors	Ø640	540	1000-1100	450-580	472	478	493	505
	TCRLSS-1S/BA	Black mesh back with lumbar support, sliding seat, aluminium 5-star base, height adjustable armrests (pair) with soft black pads, soft floor castors	Ø640	540	1000-1100	450-580	489	495	510	522
	TCRLSH-1S/BA	Hard floor castors	Ø640	540	1000-1100	450-580	495	501	516	528

Don't need black armrests?

To order Verona without black armrests reduce RSP by £73 and replace '1S' in order code with 'NA'.

TCRLFS-1S/BB *Height adjustable armrests*
 TCRLFS-NA/BB *No armrests*

	CODE	DESCRIPTION	WIDTH	DEPTH	HEIGHT	SEAT	G1 (£)	G2 (£)	G3 (£)	G4 (£)
	TCRLFS-1S/WB	White mesh back with lumbar support, fixed seat, black 5-star base, height adjustable armrests (pair) with soft black pads, soft floor castors	Ø640	540	1000-1100	450-580	458	464	478	491
	TCRLFH-1S/WB	Hard floor castors	Ø640	540	1000-1100	450-580	464	470	484	497
	TCRLSS-1S/WB	White mesh back with lumbar support, sliding seat, black 5-star base, height adjustable armrests (pair) with soft black pads, soft floor castors	Ø640	540	1000-1100	450-580	481	487	501	514
	TCRLSH-1S/WB	Hard floor castors	Ø640	540	1000-1100	450-580	487	493	507	520
	TCRLFS-1S/WA	White mesh back with lumbar support, fixed seat, aluminium 5-star base, height adjustable armrests (pair) with soft black pads, soft floor castors	Ø640	540	1000-1100	450-580	490	496	510	523
	TCRLFH-1S/WA	Hard floor castors	Ø640	540	1000-1100	450-580	496	502	516	529
	TCRLSS-1S/WA	White mesh back with lumbar support, sliding seat, aluminium 5-star base, height adjustable armrests (pair) with soft black pads, soft floor castors	Ø640	540	1000-1100	450-580	513	519	533	546
	TCRLSH-1S/WA	Hard floor castors	Ø640	540	1000-1100	450-580	519	525	539	552

Don't need white armrests?

To order Verona without white armrests reduce RSP by £73 and replace '1S' in order code with 'NA'.

TCRLFS-1S/WB *Height adjustable armrests*
 TCRLFS-NA/WB *No armrests*

Veneto

Mesh back task chair + Executive task chair



If you liked Vienna, you'll love Veneto!

The Veneto task chair gives strength, comfort, style and performance at a value price. The executive chair features a synchronised mechanism, sliding black fabric seat and adjustable headrest. Both chairs offer an adjustable lumbar support and adjustable armrests.

Better still, Veneto task chairs are held in stock and available for express delivery - within 3-5 working days.

Don't need armrests?

To order Veneto without armrests reduce RSP by £42 and replace 'A' in order code with 'N'.

TV4A/BB-GO **Height adj. armrests**

TV4N/BB-GO **No armrests**

Technical

Veneto

- W650 x D670 x H980-1080 mm
- Seat: W485 x D485 x H455-550 mm
- Backrest: W480 x H610 mm
- Capacity 119kg recommended max. user weight
- Self-balance mechanism, 2 locking positions
- Black frame with black or polished aluminium base
- Adjustable lumbar support (50mm height range)
- Optional height adjustable armrests (60mm range)
- Universal castors
- Warranty: 5 years

Veneto Executive

- W685 x D670 x H1170-1340 mm
- Seat: W485 x D485 x H465-560 mm
- Backrest: W480 x H610 mm
- Capacity 119kg recommended max. user weight
- Synchro mechanism with side tension adjustment, seat slide function, 4 locking positions
- Black frame with black or polished aluminium base
- Adjustable lumbar support (50mm height range)
- Height adjustable headrest (65mm height range)
- Optional height adjustable armrests (60mm range)
- Universal castors
- Warranty: 5 years

Materials

Fabric seat

Black

Frame

Black

Mesh

Black

Base

Black nylon
Polished aluminium

	CODE	DESCRIPTION	WIDTH	DEPTH	HEIGHT	SEAT	RSP (£)
	TV4A/BB-GO	Task chair with self balance mechanism (2 locking positions), black mesh backrest with adj. lumbar support, fixed fabric seat, adj. armrests, black 5-star base with black gas lift, universal castors	650	670	980-1080	455-550	423
	TV4AS/BB-GO	Task chair with self balance mechanism (2 locking positions), black mesh backrest with adj. lumbar support, sliding fabric seat, adj. armrests, black 5-star base with black gas lift, universal castors	650	670	980-1080	455-550	484
	TV4A/BA-GO	Task chair with self balance mechanism (2 locking positions), black mesh backrest with adj. lumbar support, fixed fabric seat, adj. armrests, polished aluminium 5-star base with chrome gas lift, universal castors	650	670	980-1080	455-550	461
	TV4AS/BA-GO	Task chair with self balance mechanism (2 locking positions), black mesh backrest with adj. lumbar support, sliding fabric seat, adj. armrests, polished aluminium 5-star base with chrome gas lift, universal castors	650	670	980-1080	455-550	522
	TV5A/BB-GO	Executive task chair with synchro mechanism (4 locking positions) with side tension adjustment, black mesh backrest with adj. lumbar support, sliding fabric seat, adj. armrests, adj. headrest, black 5-star base with black gas lift, universal castors	685	670	1170-1340	465-560	514
	TV5A/BA-GO	Executive task chair with synchro mechanism (4 locking positions) with side tension adjustment, black mesh backrest with adj. lumbar support, sliding fabric seat, adj. armrests, adjustable headrest, polished aluminium 5-star base with chrome gas lift, universal castors	685	670	1170-1340	465-560	552

Oslo

Mesh back operator chair + meeting chair



Strength, comfort, style and performance at a value price.

With its mesh back and rear chrome accent, stylish integrated armrests and lockable tilting mechanism, our Oslo chair offers value, aesthetics and features rarely ever seen at a similar price.

Working in tandem with its task chair equivalent, the Oslo cantilever base meeting chair offers the same sleek black outfit with integrated armrests and an all black metal cantilever base.

Technical

Operator chair

- Stylish integrated armrests
- Rear chrome accent
- Lockable tilting mechanism
- Fabric seat
- Black mesh back
- Seat: W470 x D480 x H450-550 mm
- Backrest: W460 x H520 mm
- 102kg weight limit
- Single position lockable tilt (upright or float)
- Weight: 10kg
- Warranty: 5 years

Meeting chair

- Stylish integrated armrests
- Rear chrome accent
- Fabric seat
- Black mesh back
- Backrest: W460 x H520 mm
- 102kg weight limit
- Weight: 9kg
- Warranty: 5 years

Materials

Fabric seat

Black

Frame



Black

Mesh

Black

Base

Black nylon

	CODE	DESCRIPTION	WIDTH	DEPTH	HEIGHT	SEAT	RSP (£)
	CH020S	Operator chair with fixed fabric seat, black mesh backrest with integrated armrests and lockable tilt mechanism, black nylon base	600	600	940-1020	450-550	260
	CHC202	Cantilever base meeting chair with fabric seat and black mesh backrest with integrated armrests	600	650	970	450	240

Havana

Meeting / conference / canteen chairs + Stools

Huge choice
of fabrics
available!

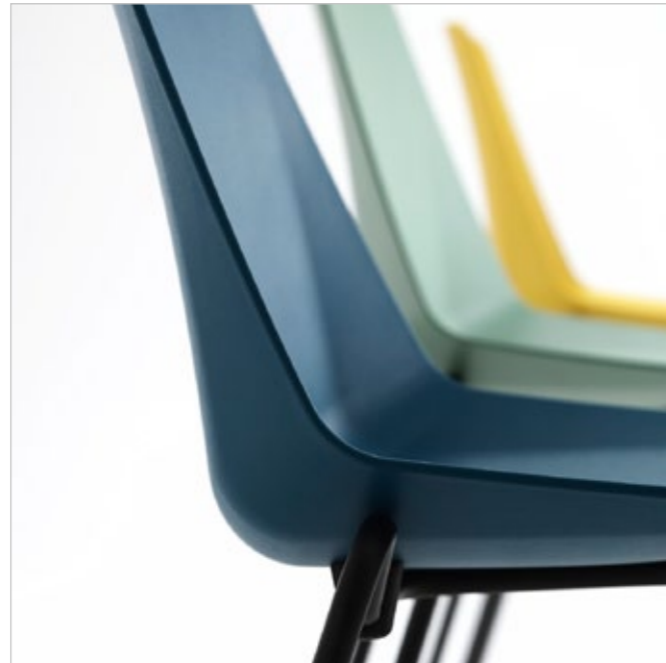

The Havana collection of lightweight chairs features a modern and essential style.

The ample and comfortable shell is available in six different colours; the frame comes in wood or metal in black, white or chrome.

Range

4 leg base

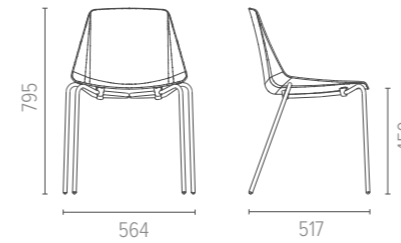

Sled base

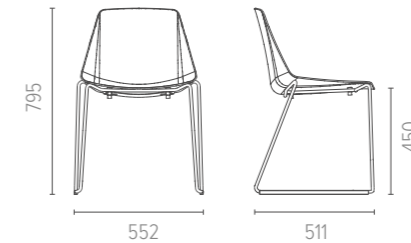

4-leg stool base

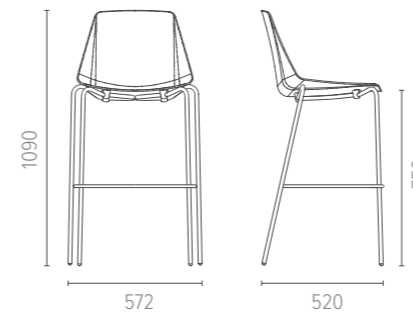

Sled stool base

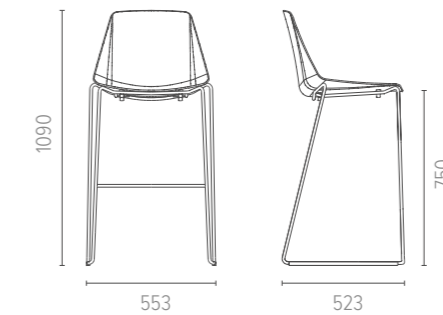

Wooden 4-leg base

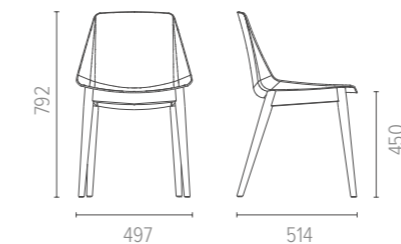

Technical

Seat

- Upholstered seat pad foam made of polyurethane

Seat / back

- Solid plastic frame available in six colours*

4 leg / 4-leg stool base

- Chrome, black or white metal
- Stackable up to 6 high

Sled / sled stool base

- Chrome, black or white metal
- Stackable up to 6 high

4-leg wooden base

- Natural beech legs

Materials

G1 Fabric

Camira Era
Camira Target
Fidivi Bondai
Gabriel Chili
Gabriel Event
Gabriel Just
Gabriel Tonal

G2 Fabric

Camira Quest
Camira Vita
Camira X2
Camira Xtreme
Chieftain Just Colour
Gabriel Go Check
Gabriel Go Uni
Gabriel Runner
Gabriel Step
Gabriel Step Melange
Gabriel Cyber

G3 Fabric

Camira Aspect
Camira Chateau
Camira Oceanic
Gabriel Crisp
Gabriel Fighter
Gabriel Medley

G4 Fabric

Camira Blazer
Camira Regent
Camira Sumi
Camira Synergy
Gabriel Go Couture
Gabriel Rondo

Plastic shell*

White
Dark Grey
Sage Green
Brick Red
Blue
Mustard Yellow





Base





White
Black
Chrome
Beech - 4 leg chair only

Eco friendly

* Plastic colours are different to Palermo and Seattle

We can supply Formetiq® Havana chairs in any fabric from the Camira and Gabriel ranges - just ask!

	CODE	DESCRIPTION	WIDTH	DEPTH	HEIGHT	SEAT	RSP (£)
	SCHPF	4-leg base	564	517	795	450	167
	SCHPS	Sled base	552	511	795	450	210
	SCHPW	4-leg natural beech wooden base	497	514	792	450	270
	SCHPC	4-leg stool base	572	520	1090	750	277
	SCHPT	Sled stool base	553	523	1090	750	283

	CODE	DESCRIPTION	WIDTH	DEPTH	HEIGHT	SEAT	G1 (£)	G2 (£)	G3 (£)	G4 (£)
	SCHFF	4-leg base, upholstered seat	564	517	795	450	240	243	255	264
	SCHFS	Sled base, upholstered seat	552	511	795	450	283	286	298	307
	SCHFW	4-leg natural beech wooden base, upholstered seat	497	514	792	450	343	346	358	367
	SCHFC	4-leg stool base, upholstered seat	572	520	1090	750	350	353	365	374
	SCHFT	Sled stool base, upholstered seat	553	523	1090	750	356	359	371	380

Madrid

Meeting + Operator chairs



Madrid offers simple modern style, comfort and reliability.

Choose from a solid supportive fabric backrest or mesh backrest offering flexibility and breathability. Stackable up to 4 chairs high, both the 4-leg or cantilever base options are available in black or chrome.

Madrid also offers a simple operator chair on a 5-star base with castors or 4-star swivel base.

formetiq

Huge choice
of fabrics
available!



formetiq

Range

4 legs

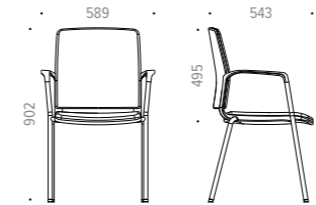

Cantilever

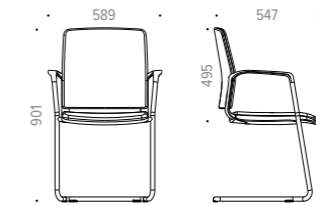

5-star castors, mesh back

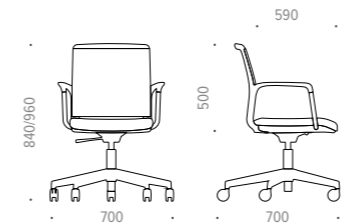

4-star swivel, mesh back

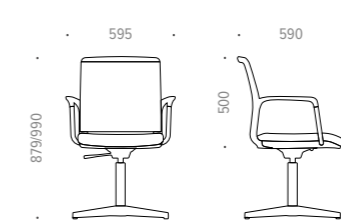

5-star castors, fabric back

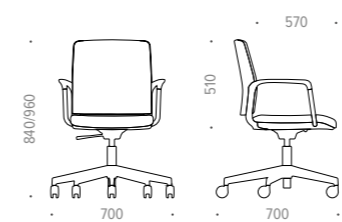

4-star swivel, fabric back

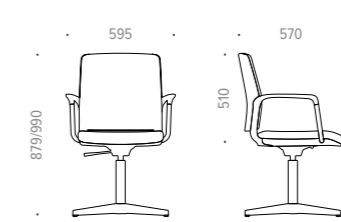

Technical

Seat

- Foam made of polyurethane

Back

- Black solid plastic frame upholstered with fabric
- White solid plastic frame upholstered with fabric
- Black plastic frame with black mesh
- White plastic frame with black mesh

4 leg base

- Chrome or black metal
- Stackable up to 4 high

Cantilever base

- Chrome or black metal
- Stackable up to 4 high

4-star swivel base

- Black, white or aluminium base with black or chrome gas lift

5-star swivel base with castors



- Black, white or aluminium base with black or chrome gas lift
- Hard floor or soft floor castors

Materials

G1 Fabric

Camira Era
Camira Target
Fidivi Bondai
Gabriel Chili 
Gabriel Event
Gabriel Just 
Gabriel Tonal 



G2 Fabric

Camira Quest 
Camira Vita
Camira X2
Camira Xtreme 
Chieftain Just Colour
Gabriel Go Check
Gabriel Go Uni
Gabriel Runner 
Gabriel Step
Gabriel Step Melange
Gabriel Cyber 

G3 Fabric

Camira Aspect
Camira Chateau
Camira Oceanic 
Gabriel Crisp
Gabriel Fighter
Gabriel Medley

G4 Fabric

Camira Blazer 
Camira Regent
Camira Sumi
Camira Synergy
Gabriel Go Couture
Gabriel Rondo 

Frame

Black
White







Mesh







Black









Base









Black
White
Aluminium

 Eco friendly

	CODE	DESCRIPTION	WIDTH	DEPTH	HEIGHT	SEAT	G1 (£)	G2 (£)	G3 (£)	G4 (£)
	MCMMF/BB	Black frame Black mesh Black 4-leg base	589	543	902	463	398	403	414	423
	MCMMF/BC	Black frame Black mesh Chrome 4-leg base	589	543	902	463	398	403	414	423
	MCMMF/WC	White frame Black mesh Chrome 4-leg base	589	543	902	463	432	436	447	456
	MCMFF/BB	Black frame Fabric back Black 4-leg base	589	543	902	463	431	440	461	480
	MCMFF/BC	Black frame Fabric back Chrome 4-leg base	589	543	902	463	431	440	461	480
	MCMFF/WC	White frame Fabric back Chrome 4-leg base	589	543	902	463	451	460	481	499

	CODE	DESCRIPTION	WIDTH	DEPTH	HEIGHT	SEAT	G1 (£)	G2 (£)	G3 (£)	G4 (£)
	MCMMC/BB	Black frame Black mesh Black cantilever base	589	547	901	462	398	402	413	422
	MCMMC/BC	Black frame Black mesh Chrome cantilever base	589	547	901	462	393	397	408	417
	MCMMC/WC	White frame Black mesh Chrome cantilever base	589	547	901	462	426	431	441	450
	MCMFC/BB	Black frame Fabric back Black cantilever base	589	547	901	462	430	439	461	479
	MCMFC/BC	Black frame Fabric back Chrome cantilever base	589	547	901	462	426	435	456	474
	MCMFC/WC	White frame Fabric back Chrome cantilever base	589	547	901	462	445	454	475	494

	CODE	DESCRIPTION	WIDTH	DEPTH	HEIGHT	SEAT	G1 (£)	G2 (£)	G3 (£)	G4 (£)
	MCMMB/BB	Black frame Black mesh Black 4-star swivel base	595	590	879-990	480-600	542	547	557	566
	MCMMB/BC	Black frame Black mesh Aluminium 4-star swivel base with chrome gas lift	595	590	879-990	480-600	540	544	555	564
	MCMMB/WW	White frame Black mesh White 4-star swivel base with black gas lift	595	590	879-990	480-600	575	580	591	600
	MCMMB/WC	White frame Black mesh Aluminium 4-star swivel base with chrome gas lift	595	590	879-990	480-600	573	578	588	597
	MCMFB/BB	Black frame Fabric back Black 4-star swivel base	595	570	879-990	480-600	575	584	605	623
	MCMFB/BC	Black frame Fabric back Aluminium 4-star swivel base with chrome gas lift	595	570	879-990	480-600	573	582	603	621
	MCMFB/WW	White frame Fabric back White 4-star swivel base with black gas lift	595	570	879-990	480-600	595	604	625	643
	MCMFB/WC	White frame Fabric back Aluminium 4-star swivel base with chrome gas lift	595	570	879-990	480-600	592	601	622	641

	CODE	DESCRIPTION	WIDTH	DEPTH	HEIGHT	SEAT	G1 (£)	G2 (£)	G3 (£)	G4 (£)
	MCMMS/BB	Black frame Black mesh Black 5-star base with castors	700	700	840-960	450-570	451	456	466	475
	MCMMS/BC	Black frame Black mesh Aluminium 5-star base with castors, chrome gas lift	700	700	840-960	450-570	505	509	520	529
	MCMMS/WW	White frame Black mesh White 5-star base with castors, black gas lift	700	700	840-960	450-570	494	498	509	518
	MCMMS/WC	White frame Black mesh Aluminium 5-star base with castors, chrome gas lift	700	700	840-960	450-570	541	546	556	565
	MCMFS/BB	Black frame Fabric back Black 5-star base with castors	700	700	840-960	450-570	484	493	514	532
	MCMFS/BC	Black frame Fabric back Aluminium 5-star base with castors, chrome gas lift	700	700	840-960	450-570	538	547	568	586
	MCMFS/WW	White frame Fabric back White 5-star base with castors, black gas lift	700	700	840-960	450-570	513	522	543	561
	MCMFS/WC	White frame Fabric back Aluminium 5-star base with castors, chrome gas lift	700	700	840-960	450-570	560	569	590	608

Prague

Mesh back pyramid base meeting chair

Huge choice
of fabrics
available!



The elegant Prague meeting chair with sleek curved armrests and pyramid base provides a sophisticated addition to any workspace.

The optional auto return function returns the chair to a forward facing position, ensuring that your meeting room always looks tidy when visitors leave.

Range

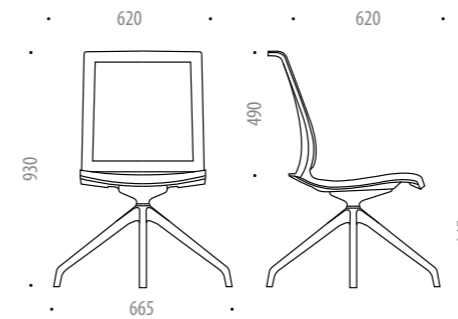

Technical

Seat

- Foam made of polyurethane

Back

- Black plastic frame with black mesh

Legs



- 4 leg pyramid base in black nylon
- 4 leg pyramid base with auto return function in black nylon

Materials

G1 Fabric

Camira Era
Camira Target
Fidivi Bondai
Gabriel Chili 
Gabriel Event
Gabriel Just 
Gabriel Tonal 



G2 Fabric

Camira Quest 
Camira Vita
Camira X2
Camira Xtreme 
Chieftain Just Colour
Gabriel Go Check
Gabriel Go Uni
Gabriel Runner 
Gabriel Step
Gabriel Step Melange
Gabriel Cyber 

G3 Fabric

Camira Aspect
Camira Chateau
Camira Oceanic 
Gabriel Crisp
Gabriel Fighter
Gabriel Medley

G4 Fabric

Camira Blazer 
Camira Regent
Camira Sumi
Camira Synergy
Gabriel Go Couture
Gabriel Rondo 

Frame

Black



Mesh

Black

Base

Black nylon

 Eco friendly

	CODE	DESCRIPTION	WIDTH	DEPTH	HEIGHT	SEAT	G1 (£)	G2 (£)	G3 (£)	G4 (£)
	MCPMP-NA/BK	Black mesh back, Black 4-leg pyramid swivel base	665	620	930	445	430	436	452	465
	MCPMA-NA/BK	Black mesh back, Black 4-leg pyramid swivel base with auto return	665	620	930	445	497	503	519	533
	MCPMP-OH/BK	Black mesh back, Black 4-leg pyramid swivel base, with fixed plastic armrests (pair)	665	620	930	445	479	486	501	515
	MCPMA-OH/BK	Black mesh back, Black 4-leg pyramid swivel base with auto return, with fixed plastic armrests (pair)	665	620	930	445	546	554	569	582

Palermo

Canteen / meeting / conference chairs

Huge choice
of fabrics
available!



Ideal for breakout areas and canteens the Palermo chair's contemporary moulded shape and subtle muted colour choice bring vitality to any workspace.

Choose the standard form or with integrated armrests, both stackable up to 4 chairs high. The solid plastic finish makes them easy to keep clean.

Made entirely from environmentally sustainable polypropylene

Palermo chairs are manufactured from a mixture of recycled materials: approx. 50% regenerated industrial polymers and 50% recycled consumer waste such as packaging, textiles and toys. Once these materials are processed the resulting polypropylene is reinforced with glass fibre.



Range

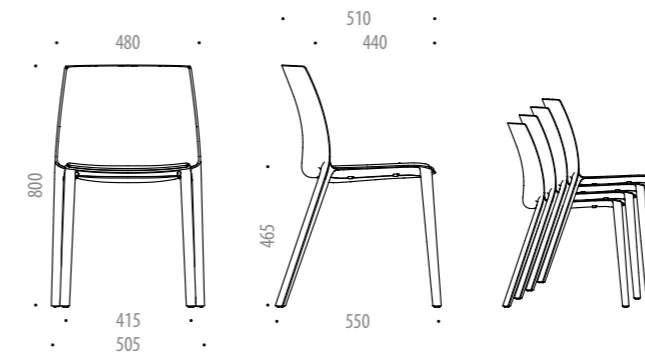

Integral armrests

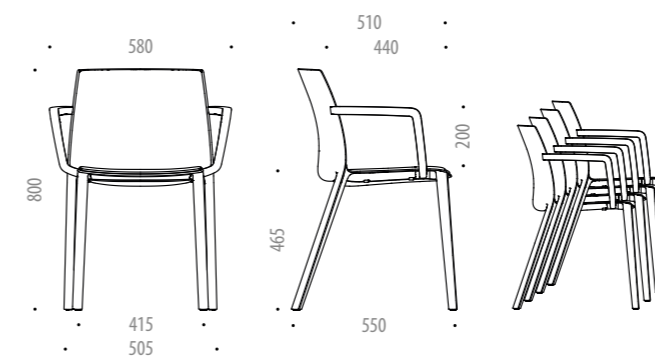

Technical

- Option with integrated armrest
- Upholstered seat pad foam (polyurethane)

Materials

G1 Fabric

Camira Era
Camira Target
Fidivi Bondai
Gabriel Chili
Gabriel Event
Gabriel Just
Gabriel Tonal

G2 Fabric

Camira Quest
Camira Vita
Camira X2
Camira Xtreme
Chieftain Just Colour
Gabriel Go Check
Gabriel Go Uni
Gabriel Runner
Gabriel Step
Gabriel Step Melange
Gabriel Cyber

G3 Fabric

Camira Aspect
Camira Chateau
Camira Oceanic
Gabriel Crisp
Gabriel Fighter
Gabriel Medley

G4 Fabric

Camira Blazer
Camira Regent
Camira Sumi
Camira Synergy
Gabriel Go Couture
Gabriel Rondo

Plastic

White (EM)
Dark Grey (E4)
Green (SC)
Pink (ST)
Teal (SD)

Eco friendly

	CODE	DESCRIPTION	WIDTH	DEPTH	HEIGHT	SEAT	RSP (£)
	SCPFP	Plastic seat / back	505	550	800	465	204

	SCPAP	Plastic seat / back, integral armrests	580	550	800	465	222
---	-------	--	-----	-----	-----	-----	------------

	CODE	DESCRIPTION	WIDTH	DEPTH	HEIGHT	SEAT	G1 (£)	G2 (£)	G3 (£)	G4 (£)
	SCPFF	Upholstered seat, plastic back	505	550	800	465	288	293	303	312

	SCPAPF	Upholstered seat, plastic back, integral armrests	580	550	800	465	306	311	321	330
--	--------	---	-----	-----	-----	-----	------------	------------	------------	------------

Seattle

Canteen / meeting / conference chairs

Huge choice
of fabrics
available!



The Seattle conference chair with its slim profile is a subtle addition to the modern workspace.

Stackable up to 4 high, the practical design makes it a flexible option for conferences, breakout spaces or canteens. The choice of tones add subtle colour with a plastic finish that makes this chair easy to sanitise.

Range

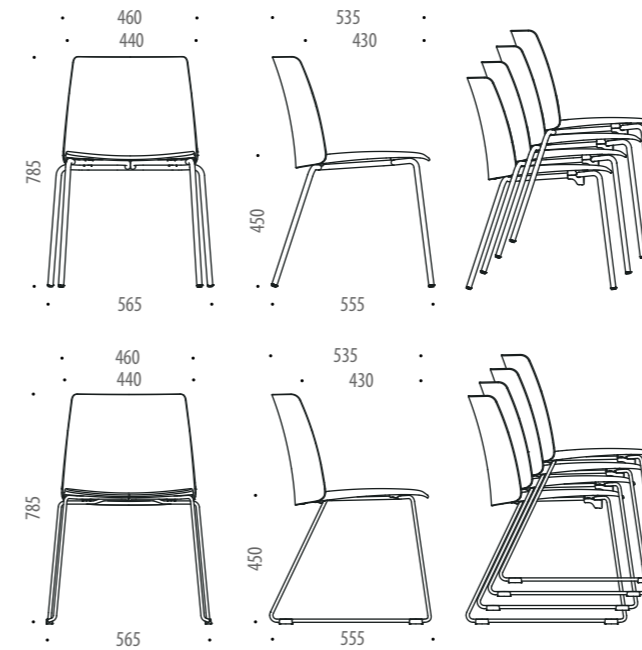

Technical



- Plastic and metal legs/base in 4 different colours
- Upholstered seat pad foam made of polyurethane

Materials

G1 Fabric

Camira Era
Camira Target
Fidivi Bondai
Gabriel Chili 
Gabriel Event
Gabriel Just 
Gabriel Tonal 



G2 Fabric

Camira Quest 
Camira Vita
Camira X2
Camira Xtreme 
Chieftain Just Colour
Gabriel Go Check
Gabriel Go Uni
Gabriel Runner 
Gabriel Step
Gabriel Step Melange
Gabriel Cyber 

G3 Fabric

Camira Aspect
Camira Chateau
Camira Oceanic 
Gabriel Crisp
Gabriel Fighter
Gabriel Medley



G4 Fabric



Camira Blazer 
Camira Regent
Camira Sumi
Camira Synergy
Gabriel Go Couture
Gabriel Rondo 

Plastic shell / metal frame

White (EM)
Dark Grey (E4)
Green (SC)
Pink (ST)

 Eco friendly

	CODE	DESCRIPTION	WIDTH	DEPTH	HEIGHT	SEAT	RSP (£)
	SCSFP	Plastic seat / back, steel 4 leg base	565	555	785	450	190
	SCSSP	Plastic seat / back, steel sled base	565	555	785	450	207
	SCSLP	Plastic seat / back, steel sled base with linking feet	565	555	785	450	207

	CODE	DESCRIPTION	WIDTH	DEPTH	HEIGHT	SEAT	G1 (£)	G2 (£)	G3 (£)	G4 (£)
	SCSFF	Upholstered seat / plastic back, steel 4 leg base	565	555	785	450	261	266	277	286
	SCSSF	Upholstered seat / plastic back, steel sled base	565	555	785	450	278	282	293	303
	SCSLF	Upholstered seat / plastic back, steel sled base with linking feet	565	555	785	450	278	283	294	303

Eva 2

Mesh back task chairs + Executive task chairs



Eva 2 mesh back task chairs are an ideal solution for any size office. With a choice of white, grey or black mesh, black or white plastic body and a wide variety of fabric seat finishes you can easily match Eva 2 chairs to any interior design.

Task chairs include a synchro mechanism with side tension option, optional lumbar support and either a plastic or polished aluminium base. A choice of armrests with different levels of adjustment allow you to match Eva 2 to your exact ergonomic requirements.



The executive chair comes with a soft PU headrest.

Range

Executive

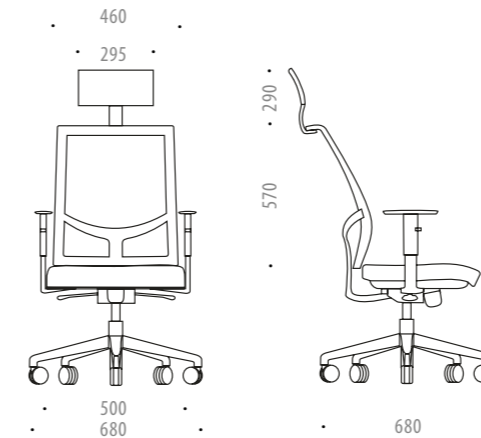

Task chair

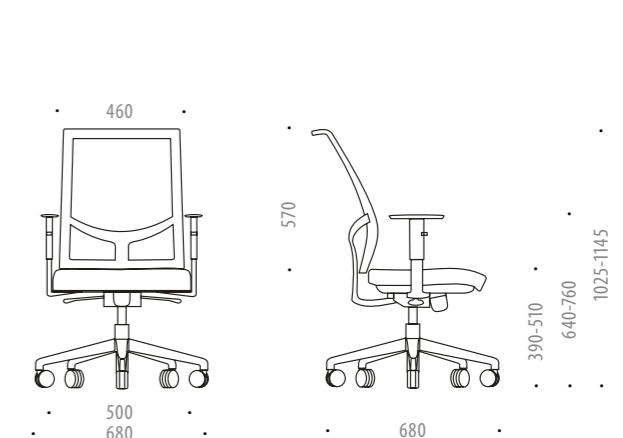

Technical

Seat

- Foam made of polyurethane

Back

- Black or white plastic frame
- Upholstered with mesh

Lumbar support

- Height adjustable
- Made of white or black plastic

Headrest

- Fixed;
- Made of soft polyurethane.

Armrests

- Fixed black plastic armrests
- Height adjustable, black or white plastic
- Height adjustable black plastic with soft PU pads
- 2D (two directions) adjustable, polished aluminium, upper part coated with soft touch PU pads, adjustable in height and top moving forward and backward

Mechanism

- Epron: mechanism with synchronized movement of seat and back, 5 locking positions of the backrest, hand wheel tension adjustment
- Epron Plus: synchronized mechanism, 5 locking positions of the backrest, tension adjustment with quick side tension regulation by lever

Gas lift

- Chrome or black colour
- 120mm run range

Bases

- 5-star polished aluminium, black plastic with fibreglass
- External Ø680mm

Castors

- Ø65mm rubber freewheel castors for hard floor
- Ø65mm PA freewheel castors for soft floor

Materials

G1 Fabric*

Berta
Camira Era
Bondai

G2 Fabric*

Leather Look
Step/Step Melange
Camira Xtreme ♻️









G3 Fabric*









Velito
Camira Synergy









Mesh





Black (GM8)
Light Grey (GM9)
Black (PM1)
Grey (PM2)
White (PM3)

♻️ Eco friendly

	CODE	DESCRIPTION	WIDTH	DEPTH	HEIGHT	SEAT	G1 (£)	G2 (£)	G3 (£)
	SIC620	Task chair, plastic chair body in white, synchro mechanism, 5-star plastic base with fibreglass	680	680	1025-1145	410-530	709	715	733
	SIC720	Task chair with lumbar support, plastic chair body in white, synchro mechanism, 5-star plastic base with fibreglass	680	680	1025-1145	410-530	730	735	760
	SIC820	Task chair, plastic chair body in white, synchro mechanism, 5-star polished aluminium base	680	680	1025-1145	410-530	786	792	816
	SIC920	Task chair with lumbar support, plastic chair body in white, synchro mechanism, 5-star polished aluminium base	680	680	1025-1145	410-530	806	812	836
	SIC220	Task chair, plastic chair body in black, synchro mechanism, 5-star plastic base with fibreglass	680	680	1025-1145	410-530	666	678	713
	SIC430	Task chair with lumbar support, plastic chair body in black, synchro mechanism, 5-star plastic base with fibreglass	680	680	1025-1145	410-530	668	682	715
	SIC530	Task chair, plastic chair body in black, synchro mechanism, 5-star polished aluminium base	680	680	1025-1145	410-530	761	771	785
	SIC630	Task chair with lumbar support, plastic chair body in black, synchro mechanism, 5-star polished aluminium base	680	680	1025-1145	410-530	762	775	786

	CODE	DESCRIPTION	WIDTH	DEPTH	HEIGHT	SEAT	G1 (£)	G2 (£)	G3 (£)
	SIC030	Task chair, plastic chair body in white, synchro mechanism with side tension, 5-star plastic base with fibreglass	680	680	1025-1145	410-530	766	778	801
	SIC130	Task chair with lumbar support, plastic chair body in white, synchro mechanism with side tension, 5-star plastic base with fibreglass	680	680	1025-1145	410-530	768	775	804
	SIC230	Task chair, plastic chair body in white, synchro mechanism with side tension, 5-star polished aluminium base	680	680	1025-1145	410-530	837	861	878
	SIC330	Task chair with lumbar support, plastic chair body in white, synchro mechanism with side tension, 5-star polished aluminium base	680	680	1025-1145	410-530	851	862	886
	SIC520	Task chair, plastic chair body in black, synchro mechanism with side tension, 5-star plastic base with fibreglass	680	680	1025-1145	410-530	725	738	766
	SIC730	Task chair with lumbar support, plastic chair body in black, synchro mechanism with side tension, 5-star plastic base with fibreglass	680	680	1025-1145	410-530	727	733	768
	SIC830	Task chair, plastic chair body in black, synchro mechanism with side tension, 5-star polished aluminium base	680	680	1025-1145	410-530	819	831	849
	SIC930	Task chair with lumbar support, plastic chair body in black, synchro mechanism with side tension, 5-star polished aluminium base	680	680	1025-1145	410-530	821	839	851

	CODE	DESCRIPTION	WIDTH	DEPTH	HEIGHT	SEAT	G1 (£)	G2 (£)	G3 (£)
	SID030	Executive chair with soft polyurethane headrest, plastic chair body in black, synchro mechanism, 5-star black base, gas lift	680	680	1250-1370	410-530	743	743	785
	SID230	Executive chair with lumbar support and soft polyurethane headrest, plastic chair body in black, synchro mechanism, 5-star black base, gas lift	680	680	1250-1370	410-530	739	750	786
	SID330	Executive chair with soft polyurethane headrest, plastic chair body in black, synchro mechanism, 5-star polished aluminium base	680	680	1250-1370	410-530	831	854	867
	SID430	Executive chair with lumbar support and soft polyurethane headrest, plastic chair body in black, synchro mechanism, 5-star polished aluminium base	680	680	1250-1370	410-530	844	856	862
	SID130	Executive chair with soft polyurethane headrest, plastic chair body in black, synchro mechanism with side tension, 5-star black base, gas lift	680	680	1250-1370	410-530	796	801	837
	SID530	Executive chair with lumbar support and soft polyurethane headrest, synchro mechanism with side tension, 5-star black base, gas lift	680	680	1250-1370	410-530	792	804	844
	SID630	Executive chair with soft polyurethane headrest, synchro mechanism with side tension, 5-star polished aluminium base	680	680	1250-1370	410-530	895	908	913
	SID730	Executive chair with lumbar support and soft polyurethane headrest, synchro mechanism with side tension, 5-star polished aluminium base	680	680	1250-1370	410-530	898	904	915

	CODE	DESCRIPTION	WIDTH	DEPTH	HEIGHT	RSP (£)
	SZZ000-A	Pair of fixed plastic armrests	165	230	275	46
	SZZ008-A	Pair of fixed plastic armrests	190	300	250	86
	SZZ100-A	Pair of height adjustable plastic armrests, black	200	248	250-320	86
	SZZ100-E	Pair of height adjustable plastic armrests, white	200	248	250-320	102
	SZZ101-A	2D adjustable armrests with soft PU pads	160	230	300-395	139



Wind

Task + Meeting + High swivel chairs

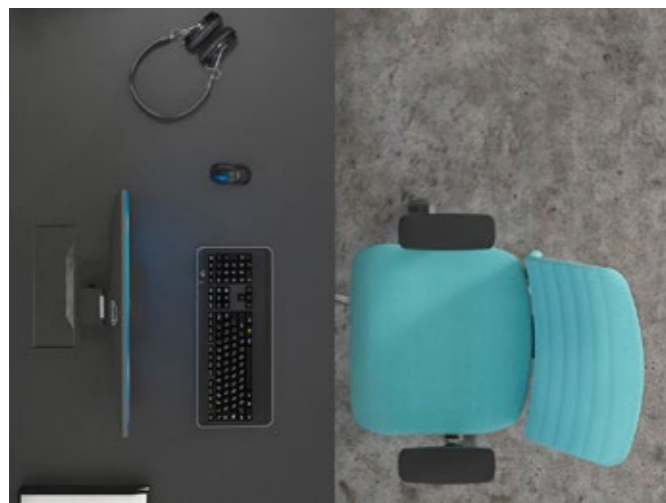

The Wind task chair is now available in 3 different versions: choose the backrest with regular and knitted mesh for a lighter and more breathable solution or fabric if you prefer a softer feel - same design without sacrificing any of its ergonomic features.

Wind has an instantly recognizable X-shape transparent lumbar support uniquely designed to enhance the chair's visual appeal and serve an important function. Its height can be adjusted and it conforms to the user's lumbar shape due to the elastic properties of silicone, providing exceptional comfort.

The high swivel chair is an elegant solution to match with reception desks, high tables and sit-stand desks. The ring-shaped adjustable-height legrest allows users to adjust the chair to their height, maintain a correct seating position and avoid unpleasant back and neck pain. Castors provide extra safety and stability, locking in place as you sit. The meeting chair is a welcoming tool to equip collaborative workplaces and increase productivity. Backrest and armrests form an original monobloc structure the upholstered seat and 4 different bases meet any flexibility and aesthetic needs.

Chair range

Task chairs

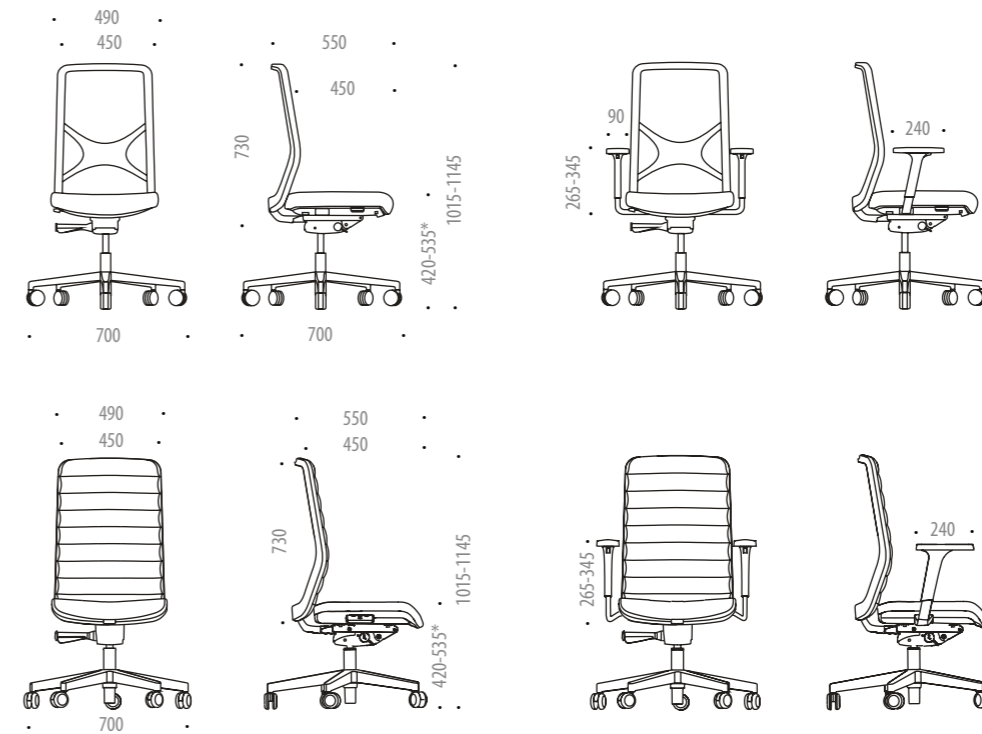

Meeting chairs

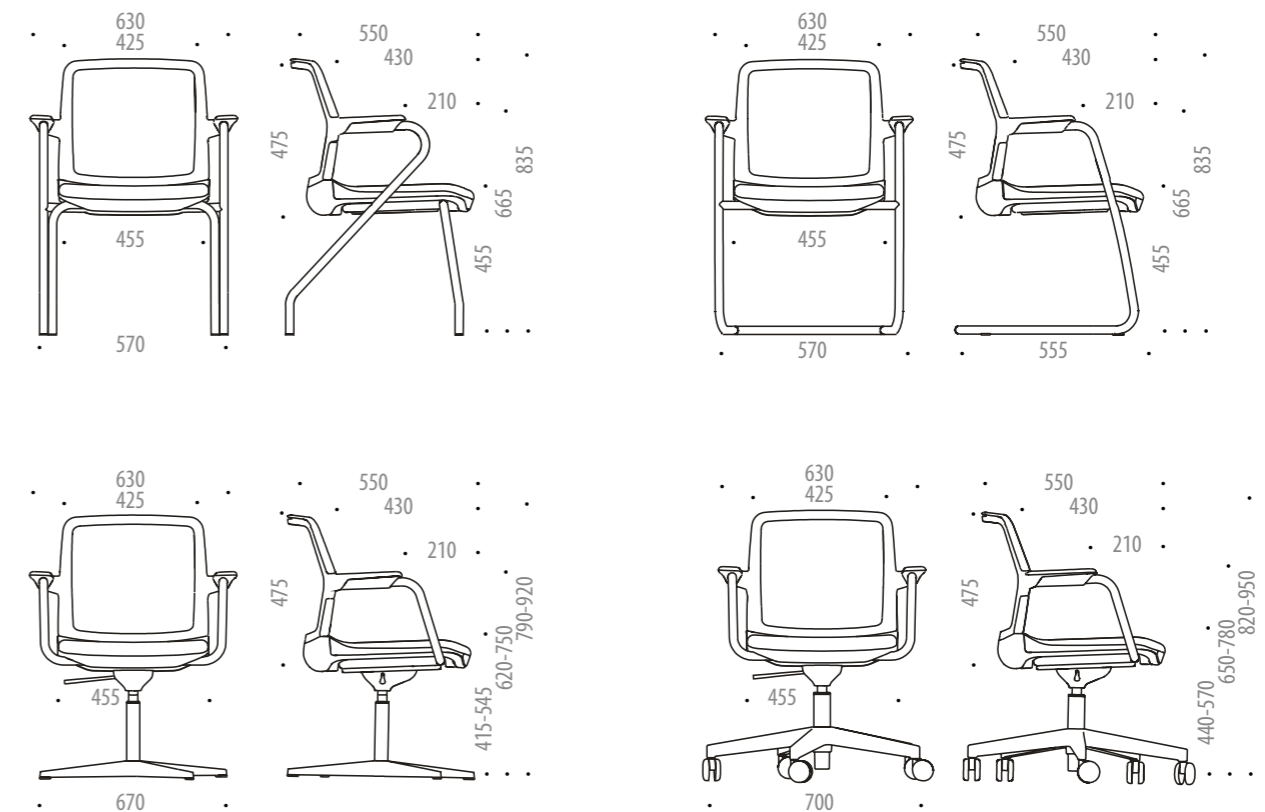

High swivel chairs

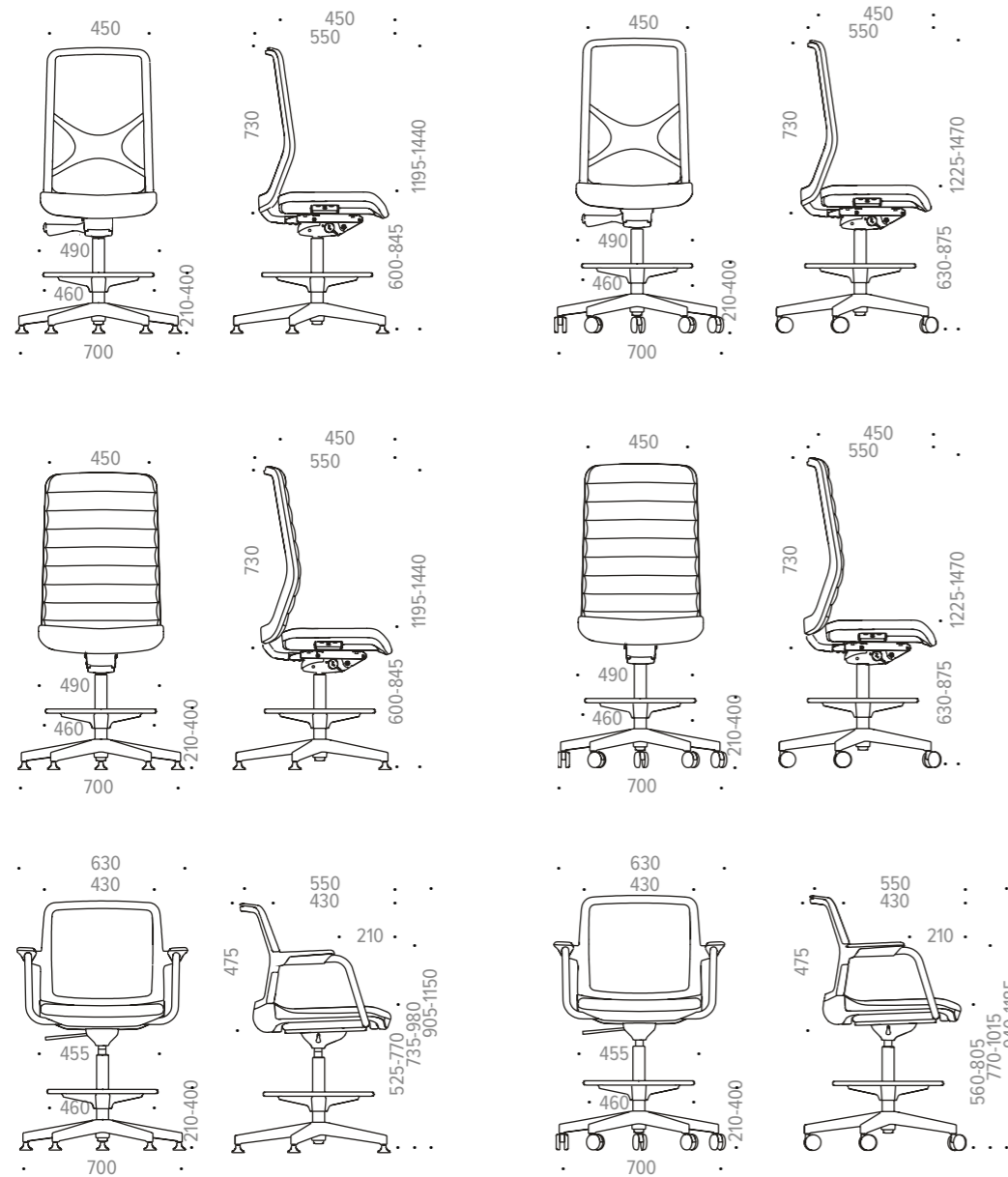

Materials

Fabric*

Berta
Camira Era
Bondai
Leather Look
Step/Step Melange
Camira Xtreme 
Valencia C5
Velito
Camira Synergy
Genuine Leather

Mesh

Micro Mesh (MM)
Knitted Mesh (KM)
Runner Mesh (RM)

 Eco friendly

Technical

TASK CHAIRS

Seat

- Fixed or depth adjustable (60mm run range)
- Lower part (inner and outer) made of PP (polypropylene)
- Foam made of polyurethane
- Fabric or leather look upholstered

Backrest

- Frame made of black or white plastic
- Mesh, fabric or leather look upholstered
- Inner foam made of polyurethane (fabric upholstery)

Lumbar support

- Height adjustable (80mm run range)
- Made of transparent silicone

Headrest

- Frame made of nylon plastic
- Soft part made of polyurethane
- Height adjustable (60mm run range)
- Fabric or leather look upholstered

Gas lift

- Chrome or black
- 130mm run range

Mechanism

- Weight-sensitive synchronized mechanism
- 3 backrest locking positions by push button

Bases

- 5-star polished aluminium base
- 5-star black or white fibreglass reinforced plastic base
- External Ø700mm

Castors

- Rubber freewheel castors for hard floor, Ø65mm
- PA freewheel castors for soft floor, Ø65mm

Armrests

- Fixed black plastic armrests
- 2D adjustable black plastic armrests
- 2D adjustable black plastic or white plastic armrests with polished aluminum lower part
- 2D height adjustable armrests (80mm run range), pad moves forward and backward (55mm range)
- 3D adjustable black plastic armrests
- 3D adjustable black plastic or white plastic armrests with polished aluminum lower part
- 3D height adjustable armrests (80mm run range), width adjustable (37mm run range), pad moves forward and backward (55mm range)
- All armrests upper part coated with PU pads, soft touch

MEETING CHAIRS

Seat

- Fixed, lower part (inner and outer) made of PP
- Foam made of polyurethane
- Fabric or leather look upholstered

Backrest

- Frame made of black or white plastic, mesh upholstered

Armrests

- Chrome frame covered with black or white plastic
- Armrest pad fixed, made of plastic

Mechanism

- Polished or black
- Fixed, height adjustment by side lever

Gas lift

- Chrome or black colour, 130mm run range

Bases

- 5-star polished aluminium base
- 5-star black or white fibreglass reinforced plastic base
- 5-star external Ø700mm
- 4-star polished or black powder-coated aluminium base
- 4-star external Ø670mm
- Four legs metal tube frame, chrome or powder coated
- Cantilever metal tube frame, chrome or powder-coated

Castors and glides

- Ø65mm rubber freewheel castors for hard floor (5-star base)
- Ø65mm PA freewheel castors for soft floor, (5-star base)
- Glides for hard floor (cantilever and 4-leg base)
- Glides for soft floor (cantilever and 4-leg base)

HIGH SWIVEL CHAIRS

Seat

- Fixed
- Lower part (inner and outer) made of PP
- Foam made of polyurethane
- Fabric or leather look upholstered

Backrest

- Frame made of black or white plastic
- Mesh, fabric or leather look upholstered
- Inner foam made of polyurethane (fabric upholstery)

Lumbar support

- Height adjustable (80mm run range)
- Made of transparent silicone

Bases

- 5-star polished aluminium base
- 5-star black or white fibreglass reinforced plastic base
- External Ø700mm

Foot ring

- Fixed with gas lift
- Easy height adjustable
- Black plastic body with chrome-finished ring, Ø460mm

Gas lift

- Chrome or black colour
- 245mm run range

Castors





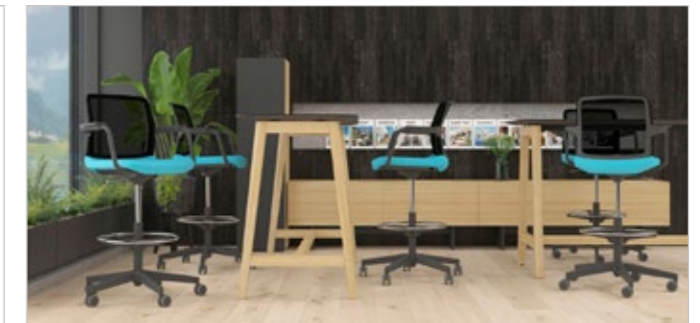
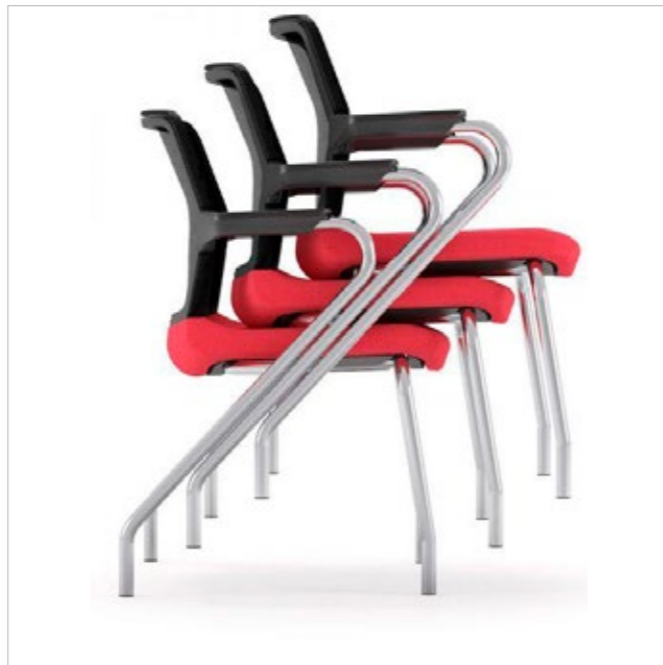

- Rubber freewheel castors with sit stop brake for hard floor, Ø65mm
- PA (polyamide) freewheel castors with sit stop brake for soft floor, Ø65mm
- PP fixed glides, Ø50mm, for soft floors

Armrests

- Fixed black or plastic armrests;
- 2D adjustable black plastic armrests;
- 2D adjustable black plastic or white plastic armrests with polished aluminium lower part;
- 2D height adjustable (80mm run range), pad moves forward and backward (55mm range)
- 3D adjustable black plastic armrests
- 3D adjustable black plastic or white plastic armrests with polished aluminium lower part
- 3D armrests height adjustable (80mm run range), width adjustable (37mm run range), pad moves forward and backward (55mm range)
- All armrests upper part is PU coated pads, soft touch



G1: Berta / Era / Bondai Fabric + Runner Mesh / Micro Mesh
 G2: Berta / Era / Bondai Fabric + Knitted Mesh
 G3: Leather Look / Step/Step Melange / Xtreme Fabric + Runner Mesh / Micro Mesh
 G4: Leather Look / Step/Step Melange / Xtreme Fabric + Knitted Mesh
 G5: Valencia C5 / Velito / Synergy Fabric + Runner Mesh / Micro Mesh
 G6: Valencia C5 / Velito / Synergy Fabric + Knitted Mesh







	CODE	DESCRIPTION	WIDTH	DEPTH	HEIGHT	SEAT	G1 (£)	G2 (£)	G3 (£)	G4 (£)	G5 (£)	G6 (£)
	SWA040	Task chair with black backrest and black plastic base	700	700	1015-1145	420-535	886	903	891	909	914	940
	SWA050	with sliding seat					954	972	960	972	983	1,006
	SWA140	Task chair with black backrest and polished aluminium base	700	700	1015-1145	420-535	962	985	967	991	997	1,014
	SWA150	with sliding seat					1,025	1,055	1,036	1,055	1,065	1,083
	SWA240	Task chair with white backrest and white plastic base	700	700	1015-1145	420-535	909	921	909	926	944	955
	SWA250	with sliding seat					955	973	962	985	997	1,008
	SWA340	Task chair with white backrest and polished aluminium base	700	700	1015-1145	420-535	991	1,003	997	1,008	1,021	1,037
	SWA350	with sliding seat					1,037	1,056	1,044	1,062	1,074	1,090
	SWR040	High swivel chair with black backrest and black plastic base with castors	700	700	1225-1470	630-875	1,137	1,167	1,150	1,180	1,173	1,203
	SWR140	High swivel chair with black backrest and polished aluminium base with castors	700	700	1225-1470	630-875	1,220	1,250	1,233	1,256	1,256	1,284







	CODE	DESCRIPTION	WIDTH	DEPTH	HEIGHT	SEAT	G1 (£)	G2 (£)	G3 (£)	G4 (£)	G5 (£)	G6 (£)
	SWR240	High swivel chair with white backrest and white plastic base with castors	700	700	1225-1470	630-875	1,196	1,219	1,207	1,230	1,230	1,254
	SWR340	High swivel chair with white backrest and polished aluminium base with castors	700	700	1225-1470	630-875	1,272	1,307	1,290	1,319	1,313	1,343
	SWG040	High swivel chair with black backrest and black plastic base with glides	700	700	1195-1440	600-845	1,132	1,156	1,138	1,168	1,162	1,191
	SWG140	High swivel chair with mesh backrest, black plastic frame and polished aluminium base with glides	700	700	1195-1440	600-845	1,209	1,239	1,227	1,250	1,244	1,268
	SWG240	High swivel chair with mesh backrest, white plastic frame and base with glides	700	700	1195-1440	600-845	1,150	1,180	1,161	1,190	1,186	1,213
	SWG340	High swivel chair with mesh backrest, white plastic frame and polished aluminium base with glides	700	700	1195-1440	600-845	1,238	1,261	1,250	1,280	1,261	1,303







* Not every fabric from these ranges is available on standard Narbutas lead times - please see Fabrics section at back of price list for details
 All Wind task/high swivel chairs have a lockable weight sensitive mechanism

All Wind task/high swivel chairs have a lockable weight sensitive mechanism

G1: Berta / Era / Bondai
G2: Leather Look / Step/Step Melange / Xtreme
G3: Velito / Synergy

	CODE	DESCRIPTION	WIDTH	DEPTH	HEIGHT	SEAT	G1 (£)	G2 (£)	G3 (£)
	SWA440	Task chair with fabric backrest, black plastic frame and base	700	700	1015-1145	420-535	955	1,008	1,090
	SWA450	with sliding seat					1,003	1,062	1,137
	SWA540	Task chair with fabric backrest, black plastic frame and polished aluminium base	700	700	1015-1145	420-535	1,037	1,097	1,173
	SWA550	with sliding seat					1,090	1,143	1,227
	SWA640	Task chair with fabric backrest, white plastic frame and base	700	700	1015-1145	420-535	973	1,037	1,109
	SWA650	with sliding seat					1,033	1,086	1,161
	SWA740	Task chair with fabric backrest, white plastic frame and polished aluminium base	700	700	1015-1145	420-535	1,062	1,120	1,190
	SWA750	with sliding seat					1,109	1,167	1,243
	SWR440	High swivel chair with fabric backrest, black plastic frame and base with castors	700	700	1225-1470	630-875	1,225	1,272	1,354
	SWR540	High swivel chair with fabric backrest, black plastic frame and polished aluminium base with castors	700	700	1225-1470	630-875	1,302	1,354	1,437

	CODE	DESCRIPTION	WIDTH	DEPTH	HEIGHT	SEAT	G1 (£)	G2 (£)	G3 (£)
	SWR640	High swivel chair with fabric backrest, white plastic frame and base with castors	700	700	1225-1470	630-875	1,260	1,319	1,395
	SWR740	High swivel chair with fabric backrest, white plastic frame and polished aluminium base with castors	700	700	1225-1470	630-875	1,348	1,407	1,484
	SWG440	High swivel chair with fabric backrest, black plastic frame and base with glides	700	700	1195-1440	600-845	1,192	1,253	1,330
	SWG540	High swivel chair with fabric backrest, black plastic frame and polished aluminium base with glides	700	700	1195-1440	600-845	1,270	1,334	1,410
	SWG640	High swivel chair with fabric backrest, white plastic frame and base with glides	700	700	1195-1440	600-845	1,241	1,299	1,371
	SWG740	High swivel chair with fabric backrest, white plastic frame and polished aluminium base with glides	700	700	1195-1440	600-845	1,323	1,375	1,453





	CODE	DESCRIPTION	WIDTH	DEPTH	HEIGHT	RSP (£)
	SZZ001-A	Pair of fixed black plastic armrests	230	195	265-345	133
	SZZ102-A	Pair of 2D adjustable black plastic armrests with PU soft touch pads <i>Adjust height and distance from backrest</i>	230	195	265-345	186
	SZZ103-A	Pair of 2D adjustable black plastic armrests with black PU soft touch pads and aluminium base <i>Adjust height and distance from backrest</i>	230	195	265-345	232
	SZZ110-E	Pair of 2D adjustable white plastic armrests with black PU soft touch pads and aluminium base <i>Adjust height and distance from backrest</i>	230	195	265-345	245
	SZZ111-A	Pair of 3D adjustable black plastic armrests with black PU soft touch pads <i>Adjust height, distance from backrest and width (distance from seat)</i>	230	195	265-345	221
	SZZ112-A	Pair of 3D adjustable black plastic armrests with black PU soft touch pads and aluminium base <i>Adjust height, distance from backrest and width (distance from seat)</i>	230	195	265-345	280
	SZZ113-E	Pair of 3D adjustable white plastic armrests with black PU soft touch pads and aluminium base <i>Adjust height, distance from backrest and width (distance from seat)</i>	230	195	265-345	292

G1: Berta / Era / Bondai
G2: Leather Look / Step/Step Melange / Xtreme

G3: Valencia C5 / Velito / Synergy
G4: Genuine Leather

	CODE	DESCRIPTION	WIDTH	DEPTH	HEIGHT	G1 (£)	G2 (£)	G3 (£)	G4 (£)
	SZZ006	Adjustable headrest	280	153	295	109	116	116	121

G1: Berta / Era / Bondai Fabric + Runner Mesh / Micro Mesh
G2: Berta / Era / Bondai Fabric + Knitted Mesh
G3: Leather Look / Step/Step Melange / Xtreme Fabric + Runner Mesh / Micro Mesh
G4: Leather Look / Step/Step Melange / Xtreme Fabric + Knitted Mesh
G5: Valencia C5 / Velito / Synergy Fabric + Runner Mesh / Micro Mesh
G6: Valencia C5 / Velito / Synergy Fabric + Knitted Mesh

	CODE	DESCRIPTION	WIDTH	DEPTH	HEIGHT	SEAT	G1 (£)	G2 (£)	G3 (£)	G4 (£)	G5 (£)	G6 (£)
	SWA414/P1	Meeting chair with black backrest, plastic armrest pads, black steel frame, black plastic base with castors	700	700	820-950	440-570	840	870	858	889	881	912
	SWA414/P2	Soft pads					893	923	905	941	934	964
	SWA514/P1	Meeting chair with black backrest, plastic armrest pads, black steel frame, polished aluminium base with castors	700	700	820-950	440-570	946	986	970	999	986	1,023
	SWA514/P2	Soft pads					999	1,035	1,028	1,058	1,046	1,076
	SWA014/P1	Meeting chair with black backrest, plastic armrest pads, chromed steel frame, black plastic base with castors	700	700	820-950	440-570	858	893	881	912	899	934
	SWA014/P2	Soft pads					912	941	934	964	952	986
	SWA114/P1	Meeting chair with black backrest, plastic armrest pads, chromed steel frame, polished aluminium base with castors	700	700	820-950	440-570	976	1,005	986	1,028	1,017	1,053
	SWA114/P2	Soft pads					1,028	1,063	1,039	1,076	1,070	1,106

G1: Berta / Era / Bondai Fabric + Runner Mesh / Micro Mesh





G2: Berta / Era / Bondai Fabric + Knitted Mesh





G3: Leather Look / Step/Step Melange / Xtreme Fabric + Runner Mesh / Micro Mesh

G4: Leather Look / Step/Step Melange / Xtreme Fabric + Knitted Mesh

G5: Valencia C5 / Velito / Synergy Fabric + Runner Mesh / Micro Mesh

G6: Valencia C5 / Velito / Synergy Fabric + Knitted Mesh

	CODE	DESCRIPTION	WIDTH	DEPTH	HEIGHT	SEAT	G1 (£)	G2 (£)	G3 (£)	G4 (£)	G5 (£)	G6 (£)
	SWA614/P1	Meeting chair with white backrest, plastic armrest pads, white steel frame, white plastic base with castors	700	700	820-950	440-570	875	912	893	923	916	946
	SWA614/P2	Soft pads					929	964	941	976	970	999
	SWA714/P1	Meeting chair with white backrest, plastic armrest pads, white steel frame, polished aluminium base with castors	700	700	820-950	440-570	970	999	993	1,023	1,010	1,039
	SWA714/P2	Soft pads					1,023	1,053	1,039	1,082	1,063	1,099
	SWA214/P1	Meeting chair with white backrest, plastic armrest pads, chromed steel frame, white plastic base with castors	700	700	820-950	440-570	899	929	916	952	941	976
	SWA214/P2	Soft pads					946	982	970	1,005	986	1,028
	SWA314/P1	Meeting chair with white backrest, plastic armrest pads, chromed steel frame, polished aluminium base with castors	700	700	820-950	440-570	986	1,023	999	1,035	1,028	1,058
	SWA314/P2	Soft pads					1,035	1,070	1,053	1,087	1,076	1,110
	SWA334/P1	Meeting chair with black backrest, plastic armrest pads, black steel frame with black plastic base with glides	670	670	790-920	415-545	916	952	941	976	959	993
	SWA334/P2	Soft pads					970	1,005	993	1,028	1,010	1,039

	CODE	DESCRIPTION	WIDTH	DEPTH	HEIGHT	SEAT	G1 (£)	G2 (£)	G3 (£)	G4 (£)	G5 (£)	G6 (£)
	SWA434/P1	Meeting chair with black backrest, plastic armrest pads, black steel frame, polished aluminium base with glides	670	670	790-920	415-545	929	959	941	982	970	1,005
	SWA434/P2	Soft pads					982	1,017	993	1,028	1,023	1,058
	SWA034/P1	Meeting chair with black backrest, plastic armrest pads, chromed steel frame, black plastic base with glides	670	670	790-920	415-545	943	972	954	991	984	1,019
	SWA034/P2	Soft pads					996	1,032	1,007	1,043	1,037	1,073
	SWA134/P1	Meeting chair with black backrest, plastic armrest pads, chromed steel frame, polished aluminium base with glides	670	670	790-920	415-545	950	991	973	1,003	991	1,026
	SWA134/P2	Soft pads					1,003	1,037	1,026	1,055	1,044	1,079
	SWA534/P1	Meeting chair with white backrest, plastic armrest pads, white steel frame, polished aluminium base with glides	670	670	790-920	415-545	952	986	964	999	993	1,028
	SWA534/P2	Soft pads					999	1,039	1,017	1,053	1,039	1,082
	SWA234/P1	Meeting chair with white backrest, plastic armrest pads, chromed steel frame, polished aluminium base with glides	670	670	790-920	415-545	966	996	990	1,019	1,006	1,036
	SWA234/P2	Soft pads					1,019	1,048	1,036	1,073	1,059	1,096

G1: Berta / Era / Bondai Fabric + Runner Mesh / Micro Mesh





G2: Berta / Era / Bondai Fabric + Knitted Mesh





G3: Leather Look / Step/Step Melange / Xtreme Fabric + Runner Mesh / Micro Mesh

G4: Leather Look / Step/Step Melange / Xtreme Fabric + Knitted Mesh

G5: Valencia C5 / Velito / Synergy Fabric + Runner Mesh / Micro Mesh

G6: Valencia C5 / Velito / Synergy Fabric + Knitted Mesh

	CODE	DESCRIPTION	WIDTH	DEPTH	HEIGHT	SEAT	G1 (£)	G2 (£)	G3 (£)	G4 (£)	G5 (£)	G6 (£)
	SWA224/P1	Meeting chair with black backrest, plastic armrest pads, black steel cantilever frame with glides	570	555	835	455	649	686	662	696	686	715
	SWA224/P2	Soft pads					704	739	715	749	739	774
	SWA024/P1	Meeting chair with black backrest, plastic armrest pads, chromed steel cantilever frame with glides	570	555	835	455	704	733	720	749	749	779
	SWA024/P2	Soft pads					749	786	774	802	797	832
	SWA324/P1	Meeting chair with white backrest, plastic armrest pads, white steel cantilever frame with glides	570	555	835	455	662	692	673	709	696	726
	SWA324/P2	Soft pads					709	744	726	762	749	779
	SWA124/P1	Meeting chair with white backrest, plastic armrest pads, chromed steel cantilever frame with glides	570	555	835	455	715	749	733	762	757	792
	SWA124/P2	Soft pads					768	797	786	816	809	839

	CODE	DESCRIPTION	WIDTH	DEPTH	HEIGHT	SEAT	G1 (£)	G2 (£)	G3 (£)	G4 (£)	G5 (£)	G6 (£)
	SWA204/P1	Meeting chair with black backrest, plastic armrest pads, black steel legs with glides	570	540	835	455	662	696	673	709	696	726
	SWA204/P2	Soft pads					715	749	733	768	749	786
	SWA004/P1	Meeting chair with black backrest, plastic armrest pads, chromed steel legs with glides	570	540	835	455	704	739	726	757	749	786
	SWA004/P2	Soft pads					757	792	779	809	802	839
	SWA304/P1	Meeting chair with white backrest, plastic armrest pads, white steel legs with glides	570	540	835	455	668	704	686	720	704	744
	SWA304/P2	Soft pads					726	757	744	774	757	792
	SWA104/P1	Meeting chair with white backrest, plastic armrest pads, chromed steel legs with glides	570	540	835	455	726	757	744	774	767	797
	SWA104/P2	Soft pads					779	809	797	826	820	850

G1: Berta / Era / Bondai Fabric + Runner Mesh / Micro Mesh





G2: Berta / Era / Bondai Fabric + Knitted Mesh



G3: Leather Look / Step/Step Melange / Xtreme Fabric + Runner Mesh / Micro Mesh

G4: Leather Look / Step/Step Melange / Xtreme Fabric + Knitted Mesh





G5: Valencia C5 / Velito / Synergy Fabric + Runner Mesh / Micro Mesh





G6: Valencia C5 / Velito / Synergy Fabric + Knitted Mesh

	CODE	DESCRIPTION	WIDTH	DEPTH	HEIGHT	SEAT	G1 (£)	G2 (£)	G3 (£)	G4 (£)	G5 (£)	G6 (£)
	SWA454/P1	High swivel chair with black backrest, plastic armrest pads, black steel frame, black plastic base with castors	700	700	940-1185	560-805	1,048	1,084	1,073	1,101	1,089	1,126
	SWA454/P2	Soft pads					1,101	1,137	1,126	1,161	1,142	1,179
	SWA554/P1	High swivel chair with black backrest, plastic armrest pads, black steel frame, polished aluminium base with castors	700	700	940-1185	560-805	1,192	1,222	1,210	1,240	1,234	1,270
	SWA554/P2	Soft pads					1,253	1,276	1,263	1,299	1,293	1,322
	SWA054/P1	High swivel chair with black backrest, plastic armrest pads, chromed steel frame, black plastic base with castors	700	700	940-1185	560-805	1,087	1,123	1,106	1,134	1,129	1,163
	SWA054/P2	Soft pads					1,139	1,169	1,157	1,187	1,182	1,210
	SWA154/P1	High swivel chair with black backrest, plastic armrest pads, chromed steel frame, polished aluminium base with castors	700	700	940-1185	560-805	1,217	1,245	1,234	1,270	1,263	1,293
	SWA154/P2	Soft pads					1,263	1,304	1,286	1,322	1,316	1,346

	CODE	DESCRIPTION	WIDTH	DEPTH	HEIGHT	SEAT	G1 (£)	G2 (£)	G3 (£)	G4 (£)	G5 (£)	G6 (£)
	SWA654/P1	High swivel chair with white backrest, plastic armrest pads, white steel frame, white plastic base with castors	700	700	940-1185	560-805	1,106	1,139	1,123	1,158	1,152	1,182
	SWA654/P2	Soft pads					1,158	1,192	1,176	1,205	1,200	1,240
	SWA754/P1	High swivel chair with white backrest, plastic armrest pads, white steel frame, polished aluminium base with castors	700	700	940-1185	560-805	1,187	1,217	1,205	1,245	1,229	1,263
	SWA754/P2	Soft pads					1,240	1,270	1,259	1,293	1,282	1,316
	SWA254/P1	High swivel chair with white backrest, plastic armrest pads, chromed steel frame, white plastic base with castors	700	700	940-1185	560-805	1,143	1,173	1,167	1,202	1,184	1,220
	SWA254/P2	Soft pads					1,198	1,225	1,213	1,255	1,238	1,273

G1: Berta / Era / Bondai Fabric + Runner Mesh / Micro Mesh
 G2: Berta / Era / Bondai Fabric + Knitted Mesh
 G3: Leather Look / Step/Step Melange / Xtreme Fabric + Runner Mesh / Micro Mesh
 G4: Leather Look / Step/Step Melange / Xtreme Fabric + Knitted Mesh
 G5: Valencia C5 / Velito / Synergy Fabric + Runner Mesh / Micro Mesh
 G6: Valencia C5 / Velito / Synergy Fabric + Knitted Mesh

	CODE	DESCRIPTION	WIDTH	DEPTH	HEIGHT	SEAT	G1 (£)	G2 (£)	G3 (£)	G4 (£)	G5 (£)	G6 (£)
	SWA354/P1	High swivel chair with white backrest, plastic armrest pads, chromed steel frame, polished aluminium base with castors	700	700	940-1185	560-805	1,210	1,245	1,229	1,259	1,253	1,286
	SWA354/P2	Soft pads					1,263	1,299	1,282	1,311	1,305	1,334
	SWA464/P1	High swivel chair with black backrest, plastic armrest pads, black steel frame, black plastic base with glides	700	700	905-1150	525-770	1,048	1,084	1,073	1,101	1,089	1,126
	SWA464/P2	Soft pads					1,101	1,137	1,126	1,161	1,142	1,179
	SWA564/P1	High swivel chair with black backrest, plastic armrest pads, black steel frame, polished aluminium base with glides	700	700	905-1150	525-770	1,158	1,200	1,176	1,210	1,200	1,229
	SWA564/P2	Soft pads					1,217	1,245	1,234	1,270	1,253	1,286
	SWA064/P1	High swivel chair with black backrest, plastic armrest pads, chromed steel frame, black plastic base with glides	700	700	905-1150	525-770	1,090	1,120	1,101	1,137	1,126	1,161
	SWA064/P2	Soft pads					1,137	1,179	1,155	1,190	1,179	1,213

	CODE	DESCRIPTION	WIDTH	DEPTH	HEIGHT	SEAT	G1 (£)	G2 (£)	G3 (£)	G4 (£)	G5 (£)	G6 (£)
	SWA164/P1	High swivel chair with black backrest, plastic armrest pads, chromed steel frame, polished aluminium base with glides	700	700	905-1150	525-770	1,289	1,317	1,305	1,346	1,330	1,365
	SWA164/P2	Soft pads					1,346	1,375	1,365	1,394	1,388	1,423
	SWA664/P1	High swivel chair with white backrest, plastic armrest pads, white steel frame, white plastic base with glides	700	700	905-1150	525-770	1,101	1,137	1,120	1,150	1,143	1,179
	SWA664/P2	Soft pads					1,155	1,190	1,173	1,208	1,198	1,231
	SWA764/P1	High swivel chair with white backrest, plastic armrest pads, white steel frame, polished aluminium base with glides	700	700	905-1150	525-770	1,271	1,305	1,289	1,317	1,312	1,346
	SWA764/P2	Soft pads					1,322	1,358	1,341	1,369	1,365	1,399
	SWA264/P1	High swivel chair with mesh backrest, plastic armrest pads, chromed steel frame, white plastic base with glides	700	700	905-1150	525-770	1,218	1,253	1,229	1,264	1,259	1,289
	SWA264/P2	Soft pads					1,264	1,299	1,282	1,317	1,305	1,346
	SWA364/P1	High swivel chair with white backrest, plastic armrest pads, chromed steel frame, polished aluminium base with glides	700	700	905-1150	525-770	1,299	1,330	1,317	1,352	1,346	1,375
	SWA364/P2	Soft pads					1,346	1,388	1,369	1,406	1,394	1,428

North Cape

Task + Executive + Meeting + Conference chairs



The North Cape chair family is composed of stylish, sophisticated and functional executive, task, meeting and conference chairs. The range joins executive, working and meeting areas as well as reception and guest areas by uniting, delicate style.

Task chair tension adjustment

This function allows you to control how easily the chair tilts, depending on your weight and the force that is being used to lean back.

Task chair knee-tilt mechanism with centered axis

The task chair backrests and seats are joined together so when you lean back, the whole chair tilts. This mechanism allows you to lean back without lifting your feet from the ground, avoiding pressure on your calves. The tilting mechanism has 4 locking positions and returns automatically to the initial position.

More comfort

The addition of a seat cushion will make your North Cape chair even softer and can add an accent of colour.

Range

Executive

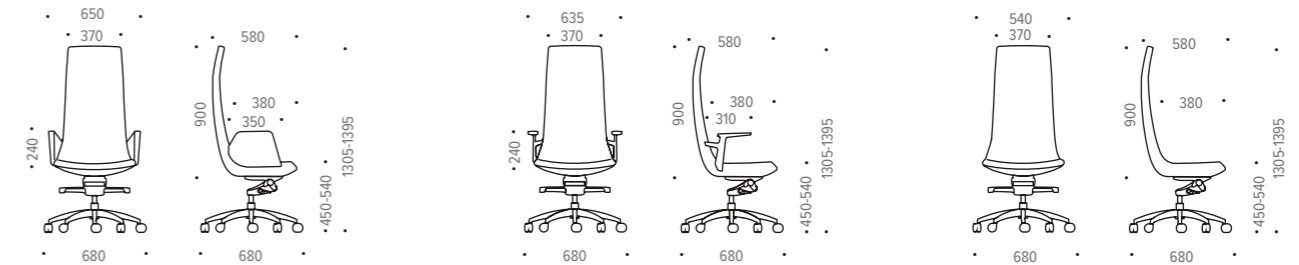

Executive Soft

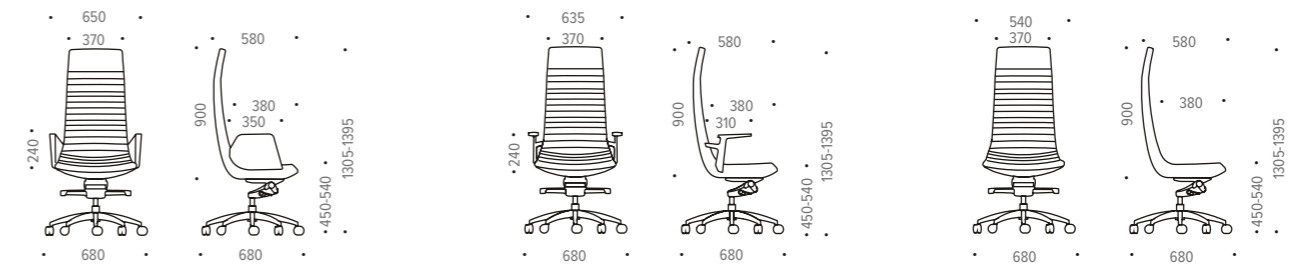

Task

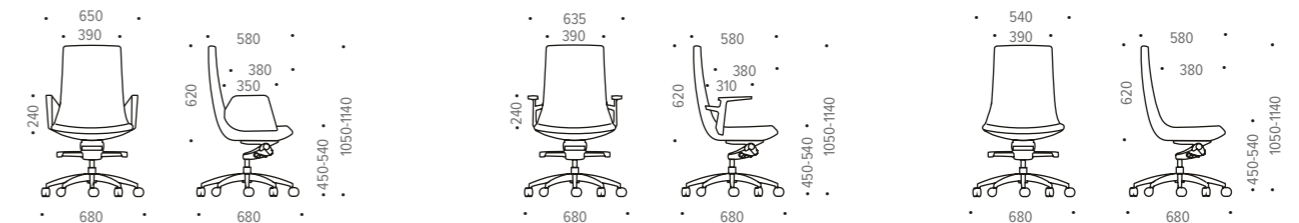

Meeting

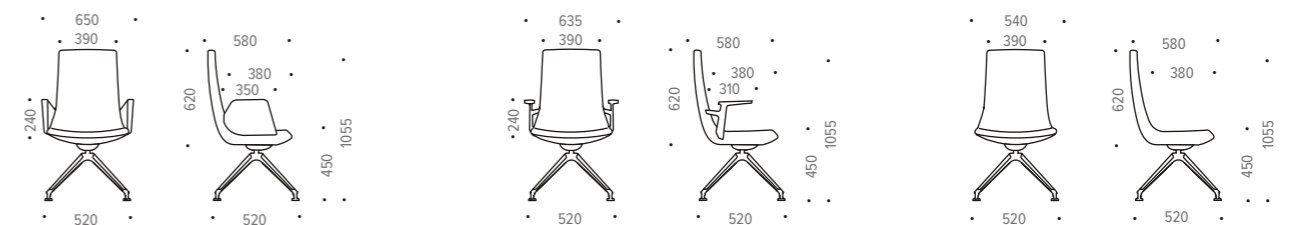

Visitor & conference

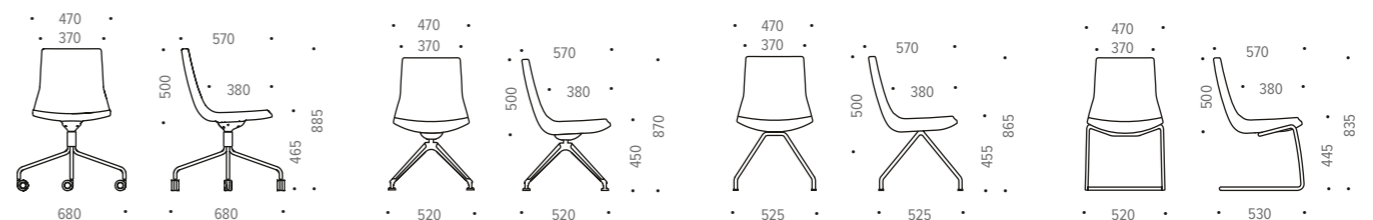

Armchairs

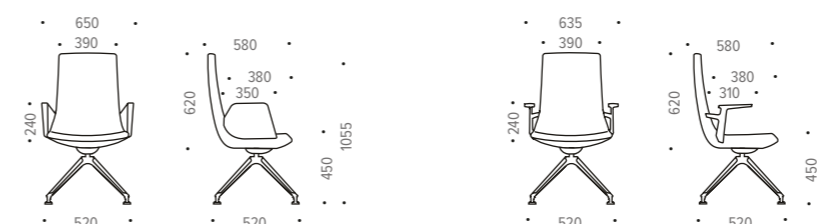

Technical

Seat and back

- Steel frame molded with polyurethane and glued with foam
- Upholstered with fabric or leather

Armrests

- Black PA armrests, soft PU upper pad, 310 x 240 x 110 mm
- Upholstered PU armrests, 350 x 240 x 90 mm

Mechanism

- Knee-tilt mechanism with side tension adjustment
- 4 locking backrest positions (executive and task chairs)
- Quick tension adjustment

Gas lift

- Chrome or black colour
- 90mm run range (executive and task chairs)

Bases

- 5-star polished aluminium or black plastic base with fibreglass, external Ø680mm (executive and task chairs)
- 4-leg base: top in polished aluminium, bottom - black or chrome steel frame base (visitor and meeting chairs)
- Cantilever chrome steel frame with plastic glides

Castors



- Ø65mm rubber freewheel castors for hard floor
- Ø65mm PA freewheel castors for soft floor

Accessories

- Seat cushion for executive, task and meeting chairs







Materials







Fabric*









- Berta
- Leather Look
- Step/Step Melange
- Camira Xtreme 
- Velito
- Camira Synergy
- Gabriel Cyber 
- Valencia C5
- Genuine Leather







 Eco friendly



G1: Berta	G2: Leather Look Step/Step Melange Xtreme	G3: Valencia C5 Synergy Velito	G4: Genuine Leather										
				CODE	DESCRIPTION	WIDTH	DEPTH	HEIGHT	SEAT	G1 (£)	G2 (£)	G3 (£)	G4 (£)
				SND020	Executive chair with black base	680	680	1255-1345	400-490	1,323	1,347	1,425	2,083
				SND220	Executive chair with polished aluminium base	680	680	1255-1345	400-490	1,449	1,478	1,544	2,221
				SND024	Executive chair with poliamyde armrests (black color, soft PU top), black base	680	680	1255-1345	400-490	1,529	1,552	1,619	2,294
				SND224	Executive chair with poliamyde armrests (black color, soft PU top), polished aluminium base	680	680	1255-1345	400-490	1,659	1,678	1,750	2,438
				SND023	Executive chair with upholstered armrests, black base	680	680	1255-1345	400-490	1,713	1,750	1,839	2,683
				SND223	Executive chair with upholstered armrests, polished aluminium base	680	680	1255-1345	400-490	1,845	1,882	1,964	2,826
				SNZ001	Seat cushion	530	430	-	-	75	81	104	170

G1: Berta		G2: Leather Look Step/Step Melange Xtreme		G3: Valencia C5 Cyber Synergy Velito		G4: Genuine Leather				
	CODE	DESCRIPTION	WIDTH	DEPTH	HEIGHT	SEAT	G1 (£)	G2 (£)	G3 (£)	G4 (£)
	SNC020	Task chair with black base	680	680	1000-1090	400-490	1,323	1,341	1,395	1,963
	SNC220	Task chair with polished aluminium base	680	680	1000-1090	400-490	1,455	1,473	1,532	2,108
	SNC024	Task chair with poliamyde armrests (black color; soft PU top), black base	680	680	1000-1090	400-490	1,462	1,480	1,540	2,115
	SNC224	Task chair with poliamyde armrests (black color; soft PU top), polished aluminium base	680	680	1000-1090	400-490	1,594	1,611	1,666	2,252
	SNC023	Task chair with upholstered armrests, black base	680	680	1000-1090	400-490	1,695	1,749	1,850	2,539
	SNC223	Task chair with upholstered armrests, polished aluminium base	680	680	1000-1090	400-490	1,819	1,874	1,975	2,675

	CODE	DESCRIPTION	WIDTH	DEPTH	HEIGHT	SEAT	G1 (£)	G2 (£)	G3 (£)	G4 (£)
	SNA010	Meeting chair	540	580	1055	450	1,437	1,449	1,503	2,071
	SNA014	Meeting chair with poliamyde armrests (black colour, soft PU top)	635	580	1055	450	1,574	1,586	1,651	2,232
	SNA013	Meeting chair with upholstered armrests	650	580	1055	450	1,894	1,907	1,924	2,685
	SNA400	Meeting chair with chrome 4-leg steel frame base	525	570	870	450	902	907	931	1,350
	SNA600	Meeting chair with chrome cantilever steel frame base	520	570	835	455	887	893	933	1,365
	SNA210	Meeting chair with 4-leg swivel base, polished aluminium top	520	570	870	450	1,180	1,199	1,245	1,724
	SNA700/P1	Meeting chair. Base: swivelling, pyramid type powder-coated wire steel with castors. Seat height not adjustable.	680	680	885	465	938	997	1,043	1,380
	SNA700/P2	Meeting chair. Base: swivelling, pyramid type powder-coated wire steel with hollow castors. Seat height not adjustable.	680	680	885	465	1,004	1,070	1,116	1,446

G1: Leather Look Step/Step Melange		G2: Synergy Velito		G3: Genuine Leather					
	CODE	DESCRIPTION	WIDTH	DEPTH	HEIGHT	SEAT	G1 (£)	G2 (£)	G3 (£)
	SNE020	Executive chair with black base	680	680	1255-1345	400-490	1,527	1,611	2,252
	SNE220	Executive chair with polished aluminium base	680	680	1255-1345	400-490	1,659	1,737	2,373
	SNE024	Executive chair with poliamyde armrests (black color, soft PU top), black base	680	680	1255-1345	400-490	1,695	1,785	2,441
	SNE224	Executive chair with poliamyde armrests (black color, soft PU top), polished aluminium base	680	680	1255-1345	400-490	1,819	1,904	2,604
	SNE023	Executive chair with upholstered armrests, black base	680	680	1255-1345	400-490	1,865	1,966	2,804
	SNE223	Executive chair with upholstered armrests, polished aluminium base	680	680	1255-1345	400-490	1,991	2,098	2,967

Moon

Meeting + Conference + Operator chairs + Stools



The simple but elegant Moon chair family make a positive addition to any workspace.

The comfortable task chair comes with a choice of 5-star polished aluminium or black plastic with fibreglass base.

Meeting chairs come with a choice of sled steel frame or 4 legs with or without an integrated armrest. All meeting chairs are suitable for a conference environment and can be easily stacked up to 5 chairs high.

The high chairs are ideal for raised breakout meeting tables or bars and are stackable up to 3 chairs high.

Range

Operator chair

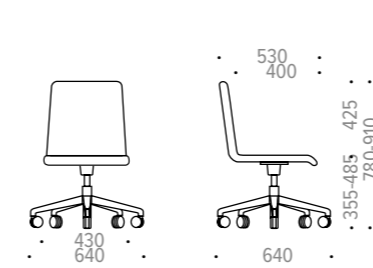

Stools

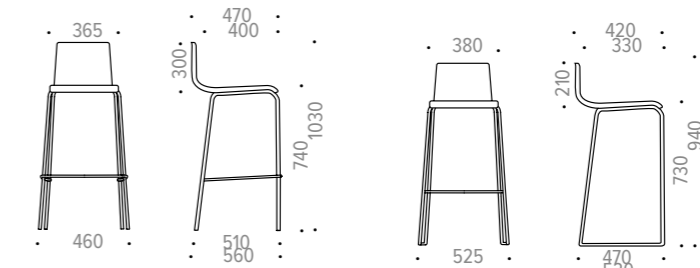

Meeting chairs

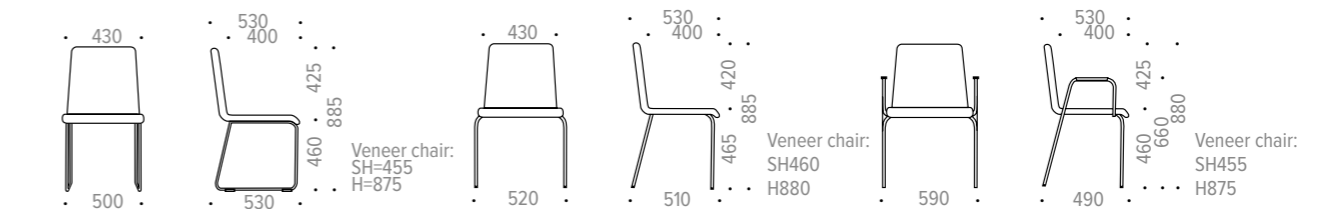

Technical

Types

- Task, meeting & conference and high chairs

Seat and back

- Frame made of plywood
- Foam made of cut foam (density H5050)
- Upholstered with fabric or leather
- Covered with natural wood veneer or laminated veneer

Mechanism

- Tilting mechanism lockable in working position
- Knob for tension adjustment

Gas lift

- Chrome or black colour
- 130mm run range
- Pneumatic regulation of the height

Bases

- 5-star polished aluminium or black plastic with fibreglass base
- External Ø640mm
- Chrome or powder-coated Ø11mm steel sled frame with soft floor or hard floor glides
- 4-leg Ø18mm chrome steel frame
- 4-leg Ø18mm chrome steel frame, integrated armrests with plastic finish
- 4-leg Ø16mm chrome steel frame

Castors

- Ø65mm rubber freewheel castors for hard floor
- Ø65mm PA freewheel castors for soft floor

Materials

G1 Fabric*

Berta
Camira Era
Bondai

G2 Fabric*

Leather Look
Step/Step melange
Camira Xtreme ♻️

G3 Fabric*

Gabriel Cyber ♻️
Velito
Camira Synergy

G4 Fabric

Genuine Leather

G1 Veneer

Beech (Z1)

G2 Veneer







Oak (Z2)
White Matt Beech Lam. (Z3)
Beech Stained Black (Z4)





Frames









Black (A)
White (E)
Grey (M)
Dark Grey (T1)
Chrome



♻️ Eco friendly

* Not every fabric from these ranges is available on standard Narbutas lead times - please see Fabrics section at back of price list for details

	CODE	DESCRIPTION	WIDTH	DEPTH	HEIGHT	SEAT	G1 (£)	G2 (£)	G3 (£)	G4 (£)
	SXC020	Task chair, upholstered, black plastic base	640	640	780-910	380-510	576	606	685	970
	SXC120	Task chair, upholstered, polished aluminium base	640	640	780-910	380-510	660	689	786	1,037
	SXA420	Stackable conference chair, upholstered, powder-coated wire steel frame, stack 5 units high	500	530	885	460	541	571	636	870
	SXA620	3 units per box	500	530	885	460	1,255	1,345	1,542	2,242
	SXA020	Stackable conference chair, upholstered, chrome-plated wire steel frame, stack 5 units high	500	530	885	460	559	595	690	952
	SXA220	3 units per box	500	530	885	460	1,309	1,417	1,703	2,493
	SXA030/P1	Visitor chair. Base: swivelling, pyramid type powder-coated wire steel with castors. Seat height not adjustable.	680	680	860	465	853	911	960	1,173
	SXA030/P2	Visitor chair. Base: swivelling, pyramid type powder-coated wire steel with hollow castors. Seat height not adjustable.	680	680	860	465	943	993	1,050	1,255
	SXA000	Stackable conference chair, upholstered, 4-leg chromed steel frame, stack 5 units high	520	530	885	465	571	606	690	966
	SXA300	3 units per box	520	530	885	465	1,318	1,426	1,678	2,504

	CODE	DESCRIPTION	WIDTH	DEPTH	HEIGHT	SEAT	G1 (£)	G2 (£)	G3 (£)	G4 (£)
	SXA004	Stackable conference chair, upholstered, 4-leg chromed steel frame with integrated armrests with plastic finish, stack 5 units high	590	530	880	460	690	714	798	1,037
	SXA204	3 units per box	590	530	880	460	1,652	1,724	1,975	2,695
	SXA010	Stackable conference chair, upholstered, 4-leg powder-coated steel frame, stack 5 units high	520	530	885	465	563	593	683	897
	SXA310	3 units per box	520	530	885	465	1,278	1,368	1,637	2,283
	SXA014	Stackable conference chair, upholstered, 4-leg powder-coated steel frame with integrated armrests with plastic finish, stack 5 units high	590	530	880	460	678	701	786	972
	SXA214	3 units per box	590	530	880	460	1,638	1,709	1,961	2,517
	SXA200	Stool, upholstered, 4-leg chromed steel frame	470	560	1030	770	642	654	696	864
	SXA210	Stool, upholstered, 4-leg powder-coated steel frame	470	560	1030	770	592	598	641	785

	CODE	DESCRIPTION	WIDTH	DEPTH	HEIGHT	SEAT	G1 (£)	G2 (£)
	SXA520	Stackable conference chair, plywood shell, powder-coated wire steel frame, stack 5 units high	490	530	875	455	517	559
	SXA720	3 units per box	490	530	875	455	1,135	1,261
	SXA120	Stackable conference chair, plywood shell, chrome-plated wire steel frame, stack 5 units high	490	530	875	455	528	571
	SXA320	3 units per box	490	530	875	455	1,170	1,296
	SXA100	Stackable conference chair, plywood shell, 4-leg chromed steel frame, stack 5 units high	520	530	880	460	533	575
	SXA400	3 units per box	520	530	880	460	1,210	1,336
	SXA104	Stackable conference chair, plywood shell, 4-leg chromed steel frame, integrated armrests with plastic finish, stack 5 units high	590	530	875	455	583	632
	SXA304	3 units per box	590	530	875	455	1,386	1,529
	SXA110	Stackable conference chair, plywood shell, 4-leg powder-coated steel frame, stack 5 units high	520	530	880	460	480	503
	SXA410	3 units per box	520	530	880	460	1,170	1,242
	SXA114	Stackable conference chair, plywood shell, 4-leg powder-coated steel frame, integrated armrests with plastic finish, stack 5 units high	590	530	875	455	564	595
	SXA314	3 units per box	590	530	875	455	1,332	1,421
	SXA600	Stackable stool, plywood shell, powder-coated wire steel frame, stack 3 units high	525	420	940	730	615	656
	SXA500	Stackable stool, plywood shell, chrome-plated wire steel frame, stack 3 units high	525	420	940	730	662	698

	CODE	DESCRIPTION	WIDTH	DEPTH	HEIGHT	RSP (£)
	ZUZ002	R/H folding table (available on chairs with armrests)	250	356	616	130
	ZXZ002	Linking gliders for SXA100 SXA104 SXA0 or SXA4				82



Gama

Conference / meeting chairs



Gama meeting chairs are the perfect choice for conference rooms with a stylish reclined design that provides maximum comfort.

Choose between a high or low backrest in fabric or mesh and a cantilever or 4-leg frame.

A large choice of fabrics are available for backrest and seat including genuine leather. Frames come in chrome or powder-coated steel.

Range

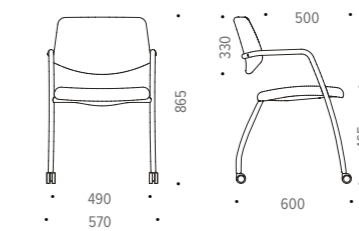
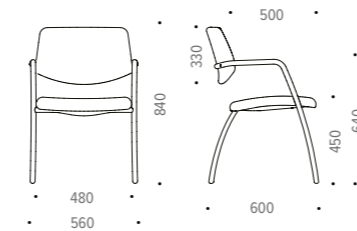
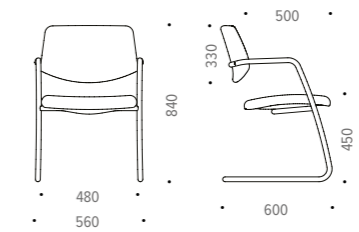
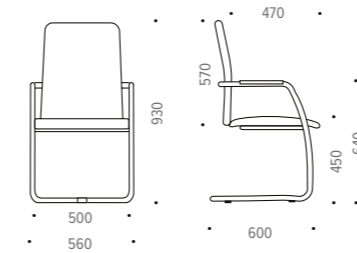

Technical

Seat

- Lower part made of PP (polypropylene)
- Foam made of cut foam (density H5050)
- Upholstered with fabric or leather

Back

- Frame made of black plastic
- Foam made of cut foam (density H5050) (fabric upholstery)
- Upholstered with fabric, leather or mesh

Armrests

- Integrated armrests with plastic pads

Bases

- 4-leg chromed or powder-coated steel frame with plastic glides, Ø25mm
- 4-leg chromed or powder-coated steel frame with castors, Ø25mm
- Cantilever chromed or powder-coated steel frame with plastic glides, Ø25mm

Castors

- Rubber free wheel castors for hard floor, Ø50mm
- PA (polyamide) free wheel castors for soft floor, Ø50mm

Materials

G1 Fabric*

Berta
Camira Era
Bondai

G2 Fabric*

Leather Look
Gabriel Step/Step Melange
Camira Xtreme 

G3 Fabric*

Gabriel Cyber 
Velito
Camira Synergy

G4 Fabric

Genuine Leather

GM Mesh

Black (GM8)
Light Grey (GM9)







PM Mesh





Black (PM1)
Grey (PM2)

Metal

Black (A)
Chrome (H)
Grey (M)

 Eco friendly

	CODE	DESCRIPTION	WIDTH	DEPTH	HEIGHT	SEAT	G1 (£)	G2 (£)	G3 (£)	G4 (£)
	SIA004	Stackable 4 leg meeting chair, steel frame can be chrome or powder-coated, stack 6 units high	560	600	840	450	581	604	628	758
	SIA204	2 units per box	560	600	840	450	817	863	910	1,169
	SIA024	Stackable cantilever meeting chair, steel frame can be chrome or powder-coated, integrated armrests with plastic finish, stack 6 units high	560	600	840	450	629	653	675	805
	SIA324	2 units per box	560	600	840	450	996	1,043	1,089	1,347
	SIA224	Stackable cantilever meeting chair, steel frame can be chrome or powder-coated, stack 6 units high	560	600	930	450	653	683	751	929
	SIA624	2 units per box	560	600	930	450	1,152	1,211	1,352	1,705
	SIA314	Meeting chair, 4 leg with castors, steel frame can be chrome or powder-coated	570	600	865	465	576	587	629	759

	CODE	DESCRIPTION	WIDTH	DEPTH	HEIGHT	SEAT	G1 (£)	G2 (£)	G3 (£)	G4 (£)
	SIA104	Stackable 4 leg meeting chair, seat upholstered with fabric, backrest with mesh, steel frame can be chrome or powder-coated, stack 6 units high	560	600	840	450	590	602	624	666
	SIA304	2 units per box	560	600	840	450	1,036	1,059	1,107	1,189
	SIA124	Stackable cantilever meeting chair, seat upholstered with fabric, backrest with mesh, steel frame can be chrome or powder-coated, stack 6 units high	560	600	840	450	590	602	624	666
	SIA424	2 units per box	560	600	840	450	1,032	1,055	1,101	1,184
	SIA414	Meeting chair, 4 leg with castors, seat upholstered with fabric, backrest with mesh, steel frame can be chrome or powder-coated	560	600	840	450	582	587	612	688

Wait

Conference chairs + Stools



The Wait chair's flexible and lightweight design make it a popular choice for conference seating.

With a choice of steel sled frame stackable up to 10 high, or steel legs with or without castors stackable up to 6 high the Wait chair can be adapted to suit any aesthetic. An optional trolley makes reworking room layouts or moving chairs from room to room quick and easy.

Wait comes in a choice of 7 plastic colours and multiple fabric options for the backrest and seat including Velito, Synergy and Leather Look.

Chairs with a 4 leg steel base offer an integrated armrest option with a small folding table accessory also available, making them ideal for training workshops or lectures.

The high chair option is ideal for breakout areas with high tables or dining areas with bars.

Range

Conference chairs

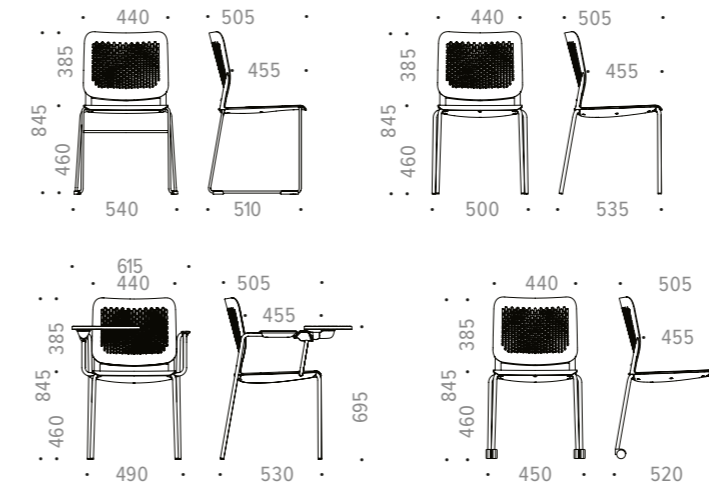

Stool

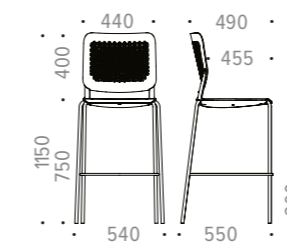

Trolley

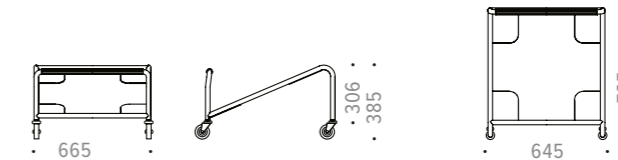

Technical

Seat and back

- Seat made of high quality plastic (PP - polypropylene), covered with foam (density H5050), upholstered with fabric or leather
- Back made of high quality plastic (PP)

Bases

- Ø11mm chrome-plated sled frame,
- Ø18mm four-leg chrome steel frame, Ø18mm
- Ø18mm four-leg chrome steel frame with Ø18mm integrated armrests on the frame with plastic finish (PP pad)
- Ø18mm four-leg chrome steel frame, with castors

Castors

- Ø50mm PA freewheel castors for soft floor (SUA10 only)

Trolley

- Capacity for 4-legs base frame chairs (10 pcs.)
- Capacity for sled base frame chairs (16 pcs.)

Materials

G1 Fabric*

Berta
Camira Era
Bondai

G2 Fabric*

Leather Look
Gabriel Step/Step melange
Camira Xtreme 









G3 Fabric*









Velito
Camira Synergy

Plastic

White (PC0)
Black (PC1)
Grey (PC2)
Green (PC3)
Blue (PC4)
Red (PC5)

 Eco friendly

	CODE	DESCRIPTION	WIDTH	DEPTH	HEIGHT	SEAT	G1 (£)	G2 (£)	G3 (£)
	SUA100	Stackable conference chair, upholstered seat, plastic backrests, chrome-plated four-leg steel frame, stack 6 units high	510	535	830	460	419	425	435
	SUA500	3 units per box	510	535	830	460	968	985	1,019
	SUA101	Stackable conference chair with armrests, upholstered seat, plastic backrests, chrome-plated four-leg steel frame, stack 6 units high	535	535	830	460	497	502	524
	SUA401	3 units per box	535	535	830	460	1,253	1,268	1,336
	SUA320	Stackable conference chair, upholstered seat, plastic backrests, chrome-plated wire steel frame, stack 10 units high	540	535	830	460	408	414	425
	SUA620	3 units per box	540	535	830	460	1,048	1,065	1,099
	SUA110	Conference chair, upholstered seat, plastic backrests, chrome-plated four-leg steel frame with castors	525	550	830	460	434	439	451
	SUA410	3 units per box	525	550	830	460	1,057	1,075	1,107
	SUA200	Stackable conference chair, upholstered seat and backrest, chrome-plated four-leg steel frame, stackable, stack 6 units high	510	535	830	460	448	464	504
	SUA900	3 units per box	510	535	830	460	1,161	1,211	1,329
	SUA201	Stackable conference chair with armrests, upholstered seat and backrest, chrome-plated four-leg steel frame, stack 6 units high	435	535	830	460	552	563	602
	SUA501	3 units per box	435	535	830	460	1,438	1,470	1,588
	SUA420	Stackable conference chair, upholstered seat and backrest, chrome-plated wire steel frame, stackable, stack 10 units high	540	535	830	460	429	446	484
	SUA720	3 units per box	540	535	830	460	1,069	1,118	1,236
	SUA210	Conference chair, upholstered seat and backrest, chrome-plated four-leg steel frame with castors	525	550	830	460	457	474	512
	SUA510	3 units per box	525	550	830	460	1,084	1,135	1,253

	CODE	DESCRIPTION	WIDTH	DEPTH	HEIGHT	SEAT	G1 (£)	G2 (£)	G3 (£)
	SUA400	Stackable stool, upholstered seat, plastic backrests, chrome-plated four-leg steel frame, stack 6 units high	540	550	1150	750	602	609	623
	CODE	DESCRIPTION	WIDTH	DEPTH	HEIGHT	SEAT	RSP (£)		
	SUA000	Stackable conference chair, plastic seat and backrests, chrome-plated four-leg steel frame, stack 6 units high	510	535	830	460	386		
	SUA800	3 units per box	510	535	830	460	886		
	SUA001	Stackable conference chair with armrests, plastic seat and backrests, chrome-plated four-leg steel frame, stack 6 units high	535	535	830	460	471		
	SUA301	3 units per box	535	535	830	460	1,168		
	SUA220	Stackable conference chair, plastic seat and backrests, chrome-plated wire steel frame, stack 10 units high	540	535	830	460	386		
	SUA520	3 units per box	540	535	830	460	886		
	SUA10	Conference chair, plastic seat and backrests, chrome-plated four-leg steel frame with castors	525	550	830	460	403		
	SUA310	3 units per box	525	550	830	460	934		
	SUA300	Stackable stool, plastic seat and backrest, chrome-plated four-leg steel frame, stack 6 units high	540	560	1150	750	576		
	ZUZ001	Trolley for transport and easy hanging of Wait chairs, fits 10 four-leg base chairs or 16 wire steel base frame chairs	645	715	405		598		
	ZUZ002	R/H folding table (available only on chairs with armrests)	250	356	616		130		
	ZUZ003	Gliders, which allows linkage of the chairs to lines (only for models with wire steel frame SUA220 SUA320 SUA420)					18		

Twist & Sit

Conference + Meeting + Lounge chairs + Stools

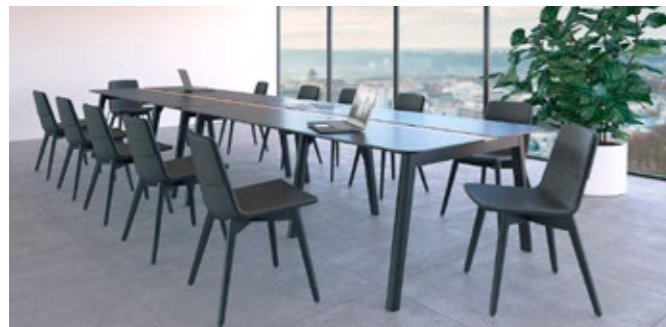

Distinctive character and freedom of expression for your individual style.

With its visually striking Scandinavian design, Twist & Sit soft seating family is perfect for modern offices that exude a chic vibe and looks just as great in traditional workspaces. It has expressive character, provides improvisational freedom and comes in different style variations. You can select almost 80 different colour combinations for the upholstered part of the chair, contrasting colours will bring a sense of exclusivity to your Twist & Sit furniture.

It also comes in a variety of base options so there is no need to compromise on style. Consider your functional needs as well as the fabric or design to accommodate your preferences.

Metal bases have a modern look and are practical, whereas wooden bases give the space a homely feel and add a touch of elegance to the room. Both base options are available in dark and light colours to further add to the beauty of contrast.



The high wraparound backrest diminishes surrounding noise and offers a pleasant sense of comfort and protection.

Our wide choice of Twist & Sit Lounge chairs will accommodate the needs of a broad array of office settings. The soft seating family includes meeting and conference chairs, lounge seating with high or low backrests as well as high chairs.

Twist & Sit lounge furniture is very versatile and suits not only usual office spaces but also special executive

spaces. It will add a special touch to both formal and informal meeting spaces, relaxation spots or creative areas. Mix and match different Twist & Sit models to create a desirable visual impact whether you want to convey a vibrant, edgy or playful feel or a subtle and calm one.

From airport lounges to office break rooms, from meeting rooms to co-working spaces, from bar counters to restaurant tables to living rooms, Twist & Sit is ideal for making any environment stand out.

Range

Visitor & conference

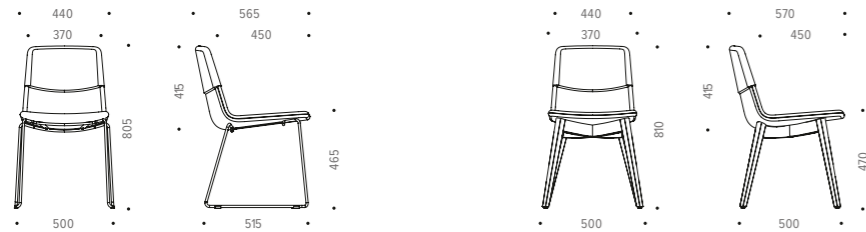

High

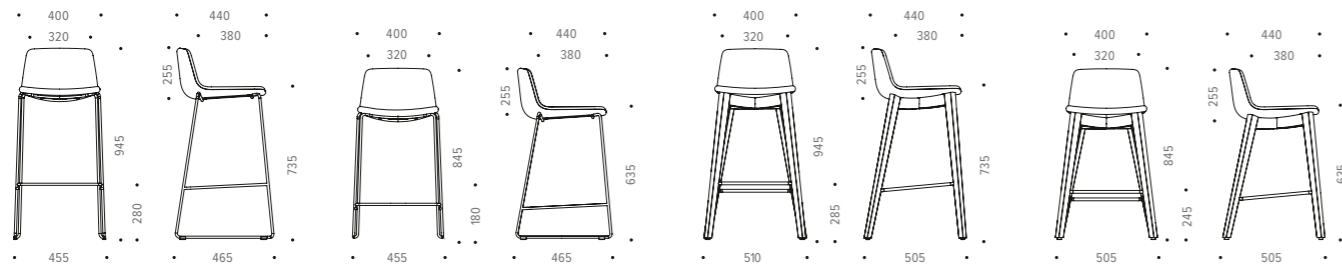

Lounge chairs

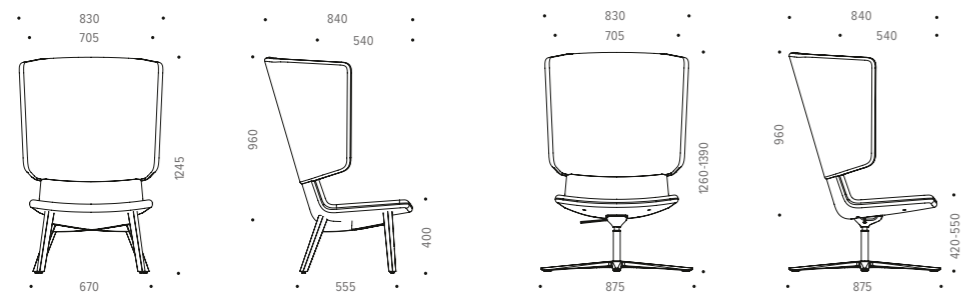

Armchairs

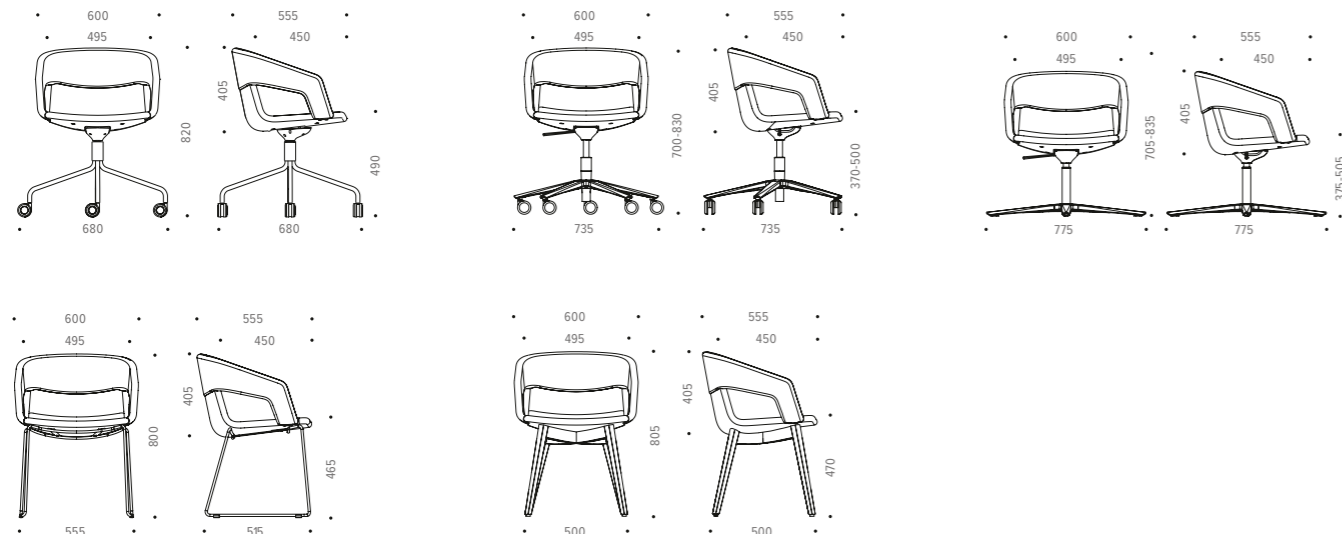

Technical

Seat and back

- Steel frame molded with polyurethane
- Upholstered with fabric or leather look

Armrests

- In one body with the backrest for visitor & conference chairs
- Steel frame molded with polyurethane
- Upholstered with same fabric or leather look as the backrest and seat

Mechanism

- Fixed mechanism
- Height adjustment with side lever
- Polished or finished in black colour

Gas lift

- Chromed or black colour
- 130 mm run range

Castors

- Rubber free wheel castors for hard floor, Ø65 mm
- PA (polyamide) free wheel castors for soft floor, Ø65 mm
- Rubber free wheel hollow castors for hard floor, Ø65 mm
- PA (polyamide) free wheel hollow castors for soft floor, Ø65 mm.

Bases

- Powder coated steel frame, Ø11 mm rod, plastic glides in black with or without felt for hard and soft floor (except lounge chairs)
- Wooden legs, lacquered and stained light grey or black ash solid wood, glued and fixed with metal fittings, felt or plastic pads for hard and soft floor, metal foot frame for high chairs
- Four-star base, polished or black painted aluminium, external Ø780 mm for armchairs and Ø880 mm for lounge chairs
- Five-star base, polished or black painted aluminium or black plastic with fiberglass, external Ø735 mm for visitor & conference chairs
- Pyramid (four-star) base from bend Ø20 mm steel rod, external Ø710 mm, powder coated

Materials

Fabric (P1/P3)

Berta
Camira Era
Gabriel Step/Step melange
Leather Look

Fabric (P2/P4)

Valencia C5
Gabriel Cyber 
Leather Look
Velito
Camira Synergy

Metal Legs

White (E)
Black (A)
Grey (M)
Dark Grey (T1)
Deep Bronze (S1)

Wooden Legs







Ash stained Light Grey (W2)
Ash stained Black (W3)









Swivel Base (SDA313)

White (E)
Black (A)
Grey (M)
Dusty Rose (ME1)
Avocado Green (ME2)







 Eco friendly









G1 INSIDE: Berta		G2 INSIDE: Era		G3 INSIDE: Step/Step Melange		G4 INSIDE: Era Step/Step Melange Leather Look					
G1 OUTSIDE: Berta		G2 OUTSIDE: Era		G3 OUTSIDE: Step/Step Melange		G4 OUTSIDE: Leather Look					
	CODE	DESCRIPTION	W	D	HEIGHT	SEAT	G1 (£)	G2 (£)	G3 (£)	G4 (£)	
	SDA020/P1	Conference chair. Steel framework. Entirely moulded in cold-cure polyurethane. Base: powder-coated wire steel frame on glides. Stackable (up to 5 chairs).	500	565	805	465	536	536	574	574	
	SDA120/P1	Set of conference chairs (3 pcs. per box). Steel framework. Entirely moulded in cold-cure polyurethane. Base: powder-coated wire steel frame on glides. Stackable (up to 5 chairs).	500	565	805	465	1,594	1,594	1,695	1,695	
	SDA040/P1	Conference chair. Steel framework. Entirely moulded in cold-cure polyurethane. Base: solid ash wood on glides.	500	570	810	470	763	763	813	813	
	SDA200/P1	High chair. For 1050 mm height desks. Steel framework. Entirely moulded in cold-cure polyurethane. Powder-coated wire steel frame. Stackable (up to 3 chairs).	455	465	945	735	593	593	618	618	
	SDA400/P1	Set of high chairs (3 pcs. per box). For 1050 mm height desks. Steel framework. Entirely moulded in cold-cure polyurethane. Powder-coated wire steel frame. Stackable (up to 3 chairs).	455	465	945	735	1,764	1,764	1,827	1,827	
	SDA300/P1	High chair. For 900 mm height desks. Steel framework. Entirely moulded in cold-cure polyurethane. Powder-coated wire steel frame. Stackable (up to 3 chairs).	455	465	845	635	580	580	605	605	
	SDA500/P1	Set of high chairs (3 pcs. per box). For 900 mm height desks. Steel framework. Entirely moulded in cold-cure polyurethane. Powder-coated wire steel frame. Stackable (up to 3 chairs).	455	465	845	635	1,714	1,714	1,796	1,796	

	CODE	DESCRIPTION	W	D	HEIGHT	SEAT	G1 (£)	G2 (£)	G3 (£)	G4 (£)
	SDA600/P1	High chair. For 1050 mm height desks. Steel framework. Entirely moulded in cold-cure polyurethane. Base: solid ash wood with painted metal footing and glides.	510	505	945	735	1,015	1,015	1,040	1,040
	SDA800/P1	High chair. For 900 mm height desks. Steel framework. Entirely moulded in cold-cure polyurethane. Base: solid ash wood with painted metal footing and glides.	505	505	845	635	996	996	1,027	1,027
	SDA023/P1	Armchair. Steel framework. Entirely moulded in cold-cure polyurethane. Base: powder-coated wire steel frame on glides.	600	555	800	465	882	882	952	952
	SDA043/P1	Armchair. Steel framework. Entirely moulded in cold-cure polyurethane. Base: solid ash wood on glides.	600	555	805	470	1,191	1,191	1,273	1,273
	SDA313/P1	Armchair. Steel framework. Entirely moulded in cold-cure polyurethane. Base: swivelling, pyramid type powder-coated wire steel with castors. The seat height is not adjustable.	680	680	820	490	1,109	1,109	1,210	1,210
	SDA313/P3	Armchair. Steel framework. Entirely moulded in cold-cure polyurethane. Base: swivelling, pyramid type powder-coated wire steel with castors. The seat height is not adjustable.	680	680	820	490	1,172	1,172	1,267	1,267
	SDA013/P1	Armchair. Steel framework. Entirely moulded in cold-cure polyurethane. Base: swivelling, height adjustable, 5-star die-cast polished aluminium with 65 mm castors.	735	735	700-830	370-500	1,191	1,191	1,273	1,273
	SDA113/P1	Armchair. Steel framework. Entirely moulded in cold-cure polyurethane. Base: swivelling, height adjustable, 5-star black powder-coated aluminium with 65 mm castors.	735	735	700-830	370-500	958	958	1,034	1,034

G1 INSIDE: Berta		G2 INSIDE: Era		G3 INSIDE: Step/Step Melange		G4 INSIDE: Era Step/Step Melange Leather Look		G4 OUTSIDE: Leather Look		
G1 OUTSIDE: Berta		G2 OUTSIDE: Era		G3 OUTSIDE: Step/Step Melange						
	CODE	DESCRIPTION	W	D	HEIGHT	SEAT	G1 (£)	G2 (£)	G3 (£)	G4 (£)
	SDA213/P1	Armchair. Steel framework. Entirely moulded in cold-cure polyurethane. Base: swivelling, height adjustable, 5-star black plastic with 65 mm castors.	735	735	700-830	370-500	895	895	958	958
	SDA033/P1	Armchair. Steel framework. Entirely moulded in cold-cure polyurethane. Swivel mechanism with height adjustment. 4-star base: polished die-cast aluminium on glides.	775	775	705-835	375-505	1,141	1,141	1,223	1,223
	SDA133/P1	Armchair. Steel framework. Entirely moulded in cold-cure polyurethane. Swivel mechanism with height adjustment. 4-star base: black powder-coated aluminium on glides.	775	775	705-835	375-505	945	945	1,002	1,002
	SDF030/P1	High back lounge chair. Steel framework. Entirely moulded in cold-cure polyurethane. Swivel mechanism with height adjustment. 4-star base: polished die-cast aluminium on glides.	875	875	1260-1390	420-550	1,872	1,872	2,035	2,035
	SDF130/P1	High back lounge chair. Steel framework. Entirely moulded in cold-cure polyurethane. Swivel mechanism with height adjustment. 4-star base: black powder-coated aluminium on glides.	875	875	1260-1390	420-550	1,632	1,632	1,790	1,790
	SDF040/P1	High back lounge chair. Steel framework. Entirely moulded in cold-cure polyurethane. Base: solid ash wood on glides.	830	840	1245	400	1,928	1,928	2,098	2,098

G1 INSIDE: Valencia C5		G2 INSIDE: Cyber		G3 INSIDE: Velito		G4 INSIDE: Synergy				
G1 OUTSIDE: Valencia C5		G2 OUTSIDE: Valencia C5 Leather Look Cyber		G3 OUTSIDE: Valencia C5 Leather Look Velito		G4 OUTSIDE: Valencia C5 Leather Look Synergy				
	CODE	DESCRIPTION	W	D	HEIGHT	SEAT	G1 (£)	G2 (£)	G3 (£)	G4 (£)
	SDA020/P2	Conference chair. Steel framework. Entirely moulded in cold-cure polyurethane. Base: powder-coated wire steel frame on glides. Stackable (up to 5 chairs).	500	565	805, SH=465	465	605	605	605	605
	SDA120/P2	Set of conference chairs (3 pcs. per box). Steel framework. Entirely moulded in cold-cure polyurethane. Base: powder-coated wire steel frame on glides. Stackable (up to 5 chairs).	500	565	805, SH=465	465	1,796	1,796	1,796	1,796
	SDA040/P2	Conference chair. Steel framework. Entirely moulded in cold-cure polyurethane. Base: solid ash wood on glides.	500	570	810, SH=470	470	857	857	857	857
	SDA200/P2	High chair. For 1050 mm height desks. Steel framework. Entirely moulded in cold-cure polyurethane. Powder-coated wire steel frame. Stackable (up to 3 chairs).	455	465	945, SH=735	735	662	662	662	662
	SDA400/P2	Set of high chairs (3 pcs. per box). For 1050 mm height desks. Steel framework. Entirely moulded in cold-cure polyurethane. Powder-coated wire steel frame. Stackable (up to 3 chairs).	455	465	945, SH=735	735	1,966	1,966	1,966	1,966
	SDA300/P2	High chair. For 900 mm height desks. Steel framework. Entirely moulded in cold-cure polyurethane. Powder-coated wire steel frame. Stackable (up to 3 chairs).	455	465	845, SH=635	635	643	643	643	643
	SDA500/P2	Set of high chairs (3 pcs. per box). For 900 mm height desks. Steel framework. Entirely moulded in cold-cure polyurethane. Powder-coated wire steel frame. Stackable (up to 3 chairs).	455	465	845, SH=635	635	1,916	1,916	1,916	1,916

G1 INSIDE: Valencia C5		G2 INSIDE: Cyber		G3 INSIDE: Velito		G4 INSIDE: Synergy					
G1 OUTSIDE: Valencia C5		G2 OUTSIDE: Valencia C5 Leather Look Cyber		G3 OUTSIDE: Valencia C5 Leather Look Velito		G4 OUTSIDE: Valencia C5 Leather Look Synergy					
	CODE	DESCRIPTION	W	D	HEIGHT	SEAT	G1 (£)	G2 (£)	G3 (£)	G4 (£)	
	SDA600/P2	High chair. For 1050 mm height desks. Steel framework. Entirely moulded in cold-cure polyurethane. Base: solid ash wood with painted metal footring and glides.	510	505	945	735	1,065	1,065	1,065	1,065	
	SDA800/P2	High chair. For 900 mm height desks. Steel framework. Entirely moulded in cold-cure polyurethane. Base: solid ash wood with painted metal footring and glides.	505	505	845	635	1,046	1,046	1,046	1,046	
	SDA023/P2	Armchair. Steel framework. Entirely moulded in cold-cure polyurethane. Base: powder-coated wire steel frame on glides.	600	555	800	465	1,046	1,046	1,046	1,046	
	SDA043/P2	Armchair. Steel framework. Entirely moulded in cold-cure polyurethane. Base: solid ash wood on glides.	600	555	805	470	1,361	1,361	1,361	1,361	
	SDA313/P2	Armchair. Steel framework. Entirely moulded in cold-cure polyurethane. Base: swivelling, pyramid type powder-coated wire steel with castors. The seat height is not adjustable.	680	680	820	490	1,305	1,305	1,305	1,305	
	SDA313/P4	Armchair. Steel framework. Entirely moulded in cold-cure polyurethane. Base: swivelling, pyramid type powder-coated wire steel with castors. The seat height is not adjustable.	680	680	820	490	1,361	1,361	1,361	1,361	

	CODE	DESCRIPTION	W	D	HEIGHT	SEAT	G1 (£)	G2 (£)	G3 (£)	G4 (£)
	SDA013/P2	Armchair. Steel framework. Entirely moulded in cold-cure polyurethane. Base: swivelling, height adjustable, 5-star die-cast polished aluminium with 65 mm castors.	735	735	700-830	370-500	1,361	1,361	1,361	1,361
	SDA113/P2	Armchair. Steel framework. Entirely moulded in cold-cure polyurethane. Base: swivelling, height adjustable, 5-star black powder-coated aluminium with 65 mm castors.	735	735	700-830	370-500	1,134	1,134	1,134	1,134
	SDA213/P2	Armchair. Steel framework. Entirely moulded in cold-cure polyurethane. Base: swivelling, height adjustable, 5-star black plastic with 65 mm castors.	735	735	700-830	370-500	1,059	1,059	1,059	1,059
	SDA033/P2	Armchair. Steel framework. Entirely moulded in cold-cure polyurethane. Swivel mechanism with height adjustment. 4-star base: polished die-cast aluminium on glides.	775	775	705-835	375-505	1,317	1,317	1,317	1,317
	SDA133/P2	Armchair. Steel framework. Entirely moulded in cold-cure polyurethane. Swivel mechanism with height adjustment. 4-star base: black powder-coated aluminium on glides.	775	775	705-835	375-505	1,097	1,097	1,097	1,097
	SDF030/P2	High back lounge chair. Steel framework. Entirely moulded in cold-cure polyurethane. Swivel mechanism with height adjustment. 4-star base: polished die-cast aluminium on glides.	875	875	1260-1390	420-550	2,256	2,256	2,256	2,256
	SDF130/P2	High back lounge chair. Steel framework. Entirely moulded in cold-cure polyurethane. Swivel mechanism with height adjustment. 4-star base: black powder-coated aluminium on glides.	875	875	1260-1390	420-550	2,016	2,016	2,016	2,016
	SDF040/P2	High back lounge chair. Steel framework. Entirely moulded in cold-cure polyurethane. Base: solid ash wood on glides.	830	840	1245	400	2,319	2,319	2,319	2,319

Twist & Sit Soft

Lounge chairs + Sofas



Twist & Sit Soft lounge seaters will help you add a homely feel to your office spaces and create a relaxing atmosphere. Available in different sizes and high-back or low-back versions the chairs allow you to transition smoothly from individual tasks to team meetings or chatting with colleagues.

Thanks to the recurrent design motives, the lounge chairs, armchairs and sofas fit together perfectly with the rest of the Twist & Sit range, help to create a uniform style and ensure a broader range of potential uses.

Well-rounded shapes and a distinctive connection between the lower and upper parts of the backrest create an expressive and instantly recognisable look. The immaculate appearance is achieved with stitching details extending smoothly throughout the surface of the seater from top to bottom.

Twist & Sit Soft seaters ensure a comfortable sitting experience thanks to the increased thickness of the PU padding. Besides highlighting the visually distinctive design of the seater, the design elements of the backrest also serve an important function as the

recessed lower part of the backrest subtly conforms to the natural contours of the spine, making the user feel comfortable. The side openings facilitate movement of air and come in handy when moving the seater from one place to another. A high-back seater will help you ensure a greater level of privacy serving as a barrier from background noise.

With its special stitching pattern and a wide range of fabric and leather look options, Twist & Sit Soft will enable you to choose the best single-colour or two-tone seaters for your office interior.

The lacquered solid ash wood is ideal for those who appreciate an authentic look, whereas the lacquered black stained option is perfect for those who opt for a unique style. Both options are easily compatible with different seater bases.

High-back seaters may come with optional accessories which can serve as additional statement pieces. The round wooden knob can be used for convenient hanging of personal items. The left-handed or right-handed swivel table provides a convenient surface for placing a laptop, a cup of coffee or a book.

Range

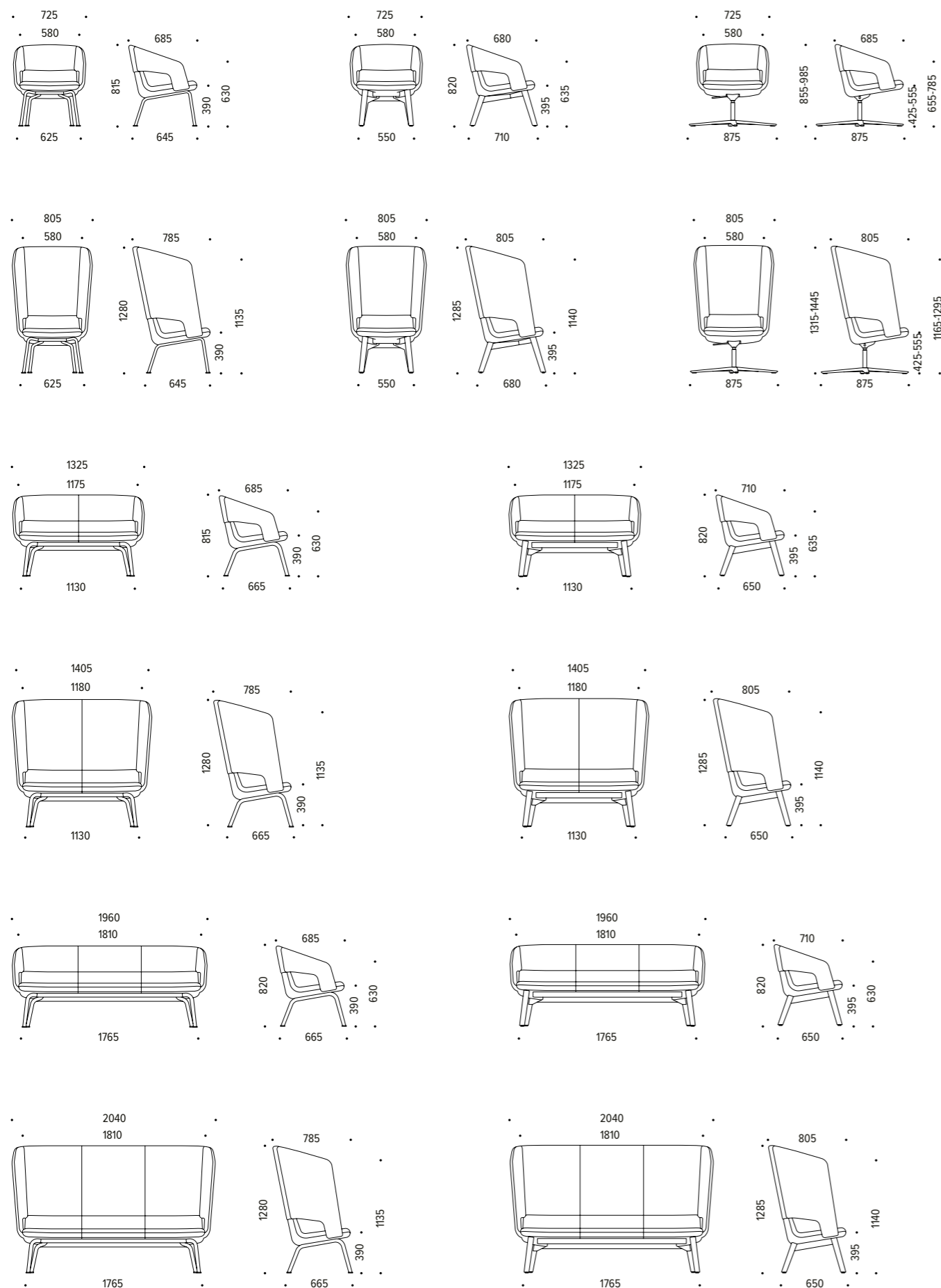

Technical

Seat and back

- Steel frame moulded with polyurethane
- Possible in low-back or high-back versions and three sizes – one-seater, two-seater and three-seater
- Upholstered with fabric or leather look, available in two colours (outside and inside)

Armrests

- In one body with the backrest, connected to the seat with steel plates
- Steel frame molded with polyurethane
- Upholstered with same fabric or leather look as the backrest and seat

Mechanism

- Fixed mechanism
- Height adjustment with side lever
- Polished or finished in black colour
- Only for one-seater version

Gas lift

- Chromed or finished in black colour
- 130mm run range
- Only for one-seater version

One-seater bases

- Powder coated steel legs from Ø25mm pipe, plastic glides in black, with/without felt for hard and soft floor
- Wooden legs, lacquered natural or lacquered and stained black ash solid wood, glued and fixed with metal fittings, plastic glides* in black, double sided, with or without felt for hard and soft floor
- 4-star base, polished or black painted aluminium, external Ø880mm

Two-seater and three-seater bases

- Powder coated steel legs from Ø32mm pipe, plastic glides in black, with or without felt for hard and soft floor
- Wooden legs, lacquered natural or lacquered and stained black ash solid wood, glued and fixed with metal fittings, plastic glides in black, with or without felt for hard and soft floor

Two-seater and three-seater bases frames

- Frame for metal legs: made from rectangular pipes 40 x 20 mm, assembled under seat and legs connected with metal fittings
- Frame for wooden legs: made from rectangular pipes 50 x 25 mm, assembled under seat and legs connected with metal fittings. Frame is covered with lacquered natural or lacquered and stained black solid ash-wood covers

Wooden knob

- Mounting place for accessories
- Made from lacquered natural or lacquered and stained black ash solid wood with metal fittings
- Mounted 1060mm from the ground
- Suitable only for high-back lounge chairs and sofas
- Accessories cannot be fitted on furniture that was not prepared for mounting

Swivel plywood table

- Table can be ordered L/H or R/H
- Made from 15mm plywood covered in wood veneer and lacquered edges
- Swivel mechanism made from 3D printed PP plastic and metal black powder coated parts
- Mounting bracket made from 3mm metal sheet, black powder coated and fixed with bolts covered with black plastic (PE) caps
- Mounted 665mm from the ground

- Suitable only for high-back lounge chairs and sofas
- Accessories cannot be fitted on furniture that was not prepared for mounting

*For one-seater with wooden legs glides are two sided and can be mounted and dismantled with screwdriver depending on the floor type – one side is for soft and other side is for hard floor

Materials

Fabric (P1)

Berta
Camira Era
Gabriel Step/Step melange
Leather Look

Fabric (P2)

Valencia C5
Gabriel Cyber 
Leather Look
Velito
Camira Synergy







Metal Legs









White (E)
Black (A)
Grey (M)
Dark Grey (T1)
Deep Bronze (S1)







Wooden Legs









Ash stained Light Grey (W2)
Ash stained Black (W3)



 Eco friendly

G1 INSIDE: Berta		G2 INSIDE: Era		G3 INSIDE: Step/Step Melange		G4 INSIDE: Era Step/Step Melange Leather Look					
G1 OUTSIDE: Berta		G2 OUTSIDE: Era		G3 OUTSIDE: Step/Step Melange		G4 OUTSIDE: Leather Look					
	CODE	DESCRIPTION	W	D	SEAT	HEIGHT	G1 (£)	G2 (£)	G3 (£)	G4 (£)	
	SDL100/P1	1-seater low back lounge chair, steel framework, base: powder-coated wire steel frame on glides	725	685	390	815	1,654	1,654	1,769	1,769	
	SDL200/P1	2-seater low back sofa, steel framework, base: powder-coated wire steel frame on glides	1325	685	390	815	3,270	3,270	3,514	3,514	
	SDL300/P1	3-seater low back sofa, steel framework, base: powder-coated wire steel frame on glides	1960	685	390	815	4,453	4,453	4,771	4,771	
	SDH100/P1	1-seater high back lounge chair, steel framework, base: powder-coated wire steel frame on glides	805	785	390	1280	2,514	2,514	2,752	2,752	
	SDH200/P1	2-seater high back sofa, steel framework, base: powder-coated wire steel frame on glides	1405	785	390	1280	4,331	4,331	4,765	4,765	
	SDH300/P1	3-seater high back sofa, steel framework, base: powder-coated wire steel frame on glides	2040	785	390	1280	7,119	7,119	7,839	7,839	
	SDL030/P1	1-seater low back lounge chair, steel framework, swivel mechanism with height adjustment, 4-star base: polished die-cast aluminium on glides	875	875	425-555	855-985	1,824	1,824	1,946	1,946	

	CODE	DESCRIPTION	W	D	SEAT	HEIGHT	G1 (£)	G2 (£)	G3 (£)	G4 (£)
	SDL130/P1	1-seater low back lounge chair, steel framework, swivel mechanism with height adjustment, 4-star base: black powder-coated aluminium on glides	875	875	425-555	855-985	1,727	1,727	1,837	1,837
	SDH030/P1	1-seater high back lounge chair, steel framework, swivel mechanism with height adjustment, 4-star base: polished die-cast aluminium on glides	875	875	425-555	1315-1445	2,575	2,575	2,794	2,794
	SDH130/P1	1-seater high back lounge chair, steel framework, swivel mechanism with height adjustment, 4-star base: black powder-coated aluminium on glides	875	875	425-555	1315-1445	2,465	2,465	2,691	2,691
	SDL101/P1	1-seater low back lounge chair, steel framework, base: solid ash wood on glides	725	710	395	820	2,123	2,123	2,239	2,239
	SDL201/P1	2-seater low back sofa, steel framework, base: solid ash wood on glides	1325	710	395	820	3,825	3,825	4,051	4,051
	SDL301/P1	3-seater low back sofa, steel framework, base: solid ash wood on glides	1960	710	395	820	4,996	4,996	5,307	5,307
	SDH101/P1	1-seater high back lounge chair, steel framework, base: solid ash wood on glides	805	805	395	1285	2,880	2,880	3,105	3,105
	SDH201/P1	2-seater high back sofa, steel framework, base: solid ash wood on glides	1405	805	395	1285	5,082	5,082	5,509	5,509
	SDH301/P1	3-seater high back sofa, steel framework, base: solid ash wood on glides	2040	805	395	1285	8,120	8,120	8,845	8,845

G1 INSIDE: Valencia C5		G2 INSIDE: Cyber		G3 INSIDE: Velito		G4 INSIDE: Synergy					
G1 OUTSIDE: Valencia C5		G2 OUTSIDE: Valencia C5 Leather Look Cyber		G3 OUTSIDE: Valencia C5 Leather Look Velito		G4 OUTSIDE: Valencia C5 Leather Look Synergy					
	CODE	DESCRIPTION	W	D	SEAT	HEIGHT	G1 (£)	G2 (£)	G3 (£)	G4 (£)	
	SDL100/P2	1-seater low back lounge chair, steel framework, base: powder-coated wire steel frame on glides	725	685	390	815	1,861	1,861	1,861	1,861	
	SDL200/P2	2-seater low back sofa, steel framework, base: powder-coated wire steel frame on glides	1325	685	390	815	3,715	3,715	3,715	3,715	
	SDL300/P2	3-seater low back sofa, steel framework, base: powder-coated wire steel frame on glides	1960	685	390	815	5,039	5,039	5,039	5,039	
	SDH100/P2	1-seater high back lounge chair, steel framework, base: powder-coated wire steel frame on glides	805	785	390	1280	2,959	2,959	2,959	2,959	
	SDH200/P2	2-seater high back sofa, steel framework, base: powder-coated wire steel frame on glides	1405	785	390	1280	5,131	5,131	5,131	5,131	
	SDH300/P2	3-seater high back sofa, steel framework, base: powder-coated wire steel frame on glides	2040	785	390	1280	8,437	8,437	8,437	8,437	
	SDL030/P2	1-seater low back lounge chair, steel framework, swivel mechanism with height adjustment, 4-star base: polished die-cast aluminium on glides	875	875	425-555	855-985	2,038	2,038	2,038	2,038	

	CODE	DESCRIPTION	W	D	SEAT	HEIGHT	G1 (£)	G2 (£)	G3 (£)	G4 (£)
	SDL130/P2	1-seater low back lounge chair, steel framework, swivel mechanism with height adjustment, 4-star base: black powder-coated aluminium on glides	875	875	425-555	855-985	1,940	1,940	1,940	1,940
	SDH030/P2	1-seater high back lounge chair, steel framework, swivel mechanism with height adjustment, 4-star base: polished die-cast aluminium on glides	875	875	425-555	1315-1445	2,989	2,989	2,989	2,989
	SDH130/P2	1-seater high back lounge chair, steel framework, swivel mechanism with height adjustment, 4-star base: black powder-coated aluminium on glides	875	875	425-555	1315-1445	2,886	2,886	2,886	2,886
	SDL101/P2	1-seater low back lounge chair, steel framework, base: solid ash wood on glides	725	710	395	820	2,337	2,337	2,337	2,337
	SDL201/P2	2-seater low back sofa, steel framework, base: solid ash wood on glides	1325	710	395	820	4,234	4,234	4,234	4,234
	SDL301/P2	3-seater low back sofa, steel framework, base: solid ash wood on glides	1960	710	395	820	5,558	5,558	5,558	5,558
	SDH101/P2	1-seater high back lounge chair, steel framework, base: solid ash wood on glides	805	805	395	1285	3,301	3,301	3,301	3,301
	SDH201/P2	2-seater high back sofa, steel framework, base: solid ash wood on glides	1405	805	395	1285	5,869	5,869	5,869	5,869
	SDH301/P2	3-seater high back sofa, steel framework, base: solid ash wood on glides	2040	805	395	1285	9,449	9,449	9,449	9,449

	CODE	DESCRIPTION	WIDTH	DEPTH	HEIGHT	RSP (£)
	SDZ001	Wooden knob (for R/H or L/H side)	Ø70	Ø70	-	98
	SDZ002	Swivel plywood table (R/H) with painted metal housing. Tabletop height - 665 mm from the ground	295	365	128	598
	SDZ003	Swivel plywood table (L/H) with painted metal housing. Tabletop height - 665 mm from the ground	295	365	128	598

Tula

Lounge chairs



Tula's distinct rounded seat shape creates a comfortable and inviting range of lounge seating. The two tone design means you can mix and match outer shell and seat fabrics to create vibrant seating areas in your workplace.

Choose from 4 base options to suit your requirements including swivel base with or without castors and solid wood legs.

A wide range of fabric colours and finishes are available including Leather Look.

Range

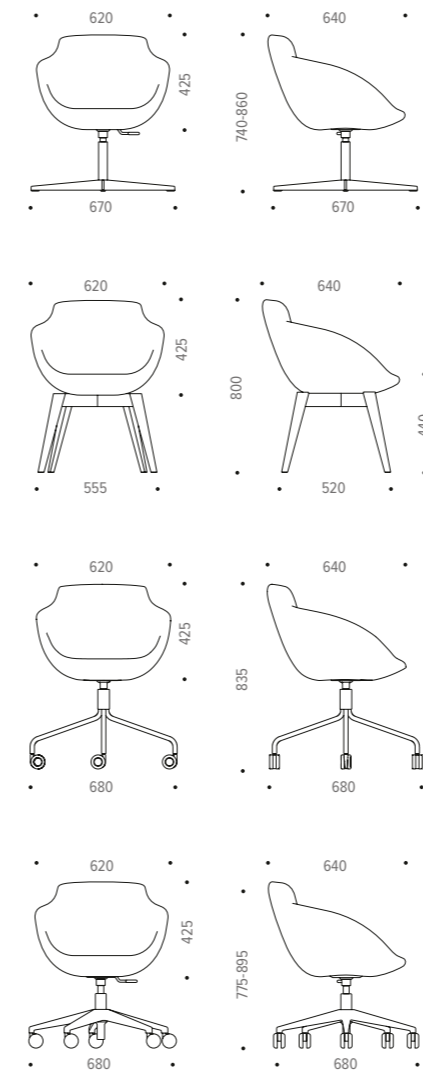

Materials

Fabric (P1)

Berta
Camira Era
Gabriel Step/Step Melange
Leather Look

Fabric (P2)

Camira Era
Gabriel Cyber 
Gabriel Step/Step Melange
Velito
Camira Synergy

Metal

Black (A)
White (E)
Grey (M)
Deep Bronze (S1)
Dark Grey (T1)

Pyramid base

Black (A)
White (E)
Grey (M)
Dusty Rose (ME1)
Avocado Green (ME2)

Wooden legs

Stained Nat. Ash (W2)
Ash stained Black (W3)

4-star / 5-star base

Aluminium

 Eco friendly

Technical

Frame and padding





- Steel framework molded in polyurethane;
- Round plywood plate Ø240mm, 12mm thickness on the bottom of shell.





Base options

- Four-star aluminium base with 120mm run range gas lift
- Five-star aluminium base with 65mm castors (for soft or hard floor), 120mm run range gas lift
- Four-leg lacquered and stained light grey or black ash solid wood base
- Pyramid (four-star) base from bend Ø20mm steel rod, external Ø680mm, powder coated

Castors:

- Rubber free wheel castors for hard floor, Ø65mm
- PA (polyamide) free wheel castors for soft floor, Ø65mm
- Rubber free wheel hollow castors for hard floor, Ø65mm
- PA (polyamide) free wheel hollow castors for soft floor, Ø65mm

G1 INSIDE: Berta		G2 INSIDE: Era		G3 INSIDE: Step/Step Melange		G4 INSIDE: Era Step/Step Melange Leather Look					
G1 OUTSIDE: Berta		G2 OUTSIDE: Era Step/Step Melange		G3 OUTSIDE: Era Step/Step Melange		G4 OUTSIDE: Leather Look					
	CODE	DESCRIPTION	WIDTH	DEPTH	HEIGHT	SEAT	G1 (£)	G2 (£)	G3 (£)	G4 (£)	
	SPA028/P1	Armchair. Steel framework. Entirely moulded in cold-cure polyurethane. Base: swivelling, pyramid type powder-coated wire steel with solid castors. Seat height not adjustable.	680	680	835	500	996	996	1,008	1,008	
	SPA028/P3	Armchair. Steel framework. Entirely moulded in cold-cure polyurethane. Base: swivelling, pyramid type powder-coated wire steel with hollow castors. Seat height not adjustable.	680	680	835	500	1,056	1,056	1,068	1,068	
	SPA026/P1	Armchair. Entirely moulded in cold-cure polyurethane. Steel framework. Base: swivelling, height adjustable, 5 star die-cast polished aluminium with castors.	680	680	775 - 895	435 - 555	972	972	1,002	1,002	
	SPA025/P1	Armchair. Entirely moulded in cold-cure polyurethane. Steel framework. Base: swivelling, height adjustable, polished aluminium.	670	670	740 - 860	405 - 525	990	990	990	990	
	SPA027/P1	Armchair. Entirely moulded in cold-cure polyurethane. Steel framework. Base: ash solid wood.	620	640	800	440	1,068	1,068	1,080	1,080	

G1 INSIDE: Era Step/Step Melange		G2 INSIDE: Cyber Velito Synergy		G3 INSIDE: Cyber Velito Synergy							
G1 OUTSIDE: Velito Synergy		G2 OUTSIDE: Era Step/Step Melange		G3 OUTSIDE: Cyber Velito Synergy Leather Look							
	CODE	DESCRIPTION	WIDTH	DEPTH	HEIGHT	SEAT	G1 (£)	G2 (£)	G3 (£)		
	SPA028/P2	Armchair. Steel framework. Entirely moulded in cold-cure polyurethane. Base: swivelling, pyramid type powder-coated wire steel with solid castors. Seat height not adjustable.	680	680	835	500	1,068	1,068	1,122		
	SPA028/P4	Armchair. Steel framework. Entirely moulded in cold-cure polyurethane. Base: swivelling, pyramid type powder-coated wire steel with hollow castors. Seat height not adjustable.	680	680	835	500	1,122	1,122	1,188		
	SPA026/P2	Armchair. Entirely moulded in cold-cure polyurethane. Steel framework. Base: swivelling, height adjustable, 5 star die-cast polished aluminium with castors.	680	680	775 - 895	435 - 555	1,044	1,044	1,086		
	SPA025/P2	Armchair. Entirely moulded in cold-cure polyurethane. Steel framework. Base: swivelling, height adjustable, polished aluminium.	670	670	740 - 860	405 - 525	1,020	1,020	1,068		
	SPA027/P2	Armchair. Entirely moulded in cold-cure polyurethane. Steel framework. Base: ash solid wood.	620	640	800	440	1,122	1,122	1,170		

Meg

Lounge chairs



Meg offers a simple and stylish lounge chair shape to complement most workplace design styles.

Choose from 4 base options to suit your requirements including swivel base with or without castors and steel or solid wood legs.

A wide range of fabric colours and finishes are available including genuine Leather.

Chair range

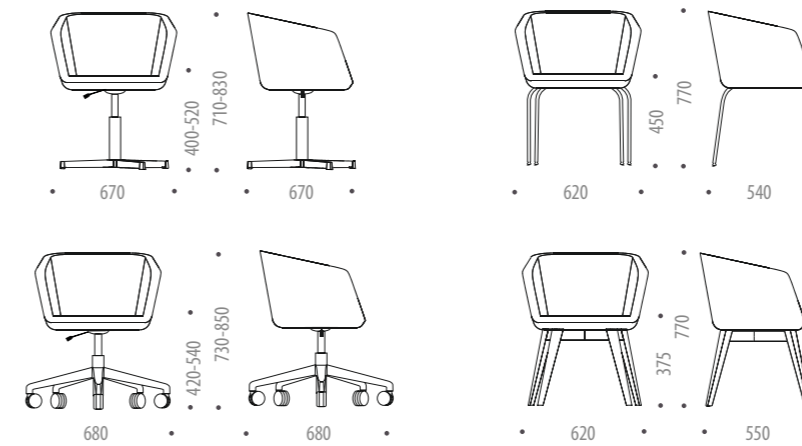

Materials

- G1 Fabric***
Camira Era
 - G2 Fabric***
Leather Look
Gabriel Step/Step Melange
Camira Xtreme
 - G3 Fabric***
Velito
Camira Synergy
 - G4 Fabric**
Genuine Leather
- Eco friendly

Technical

Frame and padding

- Moulded PU with steel sub frame
- The armchair body is cut between the seat and backrest
- Fabric is glued and fixed from the underside

Base

- 4–star aluminium base with 120mm range gas lift
- 4-leg chromed tube frame Ø20mm
- 5-star aluminium base with 65mm castors (for soft or hard floor), 120mm range gas lift
- 4-leg lacquered natural ash solid wood base

	CODE	DESCRIPTION	WIDTH	DEPTH	HEIGHT	SEAT	G1 (£)	G2 (£)	G3 (£)	G4 (£)
	SPA011	Height adjustable armchair, polished aluminium swivel base with castors	680	680	730-850	420-540	1,105	1,187	1,276	1,748
	SPA008	Armchair, chrome stainless steel legs	620	540	770	450	1,020	1,077	1,158	1,638
	SPA010	Height adjustable armchair, polished aluminium swivel base	670	670	710-830	400-520	1,063	1,114	1,203	1,675
	SPA009	Armchair, stained natural ash (W2) or ash stained black (W3) solid wood base	620	540	770	450	1,115	1,128	1,209	1,695

* Not every fabric from these ranges is available on standard Narbutas lead times - please see fabrics section at back of price list for details

Luna

Lounge chairs

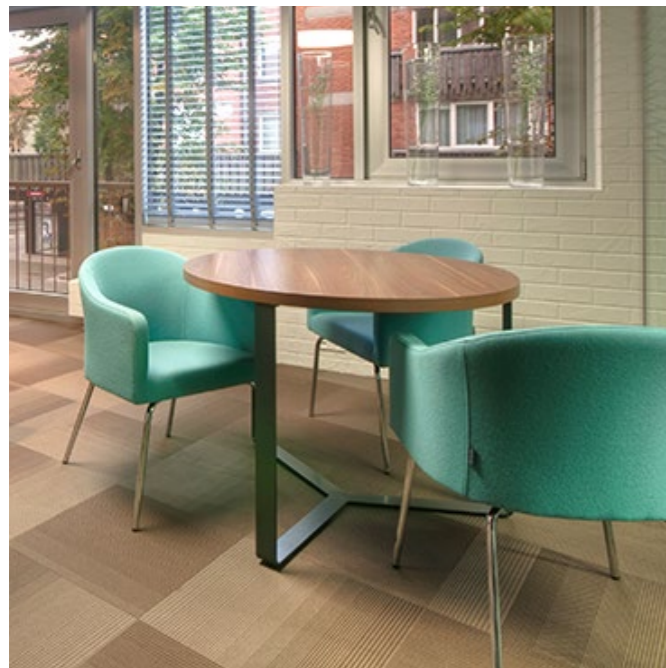

Luna is an elegantly simple lounge chair with armrests integrated into the backrest in a gentle curve. This comfortable design with a modest recline is ideal for breakout spaces or dining areas.

Choose from 3 base options to suit your requirements including aluminium swivel base with or without castors and stainless steel legs.

A wide range of fabric colours and finishes are available including genuine Leather.

Range

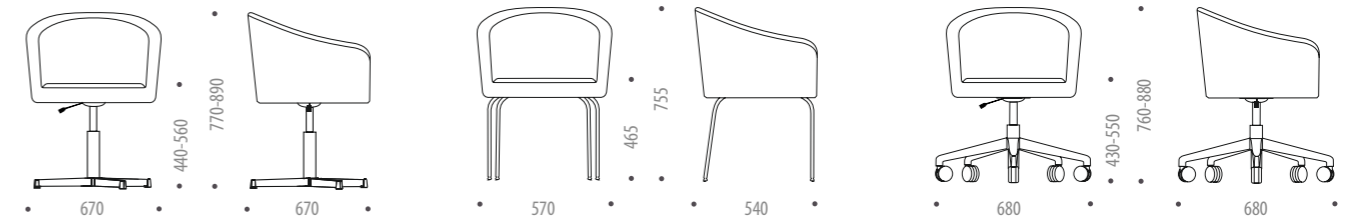

Technical

Frame and padding

- Moulded PU with steel sub frame
- The armchair is cut between the seat and the back to pull and fix the fabric from the underside

Base

- 4-star aluminium base with 120mm run range gas lift
- 4-leg chromed tube frame, Ø20mm
- 5-star aluminium base with Ø65mm castors (for soft or hard floor), 120mm run range gas lift

Materials

G1 Fabric*

Camira Era

G2 Fabric*

Leather Look
Gabriel Step/Step Melange
Camira Xtreme 



G3 Fabric*

Velito
Camira Synergy

G4 Fabric

Genuine Leather

 Eco friendly

	CODE	DESCRIPTION	WIDTH	DEPTH	HEIGHT	SEAT	G1 (£)	G2 (£)	G3 (£)	G4 (£)
	SPA014	Height adjustable armchair, polished aluminium swivel base with castors	680	680	760-890	430-560	986	1,070	1,137	1,573
	SPA006	Armchair, chrome stainless steel legs	570	540	775	470	932	983	1,064	1,494
	SPA023	Height adjustable armchair, polished aluminium swivel base	670	670	770-890	440-560	1,006	1,057	1,118	1,554

* Not every fabric from these ranges is available on standard Narbutas lead times - please see fabrics section at back of price list for details

Danae

Lounge chairs



Danae offers a simple yet sophisticated lounge chair with a soft and welcoming seat shape.

Choose from 4 base options to suit your requirements including swivel base with or without castors and steel or solid wood legs.

A wide range of fabric colours and finishes are available including genuine Leather.

Range

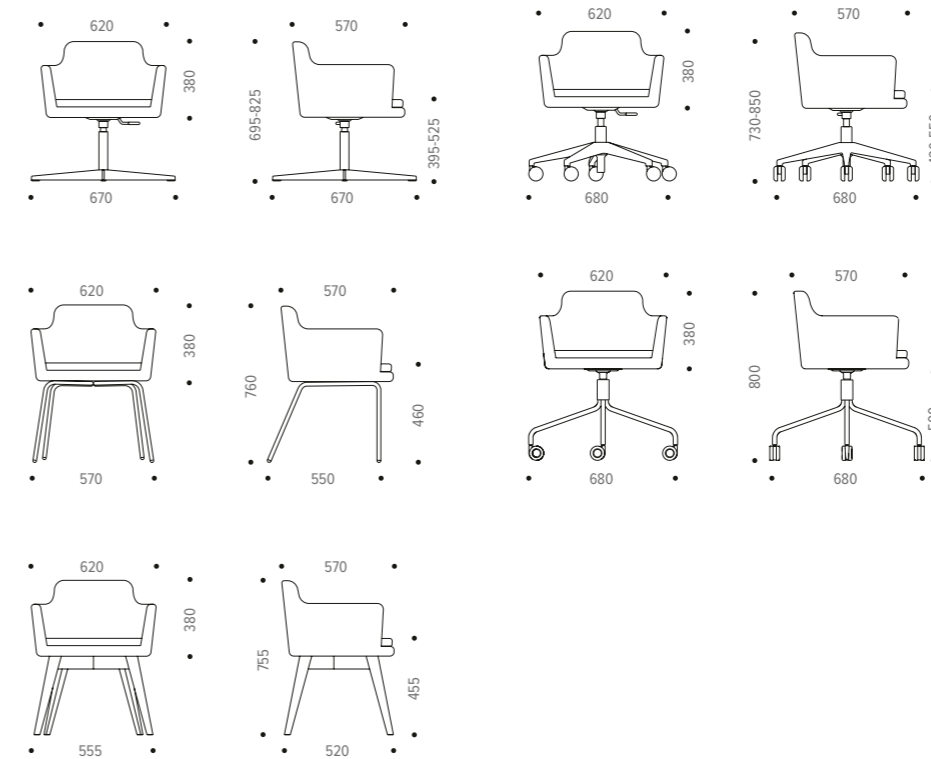

Technical

Frame and padding

- Steel framework moulded in polyurethane
- Fabric is glued and fixed from underside

Base

- Four-star aluminium base with 120mm run range gas lift
- Four-leg chromed tube frame Ø20mm
- Five-star aluminium base with 65mm castors (for soft or hard floor), 120mm run range gas lift
- Four-leg lacquered and stained light grey or black ash solid wood base
- Pyramid (four-star) base from bend Ø20mm steel rod, external Ø680mm, powder coated, with castors

Castors

- Rubber free wheel castors for hard floor, Ø65mm;
- PA (polyamide) free wheel castors for soft floor, Ø65mm
- Rubber free wheel hollow castors for hard floor, Ø65mm
- PA (polyamide) free wheel hollow castors for soft floor, Ø65mm

Materials

G1 Fabric*

Berta
Camira Era

G2 Fabric

Leather Look
Gabriel Step/Step Melange
Camira Xtreme 







G3 Fabric*

Valencia C5
Gabriel Cyber 
Velito
Camira Synergy

G4 Fabric

Genuine Leather

 Eco friendly

	CODE	DESCRIPTION	WIDTH	DEPTH	HEIGHT	SEAT	G1 (£)	G2 (£)	G3 (£)	G4 (£)
	SPA013	Height adjustable armchair, polished aluminium swivel base with castors	680	680	730-860	420-550	1,039	1,045	1,128	1,569
	SPA020	Armchair, chrome stainless steel legs	630	550	750	450	1,139	1,187	1,263	1,704
	SPA012	Height adjustable armchair, polished aluminium swivel base	670	670	690-820	390-520	1,149	1,208	1,272	1,707
	SPA021	Armchair, stained natural ash (W2) or ash stained black (W3) solid wood base	620	550	770	470	1,192	1,211	1,282	1,712
	SPA016/P1	Armchair, Steel framework. Base: swivelling, pyramid type powder-coated wire steel with solid castors. Seat height not adjustable.	680	680	800	500	1,062	1,114	1,160	1,497
	SPA016/P2	Armchair, Steel framework. Base: swivelling, pyramid type powder-coated wire steel with hollow castors. Seat height not adjustable.	680	680	800	500	1,120	1,172	1,213	1,549

Vegas

Lounge chairs



Range

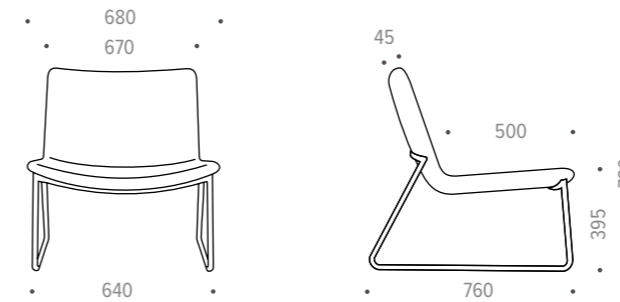

Technical

Frame

- Painted steel frame (Ø20mm) fixed with 4 screws
- Chrome steel frame (Ø20mm) fixed with 4 screws

Seat and back

- Wooden inner part with glued cold injected foam (HR3030 density: 28-31 kg/m3) and synthepon upholstered with fabric or leather

Materials

G1 Fabric*

Camira Era
Berta

G2 Fabric*

Leather Look
Gabriel Step/Step Melange
Camira Xtreme

G3 Fabric*

Velito
Camira Synergy

G4 Fabric

Genuine Leather

Frame

Black (A)
Grey (M)
Dark Grey (T1)
Chrome (H)

Eco friendly

	CODE	DESCRIPTION	WIDTH	DEPTH	HEIGHT	SEAT	G1 (£)	G2 (£)	G3 (£)	G4 (£)
	SPA015/P1	Lounge chair with ribbed stitching, painted steel base	690	727	730	320	1,117	1,143	1,274	1,643
	SPA017/P1	Lounge chair with one connecting stitch, painted steel base	690	725	730	320	1,103	1,129	1,260	1,536
	SPA015/P2	Lounge chair with ribbed stitching, polished chrome metal base	690	727	730	320	1,068	1,087	1,211	1,480
	SPA017/P2	Lounge chair with one connecting stitch, polished chrome metal base	690	725	730	320	1,103	1,129	1,260	1,536



The simple reclined form of the Vegas lounge chair means you can sink into it and remain comfortable.

Perfect for breakout meeting spaces and chillout zones the chrome sled style legs help it feel lightweight and subtle. Choose from a wide range of fabric finish options including genuine Leather.

* Not every fabric from these ranges is available on standard Narbutas lead times - please see fabrics section at back of price list for details

Pixel

Lounge seating + Sofas



The Pixel range offers 3 sofas in a range of fabric possibilities including genuine Leather.

The simple lines and reclined design make a smart but comfortable addition to your workspace, ideal for receptions, waiting areas or cosy training rooms.

Choose from 1 2 or 3 seater options which can be mixed and matched to suit your space.

Range

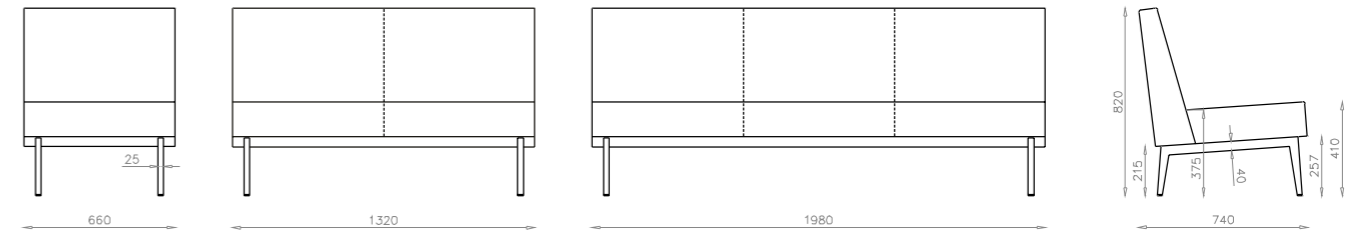

Technical

Frame

- Plywood, chipboard

Upholstery

- Combined 80kg/m³ RE (rebound R-type foam) – 30mm and 50kg/m³ HR (high resilience) – 60mm layers of polyurethane on zigzag springs in the seat, 40kg/m³ HR (high resilience) 60mm layer of polyurethane in the backrest

Cover

- Textile, vinyl or leather

Legs

- Painted metal frame (rectangular tube 40 x 25mm and 30 x 30mm, powder coating, anthracite grey (RAL 7016)), plastic glides

Materials

G1 Fabric



Leather Look

G2 Fabric*

Velito
Camira Synergy

G3 Fabric

Genuine Leather

	CODE	DESCRIPTION	WIDTH	DEPTH	HEIGHT	G1 (£)	G2 (£)	G3 (£)
	SWA100	1 seater sofa	660	740	820	2,494	2,652	3,124
	SWA200	2 seater sofa	1320	740	820	3,815	4,105	4,905
	SWA300	3 seater sofa	1980	740	820	5,121	5,511	6,651

* Not every fabric from these ranges is available on standard Narbutas lead times - please see fabrics section at back of price list for details

Cannie

NEW

Stools



Designed by the Italian studio S.I. Design, the **Cannie collection of stools combines high-quality materials into a simple yet playful design that is easily adaptable to different interiors.**

Available in three heights, Cannie may look like a simple stool, but it is guaranteed to offer high quality and comfort to its users. When sitting on a high or medium high stool, you can place your feet comfortably on the footrest.

Cannie stools are easy to disassemble, sort and recycle. The plastic seat and footrest are fully recyclable, as are

the solid wood legs. The varnish and paints are water-based and therefore have low emissions of volatile organic compounds.

Cannie stools of different heights can be used in office collaborative or meeting spaces, an office kitchen as well as in public spaces. Designers will enjoy combining these stools in different interiors and will be able to choose the colours of the legs, the footrest as well as the plastic of the hard part of the seat and upholstery of the seat. That is 1620 possible combinations in total!

Range

High stool

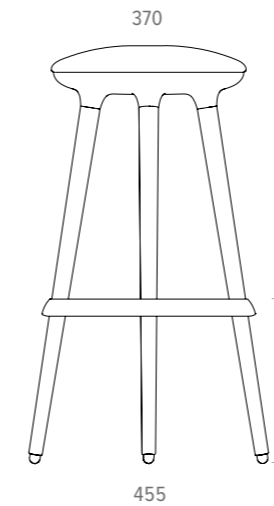

Medium stool

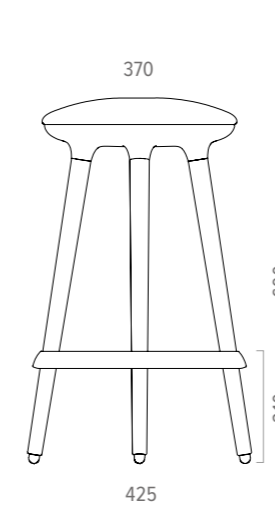

Low stool

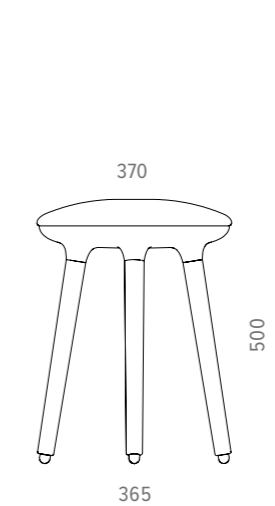

Technical details

Seat

- Outer cover made of PA plastic, reinforced with fibreglass
- Upholstery plate made of ABS plastic, seat made of moulded polyurethane (PU) and upholstered with fabric or leather look

Legs

- Lacquered wooden legs, fixed with metal fittings

Footrest

- Fixed height, made of PA (nylon) plastic, reinforced with fibreglass, fixed with metal fittings

Glides

- Round glides for soft and hard floors

Maximum load – 110kg

Materials

G1 Fabric*

Berta
Camira Era

G2 Fabric*

Leather Look
Gabriel Step/Step Melange
Camira Xtreme

G3 Fabric*

Spradling Valencia C5
Gabriel Cyber
Velito
Camira Synergy

Wooden legs

Stained Natural Ash (W2)
Ash stained Black (W3)

Plastic

White (PE1)
Dark Grey (PE5)
Sage Green (PE8)
Dark Coral (PE6)
Blue (PE4)
Mustard Yellow (PE7)

Eco friendly

	CODE	DESCRIPTION	WIDTH	DEPTH	HEIGHT	G1 (£)	G2 (£)	G3 (£)
	SCN001	High stool for H1050mm desks. Upholstered seat pad with plastic seat shell. Natural ash wood 4 leg base with plastic footrest and glides.	455	455	790	479	500	520
	SCN101	Medium high stool for H900mm desks. Upholstered seat pad with plastic seat shell. Natural ash wood 4 leg base with plastic footrest and glides.	425	425	690	453	479	500
	SCN201	Stool for H740mm desks. Upholstered seat pad with plastic seat shell. Natural ash wood 4 leg base on glides.	370	370	500	406	432	453

* Not every fabric from these ranges is available on standard Narbutas lead times - please see fabrics section at back of price list for details

Wobby

Pivoting task stool



Range

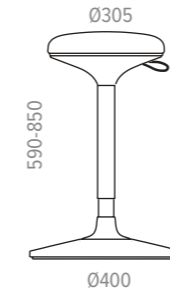

Technical

Seat

- Fixed, lower part (inner and outer) made of PP
- Foam made of PU
- Fabric, leather look or genuine leather upholstered

Mechanism

- Fixed, height adjustment by side leather strap

Gas lift

- Black colour
- 260mm run range

Base

- Black plastic base with integrated pivoting mechanism
- Non-slip rubber pads

Materials

G1 Fabric*

- Berta
- Camira Era
- Bondai

G2 Fabric*

- Leather Look
- Gabriel Step/Step Melange
- Camira Xtreme

G3 Fabric*

- Gabriel Cyber
- Velito
- Camira Synergy

G4 Fabric

- Genuine Leather

Eco friendly

The Wobby pivoting stool offers a healthier sitting alternative and a solution for increased productivity at work. The modern and sleek design is an ideal accompaniment for a sit/stand desk.

The unique pivoting system means the seat can be tilted up to 8 degrees in all directions and rotated 360 degrees, together with the stable, non-skid base surface allowing it to be used as a support when standing to work.

The seat height is simple to adjust to your individual needs using the elegant brown leather strap.

	CODE	DESCRIPTION	WIDTH	DEPTH	HEIGHT	G1 (£)	G2 (£)	G3 (£)	G4 (£)
	SEC010	Active seating task stool, height adjustable with tilting column, Ø400mm black plastic base	400	400	590-860	789	796	806	882

* Not every fabric from these ranges is available on standard Narbutas lead times - please see fabrics section at back of price list for details

Soft Rock

Modular soft seating

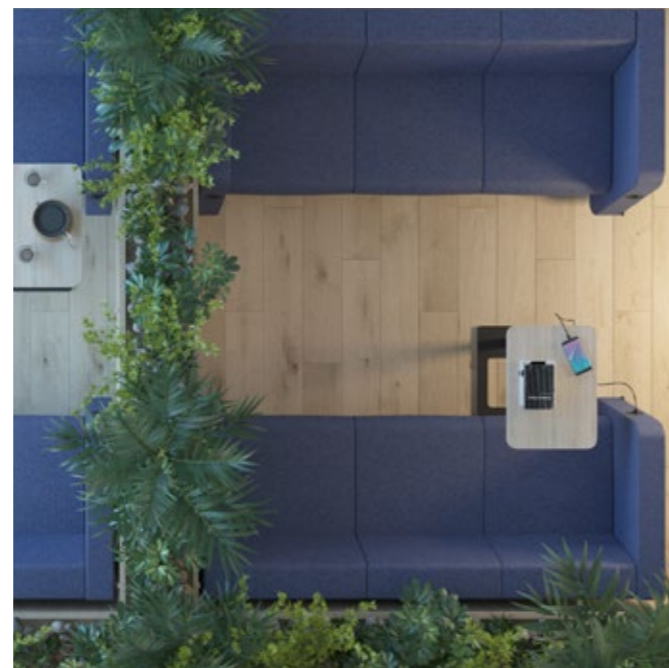

Soft Rock low-frame lounge seaters, with a distinctive backrest, blend subtly into all kinds of lounge or workspaces and help to create a welcoming, safe and calm atmosphere for relaxation, informal meetings, collaboration or individual tasks. The synergy between rounded shapes and straight lines creates a unique, eye-catching yet simple design.

The flexible modular system consists of a series of lounge seaters available in different sizes and forms which can be easily combined or rearranged to make efficient use of the space. Choose from six main lounge

seaters available in different sizes, with straight or curved lines, and with or without a backrest.

Screens can be harmoniously integrated into the seating combinations and can change their purpose, like creating a more private area for individual work that requires concentration within an open space.

Soft Rock offers its users a convenient way of charging their mobile phones, laptops or other smart devices. The armrests of the Soft Rock furniture have in-built power sockets or fast charging USB ports.

Range

Seaters

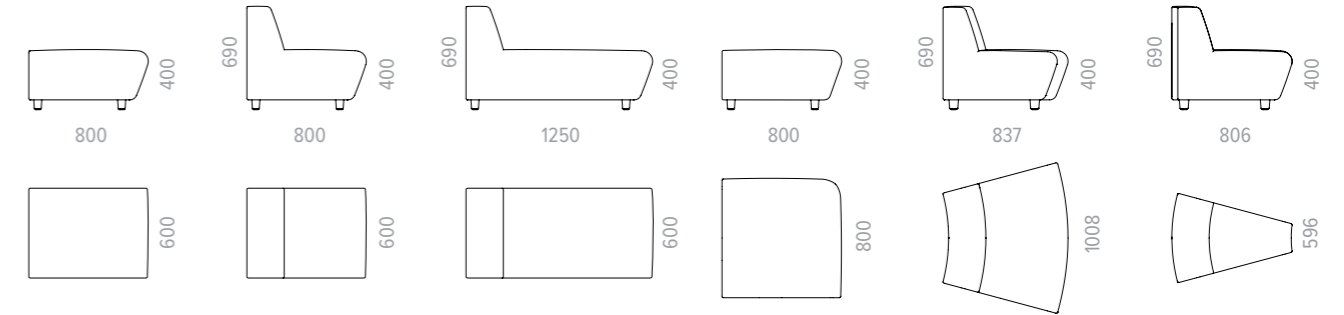

Armrests



Side armrests

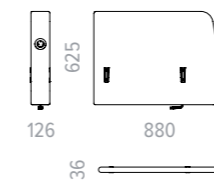

Screens

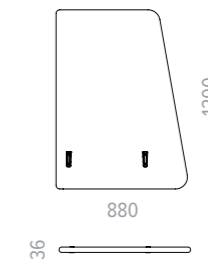
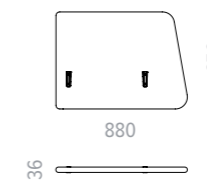

Screen with coffee table

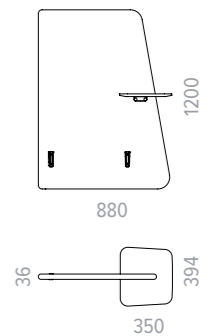

Seaters SRS1 SRS2 and SRS3 can have factory preassembled metal connectors for 3 sides: R/H (A), back (B) and L/H (C);



Seaters SRS101 SRS102 and SRS103 can have factory preassembled metal connectors for 2 sides: R/H (A) and L/H (B)

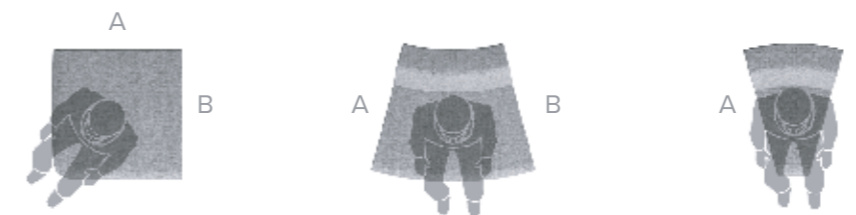

Materials

G1 Fabric*

Berta
Camira Era

G2 Fabric*

Leather Look
Camira Xtreme
Gabriel Step/Step Melange

G3 Fabric*

Valencia C5 - *Not on screens*
Gabriel Cyber
Velito
Camira Synergy

Tabletop

Oak veneer (AA)

Metal

Black (A)

Eco friendly

* Not every fabric from these ranges is available on standard Narbutas lead times - please see fabrics section at back of price list for details

Technical

Lounge seaters

- Black plastic feet with plastic glides (PP), height 63mm, 4 pcs (felted glides adds extra 3mm)
- Internal frames made from 15mm chipboard
- Curved internal frames made from 15mm chipboard and 15mm bent plywood
- Backrest fixed to the internal frame with 40x30 mm powder coated metal tubes
- Bottom plate made from 25mm MFC with 2mm ABS edging, fixed to the internal frame with 60x60 mm powder coated metal tube connectors
- Bottom plates have ability to install linking brackets
- Maximum functional load 110kg
- Preassembled metal connectors for side armrests or screens for quick mounting
- Seats made from moulded PU foam (density: 55kg/m³), hardness approx. 300N
- Backrests made from moulded PU foam (density: 55kg/m³), hardness approx. 250N
- Sides and backs softened with foam VB3842 (density: 36-39kg/m³)
- Upholstered with fabric or RNN, without gluing
- Linking brackets 50x15 mm black powder coated metal tube

Side armrests

- Internal frame 12mm, 25mm chipboard, 3mm HDF and 3mm flexible plywood
- Preassembled connectors (plastic) for quick mounting to lounge seaters
- 1 AC power socket 100 – 230 V (EU, UK, FR, CH, US) or USB fast charger (USB Type A+C, max 5A), cable ends with connector GST18i3 male, cable length – 1m
- Covered with foam VB3842 (density: 36-39 kg/m³)
- Upholstered with fabric or RNN

Armrests with metal base

- Internal frame 12mm chipboard and 3mm HDF
- 1 AC power socket 100 – 230 V (EU, UK, FR, CH, US) or USB fast charger (USB Type A+C, max 5A), cable ends with connector GST18i3 male, cable length – 1m
- Bottom base, for positioning between seaters, made from 3mm black powder coated metal sheet
- Covered with foam VB3842 (density: 36-39 kg/m³)
- Upholstered with fabric or RNN

Screens

- 16mm chipboard, covered with 10mm acoustic foam
- Preassembled connectors for mounting to seaters
- Upholstered with fabric or RNN

Screen table

- 18mm birch plywood, covered in veneer with sloping edges and R1mm rounded edges
- Mounting brackets made from 4mm black powder coated metal sheet
- Mounted 700mm from the ground (300mm from the seat)
- Bolts covered with black plastic (PE) caps

Power supply cables

- AC plug – GST18i3 female connector
- AC plug standards: EU, UK, FR, CH, US
- Cable lengths: 1 m and 3 m
- Cable core: 2mm² (EU, FR, UK, CH)
- Inline Overcurrent Protection (OCP 10A) (CH)
- Inline Overcurrent Protection fulfills statutory requirements: in the USA for more than 3 sockets, in Switzerland for more than 1 socket
- Black







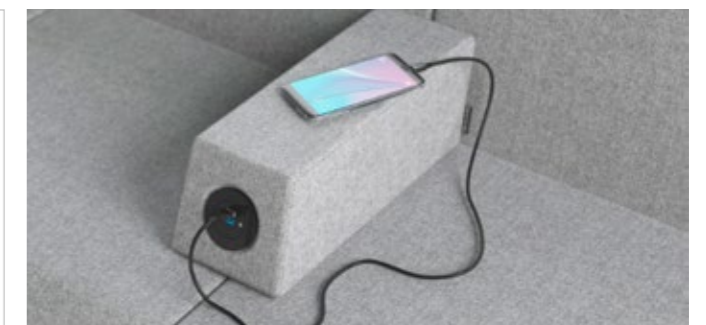

Extension cables

- GST18i3 female to male connector
- Cable lengths: 1m, 2m and 3m
- Cable core: 2mm² (EU, FR, UK, CH)
- Black









Distributor blocks

- GST18i3 1-2 block (1 male in, 2 female out), black
- GST18i3 1-3 block (1 male in, 3 female out), black
- GST18i3 1-5 block (1 male in, 5 female out), black



	CODE	DESCRIPTION	WIDTH	DEPTH	HEIGHT	G1 (£)	G2 (£)	G3 (£)
	SRS001	Lounge seater	600	800	400*	822	899	982
	SRS002	Lounge seater with backrest	600	800	690*	1,174	1,267	1,356
	SRS003	Lounge seater with backrest (long)	600	1250	690*	1,580	1,719	1,839
	SRS101	Corner lounge seater (90°)	800	800	400*	1,018	1,124	1,227
	SRS102	Curved lounge seater with backrest (+30°)	1008	837	690*	1,935	2,038	2,139
	SRS103	Curved lounge seater with backrest (-30°)	596	806	690*	1,375	1,459	1,537
	SRS201	Side armrest (R/H)	880	126	625 (688)*	409	508	618
	SRS202	Side armrest (L/H)	880	126	625 (688)*	409	508	618
	SRS203	Side armrest (Center)	880	126	625 (688)*	422	514	631







* Felt glides for hard floors (+) add 3 mm to lounge seater height

	CODE	DESCRIPTION	WIDTH	DEPTH	HEIGHT	G1 (£)	G2 (£)	G3 (£)
	SRS204	Side armrest (R/H) with 1 USB fast charger (type A+C). Power supply cable must be ordered separately	880	126	625 (688)*	888	986	1,091
	SRS205	Side armrest (L/H) with 1 USB fast charger (type A+C). Power supply cable must be ordered separately	880	126	625 (688)*	879	980	1,083
	SRS206	Side armrest (Center) with 1 USB fast charger (type A+C). Power supply cable must be ordered separately	880	126	625 (688)*	891	990	1,100
	SRS207	Side armrest (R/H) with 1 power socket. Power supply cable must be ordered separately	880	126	625 (688)*	562	661	765
	SRS208	Side armrest (L/H) with 1 power socket. Power supply cable must be ordered separately	880	126	625 (688)*	559	657	762
	SRS209	Side armrest (center) with 1 power socket Power supply cable must be ordered separately	880	126	625 (688)*	569	669	774
	SRS301	Armrest with metal base	435	168	145 (257) [†]	196	224	257
	SRS302	Armrest with metal base and 1 USB fast charger (type A+C). Power supply cable must be ordered separately.	435	168	145 (257) [†]	676	705	732
	SRS303	Armrest with metal base and 1 power socket Power supply cable must be ordered separately	435	168	145 (257) [†]	353	375	407

* Felt glides for hard floors (+) add 3 mm to lounge seater height
[†] Height with metal base

	CODE	DESCRIPTION	WIDTH	DEPTH	HEIGHT	G1 (£)	G2 (£)	G3 (£)
	SRS401	Low screen (R/H)	880	36	650 (713)*	284	311	351
	SRS402	Low screen (L/H)	880	36	650 (713)*	284	311	351
	SRS403	Low screen (Center)	880	36	650 (713)*	296	323	361
	SRS404	High screen (R/H)	880	36	1200 (1263)*	475	541	609
	SRS405	High screen (L/H)	880	36	1200 (1263)*	475	541	609
	SRS406	High screen (Center)	880	36	1200 (1263)*	489	550	621
	SRS407	Screen (Center) with plywood table (350x394 H=18 mm). Tabletop height - 700 mm from the ground	880	36	1200 (1263)*	623	685	757

* Height from the ground

	CODE	DESCRIPTION	WIDTH	DEPTH	HEIGHT	RSP (£)
	SRS000	Set of linking parts for lounge seaters	204	50	15	24
	PL-UKWF/01	1m power cable, mains to GST 3-pole female connector, black				17
	PL-UKWF/02	2m power cable, mains to GST 3-pole female connector, black				18
	PL-UKWF/03	3m power cable, mains to GST 3-pole female connector, black				22
	PL-WMWF/01	1m connector cable, GST 3-pole male to female connector, black				16
	PL-WMWF/02	2m connector cable, GST 3-pole male to female connector, black				19
	ZZZ366	Distributor block GST18i3 (1 IN, 2 OUT)				35
	ZZZ367	Distributor block GST18i3 (1 IN, 3 OUT)				45
	ZZZ368	Distributor block GST18i3 (1 IN, 5 OUT)				68

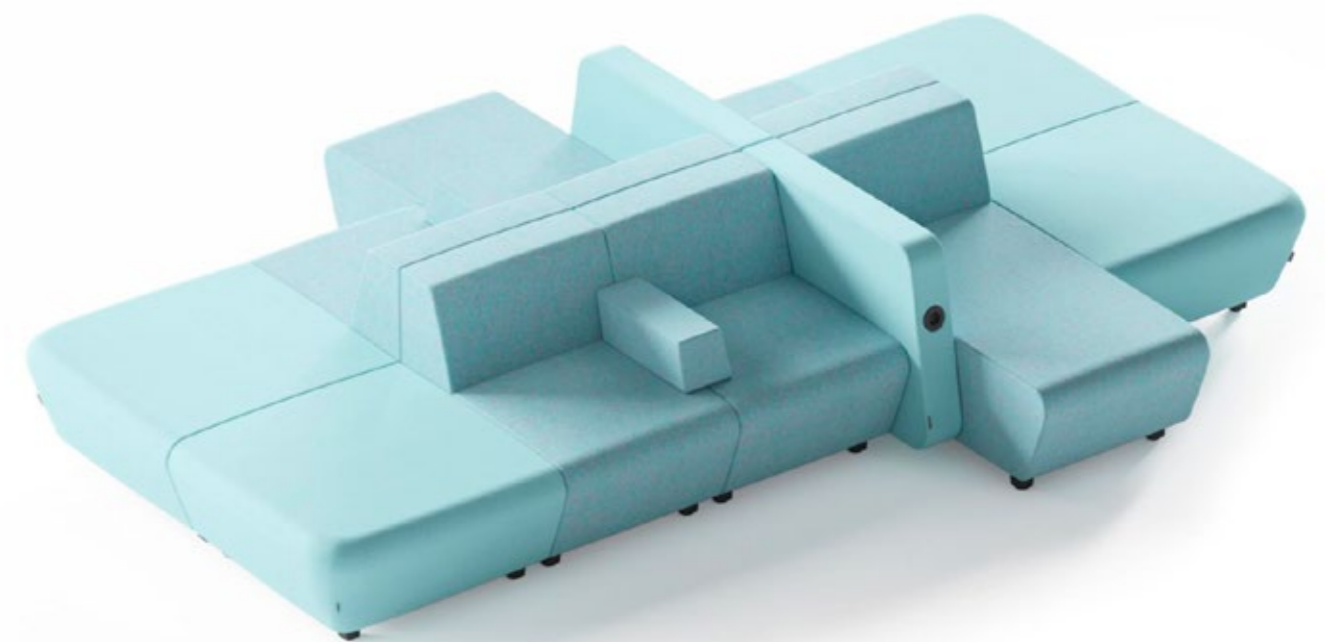

* Height with metal base

Jazz Chill Out

Modular soft seating

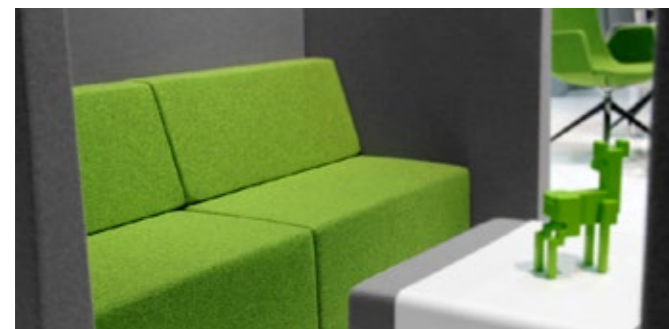

With its simple shapes and sharp lines Jazz modular soft seating works in almost any setting, ideal for reception and waiting areas and breakout spaces.

The sloped backrests and raised armrests provide a high level of comfort and the variety of fabrics available means that colours can be easily mixed and matched and swapped as desired.

The simple table design can be added in any section of seating and moved as required and aligned with power sockets in poufs to create a flexible individual workspace.

Jazz lounge seating works seamlessly with Jazz silent booth for increased privacy and sound absorption.

Fabrics can also be matched with Modus acoustic panels to create permanent alcove seating, ideal for dining areas and reception areas.

Works
with
Jazz Box

Range

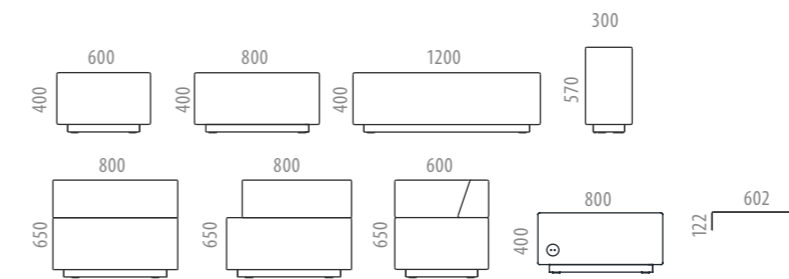

Technical

Frame

- Made from 15mm plywood and 15mm chipboard, poufs with backrest also has 40 x 30 x 2 mm metal tube
- Backrest frame made from 15mm plywood, 25mm chipboard and 25 x 25 x 2 mm metal tube

Padding

- Frame top coated by foam HR5050 (density: 48-51 kg/m³), lower layer of the foam HR3030 (density: 28-32kg/m³); frame sides coated by foam HR3030 (density: 28-32 kg/m³)
- Backrest frame coated by foam HR5050 (density: 48-51 kg/m³)

Power socket

- Power insert available with UK, EU, FR or CH type socket
- Cable length 2 meters

Seat

- Black metal base (50 x 20 x 2 mm) with 4 plastic supports (5mm)
- Linking brackets available for creation of combinations

Materials





Fabric*





Berta
Camira Era
Gabriel Step/Step Melange
Camira Xtreme 
Gabriel Cyber 
Velito
Camira Synergy
Leather Look
Valencia C5
Genuine Leather



Metal

Black (A)
White (E) - Table only





 Eco friendly

G1: Berta Era		G2: Leather Look Xtreme Step/Step Melange		G3: Valencia C5 Cyber Velito Synergy		G4: Genuine Leather				
	CODE	DESCRIPTION	WIDTH	DEPTH	HEIGHT	SEAT	G1 (£)	G2 (£)	G3 (£)	G4 (£)
	SGA100	Pouf. Base - black painted metal.	600	600	400	400	575	609	691	1,015
	SGA101	Pouf. Base - black painted metal.	800	600	400	400	783	830	923	1,381
	SGA200	Pouf. Base - black painted metal.	1200	600	400	400	981	1,044	1,224	1,862
	SGA102	Pouf. Base - black painted metal.	300	600	570	570	534	575	691	1,044

G1: Berta Era		G2: Leather Look Xtreme Step/Step Melange		G3: Valencia C5 Cyber Velito Synergy		G4: Genuine Leather				
	CODE	DESCRIPTION	WIDTH	DEPTH	HEIGHT	SEAT	G1 (£)	G2 (£)	G3 (£)	G4 (£)
	SGA107/P1	Pouf with power socket on left hand side. Base - black painted metal.	800	600	400	400	969	1,021	1,108	1,798
	SGA108/P1	Pouf with power socket on right hand side. Base - black painted metal.	800	600	400	400	969	1,021	1,108	1,798
	SGA111/P1	Pouf with USB fast charger on left hand side. Base - black painted metal.	800	600	400	400	1,207	1,253	1,352	1,990
	SGA112/P1	Pouf USB fast charger on right hand side. Base - black painted metal.	800	600	400	400	1,207	1,253	1,352	1,990

	CODE	DESCRIPTION	WIDTH	DEPTH	HEIGHT	RSP (£)
	SGZ001	Metal table, black or white	602	400	122	227
	ZGZ004	Linking brackets (2pcs) for creating combinations, black	40	45	113	41

G1: Berta	G2: Era	G3: Leather Look	G4: Xtreme		G5: Step/Step Melange						
	CODE	DESCRIPTION	WIDTH	DEPTH	HEIGHT	SEAT	G1 (£)	G2 (£)	G3 (£)	G4 (£)	G5 (£)
	SGA103/P1	Pouf with backrest (800x200, H=250). Base - black painted rectangular metal tube/frame.	800	600	650	400	1,044	1,044	1,108	1,108	1,108
	SGA104/P1	Pouf with right side backrest (700x200, H=250). Base - black painted metal.	800	600	650	400	969	969	1,073	1,073	1,073
	SGA105/P1	Pouf with left side backrest (700x200, H=250). Base - black painted metal.	800	600	650	400	969	969	1,073	1,073	1,073
	SGA106/P1	Pouf with angular backrest (600x600, H=250). Base - black painted metal.	600	600	650	400	1,039	1,039	1,126	1,126	1,126

G1: Valencia C5	G2 SEAT: Synergy G2 BACKREST: Synergy Cyber	G3: Velito	G4: Cyber		G5: Genuine Leather						
	CODE	DESCRIPTION	WIDTH	DEPTH	HEIGHT	SEAT	G1 (£)	G2 (£)	G3 (£)	G4 (£)	G5 (£)
	SGA103/P2	Pouf with backrest (800x200, H=250). Base - black painted rectangular metal tube/frame.	800	600	650	400	1,265	1,265	1,265	1,265	1,903
	SGA104/P2	Pouf with right side backrest (700x200, H=250). Base - black painted metal.	800	600	650	400	1,236	1,236	1,236	1,236	1,810
	SGA105/P2	Pouf with left side backrest (700x200, H=250). Base - black painted metal.	800	600	650	400	1,236	1,236	1,236	1,236	1,810
	SGA106/P2	Pouf with angular backrest (600x600, H=250). Base - black painted metal.	600	600	650	400	1,253	1,253	1,253	1,253	2,332

Giro

Poufs



Easy to move and transport due to their lightweight design Giro poufs make a colourful but practical addition to any workspace.

Available in 2 different heights and 3 widths with optional castors and a variety of fabric possibilities Giro poufs allow you to quickly and easily create inviting breakout spaces in any area of your workspace.

Range



Technical

Frame

- 15mm chipboard and 3mm flexible plywood

Padding

- Upper frame is foam coated HR5050 (density: 48-51 kg/m³)
- Frame sides are foam coated HR3030 (density: 28-32 kg/m³)

Base

- 12mm black MFC round base with 1mm ABS edging
- Bottom finish - 5 x plastic H5mm glides or 5 x H45mm castors

Castors

- Maximum functional load 40kg per castor
- Ø37mm PU tread coated black wheel castors for hard floor
- Ø37mm PA6 black wheel castors for soft floor

Materials

G1 Fabric*

Berta
Camira Era

G2 Fabric*

Leather Look
Gabriel Step/Step Melange





G3 Fabric*

Valencia C5
Gabriel Cyber 
Velito
Camira Synergy

G4 Fabric

Genuine Leather

 Eco friendly

	CODE	DESCRIPTION	WIDTH	HEIGHT	G1 (£)	G2 (£)	G3 (£)	G4 (£)
	SRA100	Round pouf with black melamine base and castors	Ø400	490	319	336	377	606
	SRA101	Round pouf with black melamine base and plastic supports	Ø400	450	257	275	342	552
	SRA102	Round pouf with black melamine base and plastic supports	Ø600	350	403	421	468	802
	SRA103	Round pouf with black melamine base and plastic supports	Ø800	350	614	637	708	1,207

* Not every fabric from these ranges is available on standard Narbutas lead times - please see fabrics section at back of price list for details

Arcipelago

Modular soft seating

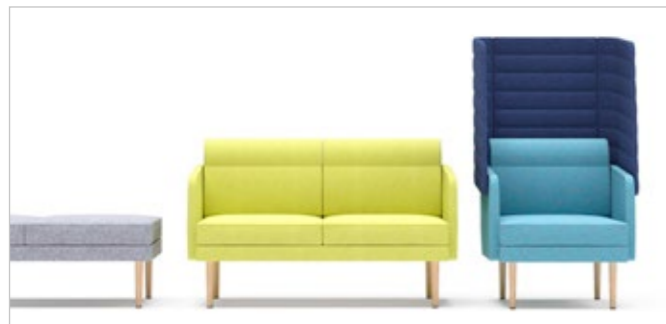

Create modern and functional office or public spaces with Arcipelago, a modular lounge seating system offering endless configuration possibilities whether individual workspaces, waiting areas, private meeting spaces or open meeting areas.

Thanks to its flexibility and 3 different height adjustment options, Arcipelago is a great choice for workspaces of any size and style. The high-back option provides more privacy and acoustic comfort.

Choose from a wide range of fabrics and colours or mix and match them to create a unique style for your office. Backrests and seat cushions can be easily removed and swapped. Choose your favourite configuration from standard options or build your custom configurations by mixing and matching modular components. Arcipelago is easy to assemble, disassemble or reassemble.

Arcipelago comes with well-designed accessories including: tables mounted between seats with integrated power socket and USB fast charger, mobile tables and armrests with power socket and USB fast charger.

Range

Pouf

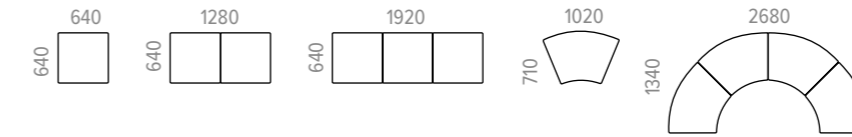

Sofa

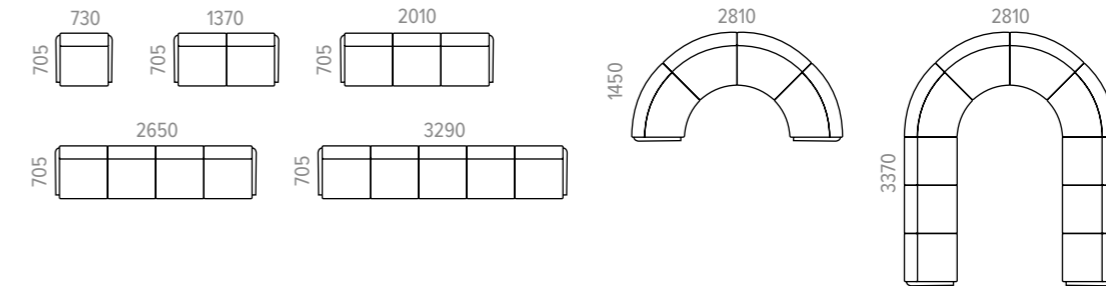

Sofa with high back

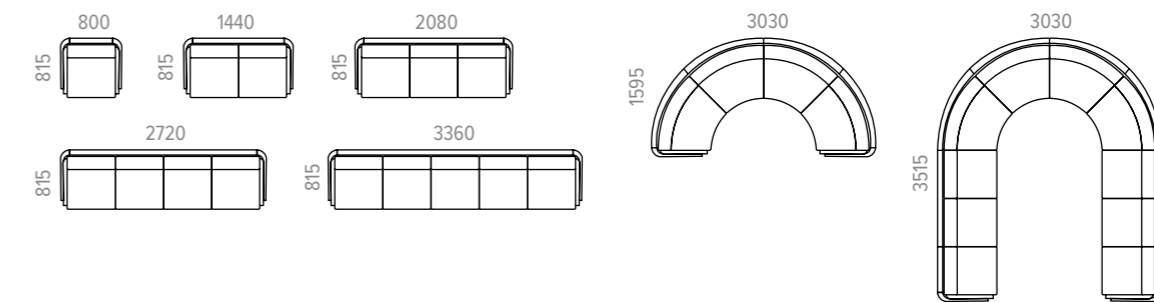

Segments for combinations

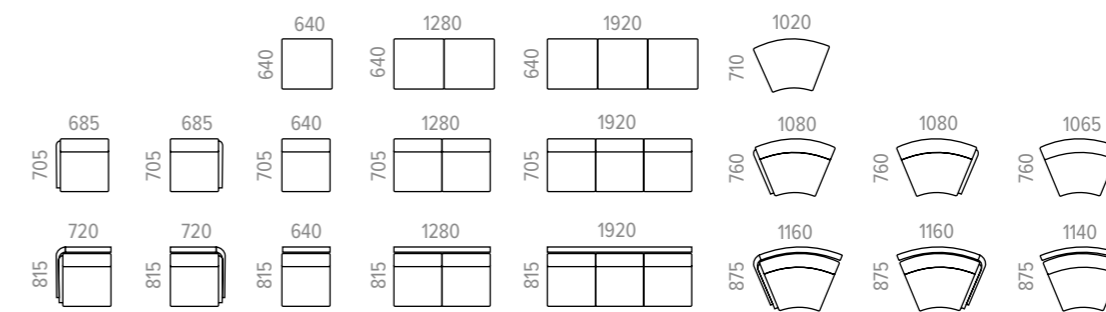

Fixed table



Armrest



Additional dimensions

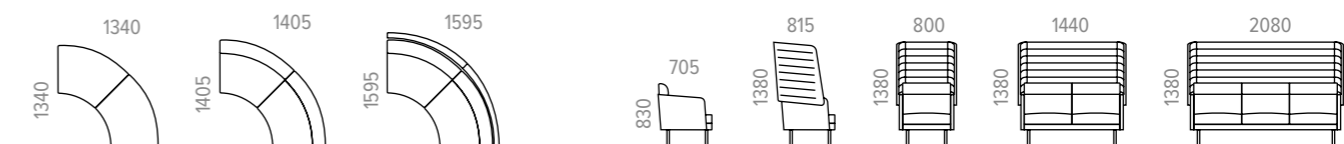

Technical

Base frames

- One seater base frame (640 x 640 x 80 mm)
- Two seater base frame (1280 x 640 x 80 mm)
- Three seater base frame (1920 x 640 x 80 mm)
- One seater curved base frame 45° (1020 x 690 x 80 mm)
- Base frames are made from metal tubes 70x20x2 mm and 50 x 20 x 2 mm
- Outer side of base frames are softened with foam HR5050 (48-51 kg/m³)
- Upholstery to the base frame attached with hook and loop straps

Legs

- Round wooden legs Ø48mm x H256 mm with height adjustable plastic feet (+10mm), seat H420mm (pricelist standard)
- Metal tube legs Ø30 x 263 mm with height adjustable plastic feet, (+10mm), seat H420mm (pricelist standard)
- Metal tube legs Ø30 x 293 mm with height adjustable plastic feet, (+10mm), seat H450mm (optional change)

Back cushion

- One seater straight back cushion (650 x 420 x 200 mm)
- One seater curved 45° seat cushion (1070 x 420 x 200 mm)
- Made from PU foam (50kg/m³)
- Upholstered with fabric
- Back side sewed with soft hook and loop strap

Side armrests and backrests

- Internal metal frame molded with PU foam (70kg/m³)
- Upholstered with fabric
- Backrests with hard Velcro strap in front to bind with back cushion

High back sides

- Internal metal frame molded with PU foam (100kg/m³)
- Upholstered with fabric
- Connected with zippers on the sides

Connecting brackets

- Armrest and backrest connecting brackets, base frames connecting brackets ('U' shape) and metal brackets for table connection ('L' shape) made of metal sheet (8mm)
- High back sides connecting brackets made from plastic (PA66+15GF)

Seat cushion

- One seater square seat cushion (650 x 650 x 130 mm)
- One seater curved seat cushion 45° (1030 x 710 x 130 mm)
- Made from PU foam (65-70 kg/m³)
- Upholstered with fabric
- Sewn with soft round 'velcro' pads on the bottom
- Seat cushions placed on MFC board, stuck with hard hook and loop pads

Armrest with power sockets

- Internal frame made of 15mm chipboard
- Covered with foam (HR5050 (48-51 kg/m³), VB3842 (36-39 kg/m³))
- Upholstered with fabric
- 1 x power socket with 2m cable
- Bottom base for positioning between seat cushions from 3mm metal sheet

Integrated tables

- Frame made of 18mm MFC with 1mm ABS edging (640 x 640 x 200 mm)
- H420mm above the ground – same as seat cushion
- 1 x EU, UK, FR or CH type power socket with 2m cable (SHD62), USB A + C fast charging module (SHD63)

Mobile table

- Table top 16mm MFC (500 x 400 mm) with 1mm ABS edging
- 8mm metal plate underneath table top
- Vertical powder coated metal column tube (40 x 40 x 2 mm)
- 8mm metal base with 4 adhesive felt glides

Materials

Fabrics*

Berta
Valenca C5
Camira Synergy
Gabriel Cyber ♻️
Step/Step Melange

Band A MFC

Whitened Oak (D1)
Amber Oak (D2)
White (M1)
Pearl Grey (N3)

Band B MFC













Sand Ash (D3)
Dark Walnut (D4)
Grey Wood (D5)
Cubanit Grey (N2)







Veneer







Oak (AA)
Maple (KK)
Walnut (RR)
Ash (V1)









Metal Legs



Black Metal (A)
White Metal (E)
Grey Metal (M)









	G1: Metal Legs Berta	G2: Wooden Legs Berta	G3: Metal Legs Step/Step Melange	G4: Wooden Legs Step/Step Melange	G5: Metal Legs Valencia C5 Cyber Synergy	G6: Wooden Legs Valencia C5 Cyber Synergy					
	CODE	DESCRIPTION	WIDTH	DEPTH	HEIGHT	G1 (£)	G2 (£)	G3 (£)	G4 (£)	G5 (£)	G6 (£)
	SHA100	1 seater pouf	640	640	420	653	787	675	817	759	899
	SHA200	2 seater pouf	1280	640	420	1,109	1,244	1,156	1,297	1,297	1,439
	SHA300	3 seater pouf	1920	640	420	1,570	1,704	1,663	1,805	1,816	1,958
	SHA101	1 seater curved pouf	1020	710	420	908	1,044	978	1,118	1,060	1,202
	SHA400	4 seater curved pouf	2680	1340	420	3,640	3,987	3,793	4,141	4,186	4,534
	SHA102	1 seater sofa	730	705	830	2,075	2,217	2,217	2,351	2,398	2,540
	SHA201	2 seater sofa	1370	705	830	3,086	3,228	3,292	3,428	3,605	3,744
	SHA301	3 seater sofa	2010	705	830	3,971	4,112	4,288	4,431	4,654	4,794
	SHA401	4 seater sofa	2650	705	830	5,793	6,076	6,170	6,454	6,717	6,993
	SHA402	4 seater curved sofa	2810	1450	830	8,573	8,918	9,054	9,401	10,059	10,407
	SHA500	6 seater sofa	3290	705	830	6,686	6,970	7,210	7,491	7,767	8,051
	SHA010	10 seater curved sofa	2810	3370	830	16,071	16,695	17,099	17,723	18,752	19,381









G1: Metal Legs Berta		G2: Wooden Legs Berta		G3: Metal Legs Step/Step Melange		G4: Wooden Legs Step/Step Melange		G5: Metal Legs Valencia C5 Cyber Synergy		G6: Wooden Legs Valencia C5 Cyber Synergy	
	CODE	DESCRIPTION	WIDTH	DEPTH	HEIGHT	G1 (£)	G2 (£)	G3 (£)	G4 (£)	G5 (£)	G6 (£)
	SHA104	1 seater pouf segment	640	640	420	628	693	652	723	740	804
	SHA204	2 seater pouf segment	1280	640	420	1,086	1,150	1,138	1,203	1,280	1,344
	SHA303	3 seater pouf segment	1920	640	420	1,546	1,610	1,645	1,708	1,792	1,862
	SHA105	1 seater curved pouf segment	1020	710	420	882	954	954	1,025	1,043	1,107
	SHA1R0	Right side 1 seater sofa segment	685	705	830	1,706	1,773	1,842	1,907	1,990	2,053
	SHA1L0	Left side 1 seater sofa segment	685	705	830	1,711	1,775	1,845	1,910	1,992	2,057
	SHA1M0	Middle 1 seater sofa segment	640	705	830	1,328	1,398	1,409	1,479	1,556	1,622





	CODE	DESCRIPTION	WIDTH	DEPTH	HEIGHT	G1 (£)	G2 (£)	G3 (£)	G4 (£)	G5 (£)	G6 (£)
	SHA2M0	Middle 2 seater sofa segment	1280	705	830	2,343	2,406	2,495	2,560	2,761	2,824
	SHA3M0	Middle 3 seater sofa segment	1920	705	830	3,236	3,299	3,534	3,599	3,811	3,882
	SHA1R1	Right side 1 seater curved sofa segment	1080	760	830	2,345	2,415	2,510	2,581	2,756	2,822
	SHA1L1	Left side 1 seater curved sofa segment	1080	760	830	2,349	2,418	2,513	2,583	2,761	2,825
	SHA1M1	Middle 1 seater curved sofa segment	1080	705	830	1,973	2,037	2,126	2,191	2,325	2,397
	SHA1M4	Middle angular (90°) one seater segment with 2 legs	705	705	830	2,177	2,241	2,301	2,364	2,470	2,535

	G1: Metal Legs Berta		G3: Metal Legs Step/Step Melange			G5: Metal Legs Cyber			G4: Metal Legs Synergy	
	CODE	DESCRIPTION	WIDTH	DEPTH	HEIGHT	G1 (£)	G2 (£)	G3 (£)	G4 (£)	
	SHA103/P1	1 seater highback sofa	800	815	1380	3,506	3,696	4,049	4,049	
	SHA203/P1	2 seater highback sofa	1440	815	1380	4,800	5,102	5,606	5,606	
	SHA302/P1	3 seater highback sofa	2080	815	1380	5,936	6,424	6,984	6,984	
	SHA403/P1	4 seater highback sofa	2720	815	1380	8,496	9,067	9,912	9,912	
	SHA501/P1	6 seater highback sofa	3360	815	1380	9,627	10,372	11,279	11,279	
	SHA404/P1	4 seater curved highback sofa	3030	1595	1380	12,438	13,306	14,700	14,700	
	SHA11/P1	10 seater curved highback sofa	3030	3515	1380	22,266	23,851	26,214	26,214	
	SHA1R2/P1	Right side 1 seater highback sofa segment	720	815	1380	2,694	2,890	3,170	3,170	



	CODE	DESCRIPTION	WIDTH	DEPTH	HEIGHT	G1 (£)	G2 (£)	G3 (£)	G4 (£)
	SHA1L2/P1	Left side 1 seater highback sofa segment	720	815	1380	2,694	2,890	3,170	3,170
	SHA1M2/P1	Middle 1 seater highback sofa segment	640	815	1380	1,820	1,949	2,145	2,145
	SHA2M1/P1	Middle 2 seater highback sofa segment	1280	815	1380	3,114	3,366	3,719	3,719
	SHA3M1/P1	Middle 3 seater highback sofa segment	1920	815	1380	4,245	4,671	5,085	5,085
	SHA1R3/P1	Right side 2 seater curved highback sofa segment	1160	875	1380	3,596	3,892	4,279	4,279
	SHA1L3/P1	Left side 2 seater curved highback sofa segment	1160	875	1380	3,596	3,892	4,279	4,279
	SHA1M3/P1	Middle 2 seater curved highback sofa segment	1140	875	1380	2,716	2,940	3,226	3,226
	SHA1M5/P1	Highback middle angular (90°) one seater segment with 2 legs	815	815	1380	3,304	3,534	3,736	3,736





G1: Wooden Legs Berta	G3: Wooden Legs Step/Step Melange	G5: Wooden Legs Cyber	G4: Wooden Legs Synergy							
				CODE	DESCRIPTION	WIDTH	DEPTH	HEIGHT	G1 (£)	G2 (£)
	SHA103/P2	1 seater highback sofa	800	815	1380	3,663	3,853	4,212	4,212	
	SHA203/P2	2 seater highback sofa	1440	815	1380	4,956	5,259	5,768	5,768	
	SHA302/P2	3 seater highback sofa	2080	815	1380	6,099	6,580	7,140	7,140	
	SHA403/P2	4 seater highback sofa	2720	815	1380	8,809	9,386	10,226	10,226	
	SHA501/P2	6 seater highback sofa	3360	815	1380	9,940	10,691	11,598	11,598	
	SHA404/P2	4 seater curved highback sofa	3030	1595	1380	12,830	13,698	15,092	15,092	
	SHA11/P2	10 seater curved highback sofa	3030	3515	1380	22,972	24,556	26,920	26,920	
	SHA1R2/P2	Right side 1 seater highback sofa segment	720	815	1380	2,772	2,963	3,243	3,243	

	CODE	DESCRIPTION	WIDTH	DEPTH	HEIGHT	G1 (£)	G2 (£)	G3 (£)	G4 (£)
	SHA1L2/P2	Left side 1 seater highback sofa segment	720	815	1380	2,772	2,963	3,243	3,243
	SHA1M2/P2	Middle 1 seater highback sofa segment	640	815	1380	1,893	2,022	2,218	2,218
	SHA2M1/P2	Middle 2 seater highback sofa segment	1280	815	1380	3,187	3,439	3,792	3,792
	SHA3M1/P2	Middle 3 seater highback sofa segment	1920	815	1380	4,318	4,744	5,158	5,158
	SHA1R3/P2	Right side 2 seater curved highback sofa segment	1160	875	1380	3,674	3,965	4,352	4,352
	SHA1L3/P2	Left side 2 seater curved highback sofa segment	1160	875	1380	3,674	3,965	4,352	4,352
	SHA1M3/P2	Middle 2 seater curved highback sofa segment	1140	875	1380	2,789	3,019	3,304	3,304
	SHA1M5/P2	Highback middle angular (90°) one seater segment with 2 legs	815	815	1380	3,383	3,607	3,808	3,808

G1: Band A MFC		G2: Band B MFC			G3: Veneer			
	CODE	DESCRIPTION	WIDTH	DEPTH	HEIGHT	G1 (£)	G2 (£)	G3 (£)
	SHD060	Table with connections for mounting between seats	640	640	200	470	523	687
	SHD062	Table with connections for mounting between seats and power socket	640	640	200	758	799	910
	SHD063	Table with connections for mounting between seats and USB A+C Fast Charge module	640	640	200	965	995	1,125
	SHD041	Mobi table with metal base	400	500	620	527	540	552

G1: Berta
G2: Step/Step Melange
G3: Valencia C5 / Cyber / Synergy

	CODE	DESCRIPTION	WIDTH	DEPTH	HEIGHT	G1 (£)	G2 (£)	G3 (£)
	SHZ006	Upholstered armrest with power socket	185	420	210	659	694	737
	SHZ007	Upholstered armrest with USB A+C Fast Charge	185	420	210	922	957	1,004

	CODE	DESCRIPTION	WIDTH	DEPTH	HEIGHT	RSP (£)
	SHZ001	Pair of connecting brackets <i>Must be ordered for each connection of any two segments in modular system combination</i>	-	-	-	62
	SHZ003	Pair of metal legs, to complete combination in white (E2), grey (M2) or black (A3) <i>One set must be ordered to complete each modular system combination</i>	-	-	-	26
	SHZ003-W1	Pair of natural ash wooden legs, to complete combination <i>One set must be ordered to complete each modular system combination</i>	-	-	-	97
	SHZ003-W3	Pair of ash stained black wooden legs, to complete combination <i>One set must be ordered to complete each modular system combination</i>	-	-	-	97

Accessories

Monitor arms

Power modules

Cable management

CPU holders

Anti-fatigue mats

Drawers

Coat stands



Kardo

Pole-mounted monitor arms

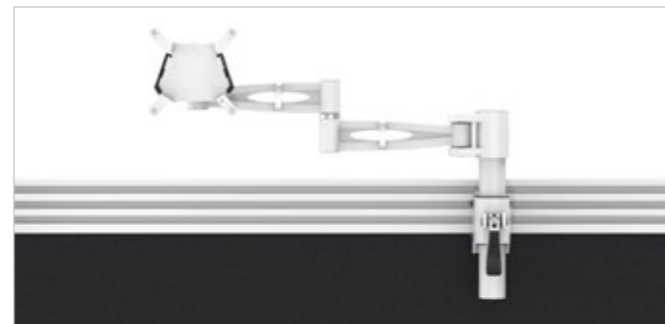

The Kardo fixed pole monitor arm is popular worldwide due to its appealing aesthetic and easy install design features.

We launched our first pole-mounted monitor arm in 2013 to help office workers avoid the risks associated with display screen equipment and save valuable desk space. Our Kardo range has proved very popular and now includes arms for single, twin and quad screen setups.

Materials

- Metal**
- Black (BK)
- White (WH)
- Grey (SV)

Quick release 75mm/100mm VESA mounting plates as standard with hand turn fixing screws



Quick release arm height adjustment

EASY TO INSTALL
No tools required!

FIRA Certified to:
BS EN ISO 9241 Workplace Ergonomics
PP 045 Safety and Durability

Includes pre-assembled clamp plus through-desk fixing option



Integrated cable management keeps your workspace clear



VESA plates slide onto Kardo arm with fixing clips to hold screen in place



Hand-turn desk edge clamp and through-desk clamp included



Brighten your workspace with an integrated flower holder in the pole

Technical details

- VESA quick-release mounting plates 75mm and 100mm
- Pre-assembled hand-turn desk edge clamp and through-desk fixing included (PMA521, PMA522, PMA523, PMA524)
- Low profile mini-clamp option
- Tool rail mounted arm option for single screen/monitor
- Inverted single arm option to convert single to twin
- Powder-coated steel, available in Black, Grey or White
- Certified to: BS EN ISO 9241 Workplace Ergonomics, PP 045 Safety & Durability

Single Arm

- H400mm pole
- 12.5kg screen/monitor weight capacity
- 32" screen/monitor size capacity

Single

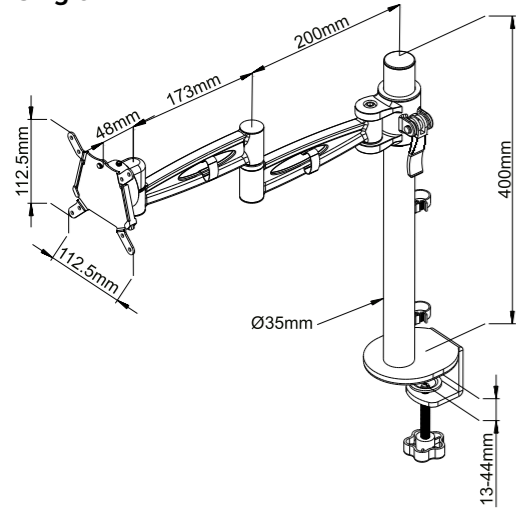

Dual/Twin Arm

- H400mm pole
- 20kg (2 x 10kg) screen/monitor weight capacity
- 2 x 27" screen/monitor size capacity

Triple Arm

- H700mm pole
- 30kg (3 x 10kg) screen/monitor weight capacity
- 3 x 27" screen/monitor size capacity

Quad Arm

- H700mm pole
- 32kg (4 x 8kg) screen/monitor weight capacity
- 4 x 27" screen/monitor size capacity

Toolrail

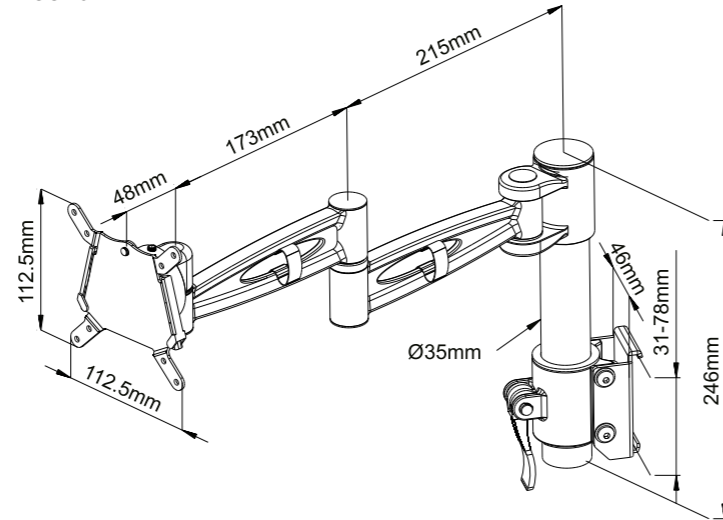



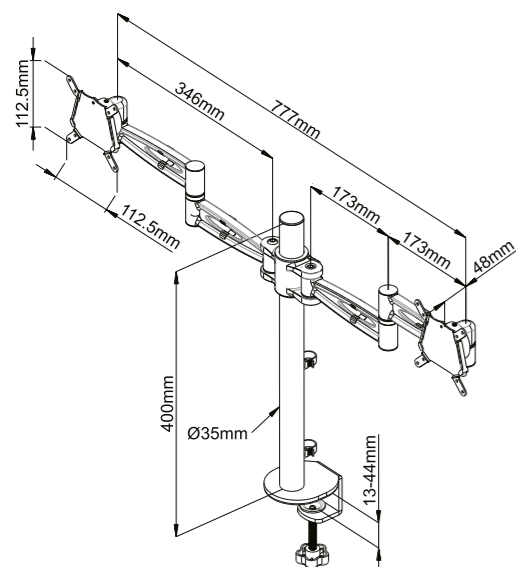



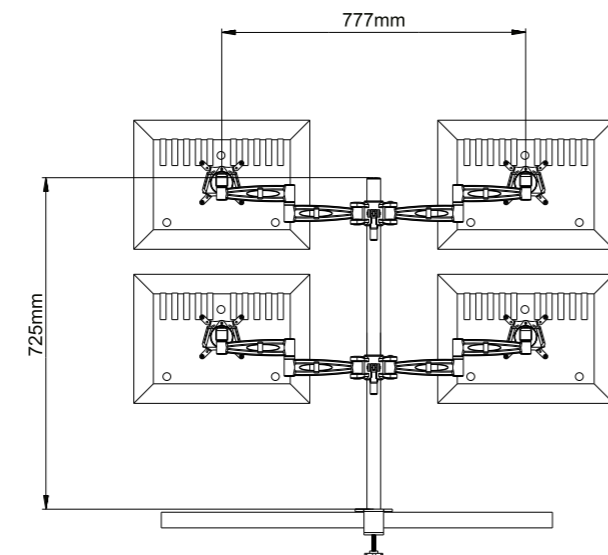

Dual/Twin

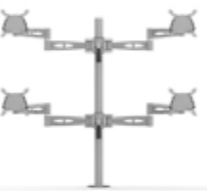

Quad



	CODE	DESCRIPTION	RSP (£)
	PMA521	Pole mounted monitor arm for single (1) screen 12.5 kg capacity	130
	PMA522	Pole mounted monitor arm for dual/twin (2) screens 2 x 10kg capacity	195
	PMA523	Pole mounted monitor arm for triple (3) screens 3 x 10kg capacity	347
	PMA524	Pole mounted monitor arm for quad (4) screens 4 x 8kg capacity	412
	PMSA521	Tool rail pole mounted monitor arm for single (1) screen 6kg capacity	127
	PMAOI-521	Inverted single arm only - to convert single to dual/twin 12.5kg capacity <i>Pole and desk-edge clamp not included</i>	112
	NBT101	Quick-release universal laptop holder attachment 10kg capacity	66
	EP550	550mm high pole only <i>Desk-edge clamp not included</i>	20
	EP700	700mm high pole only <i>Desk-edge clamp not included</i>	22
	KMC1827	Low profile mini desk-edge clamp	14

Duro

Heavy duty monitor arms

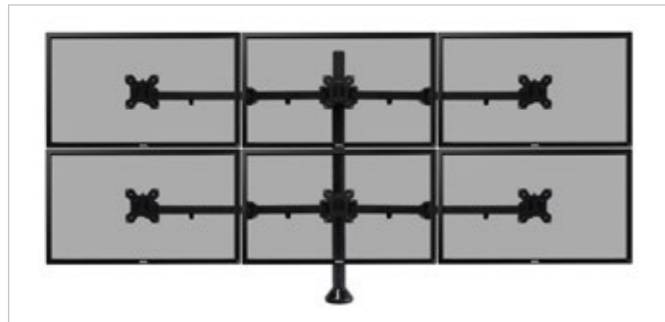
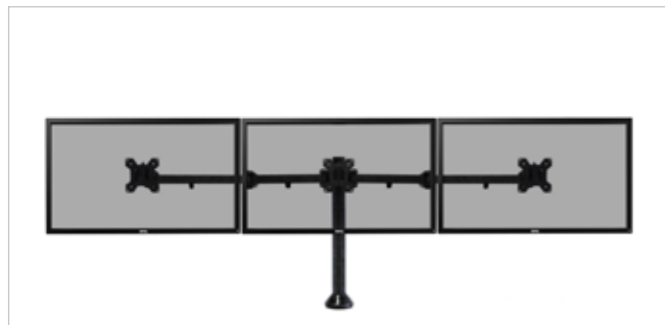

Create the ultimate multi-tasking display with our heavy duty three and six screen monitor arms.

Perfect for a range of different uses from a busy stock exchange to surveillance or even gaming and multimedia entertainment rigs.

3 screens

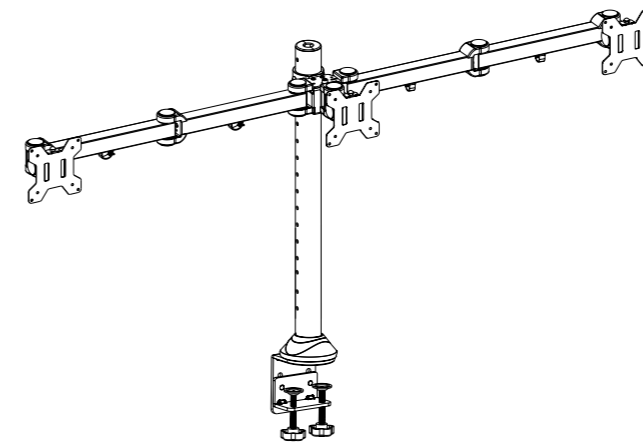

6 screens

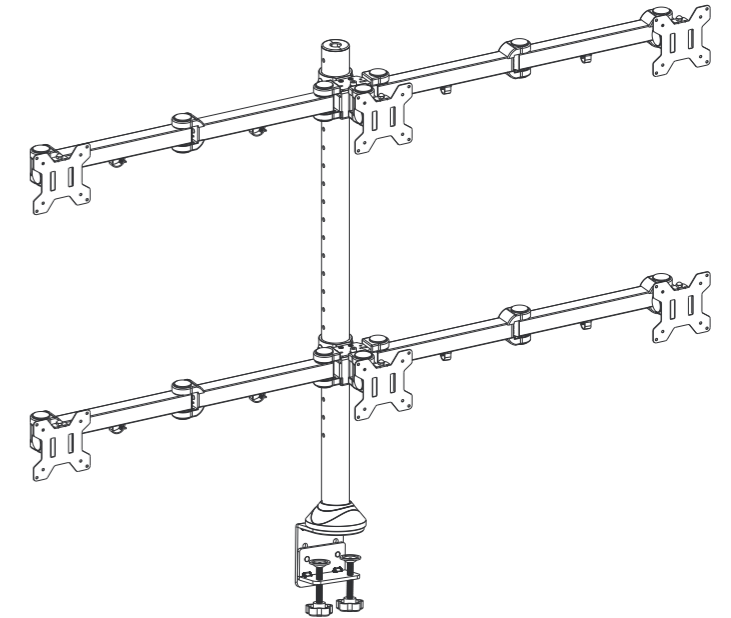



Technical details

- Supports up to six 10kg monitors up to 24" in screen size (maximum screen width 600mm)
- Ø48mm pole and extra heavy duty hinged support arms
- Removable VESA plates
- Desk edge clamp or through desk fixing included
- Black powder-coated steel
- Certified to: BS EN ISO 9241 Workplace Ergonomics, PP 045 Safety & Durability

Materials

Metal
Black (BK)

	CODE	DESCRIPTION	RSP (£)
	PMA323	Triple screen heavy duty monitor arm, 3 x 10kg capacity	325
	PMA326	Six screen heavy duty monitor arm, 6 x 10kg capacity	545

Levo

Dynamic monitor arm & twin rail



Levo offers the very latest in monitor arm design with a unique ratchet and clutch mechanism engineered to hold large screens securely, whilst being easy and smooth to adjust.

Simple to install, Levo is perfect for single or dual screens in agile working environments or with large touch screens at exhibitions or in reception areas.

Materials

Metal

- Black (BK)
- White (WH)
- Grey (SV)

Twin rail only available in black

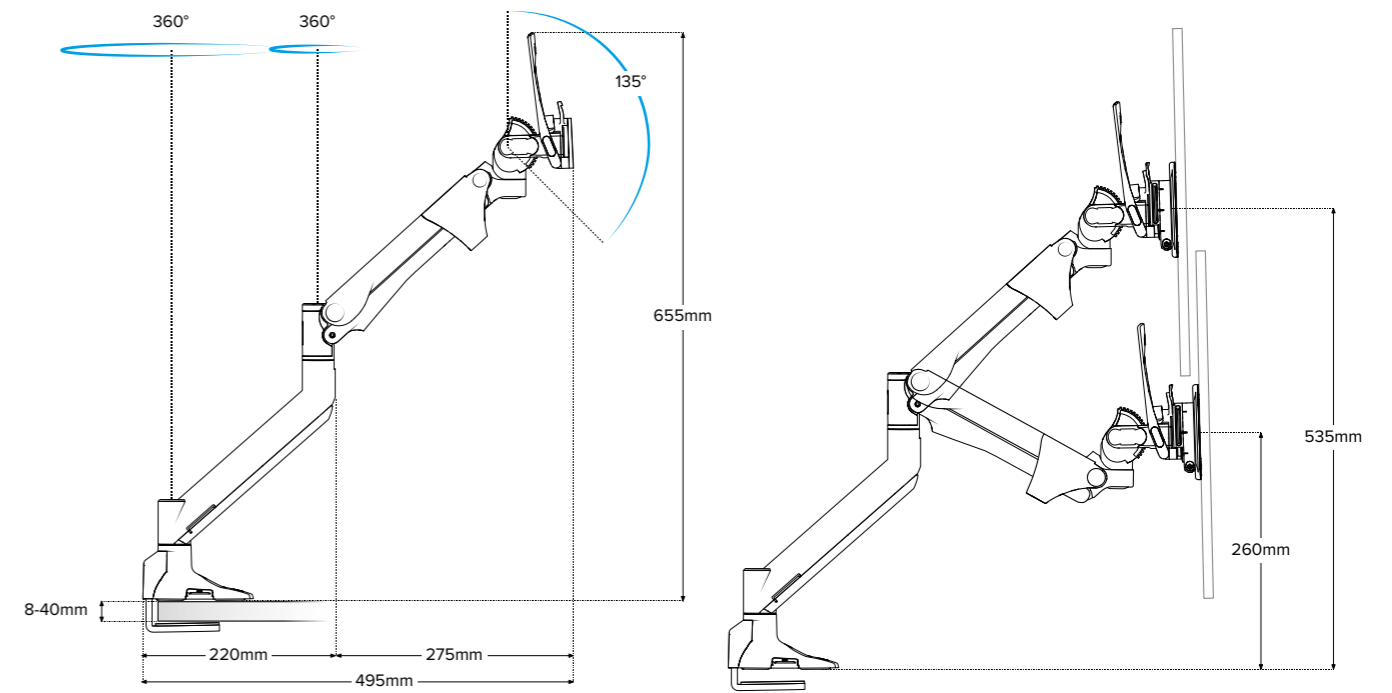

Technical details

Monitor arm

- Quick-release 75mm/100mm VESA mount with hand-turn screws
- Smooth gas lift for easy height adjustment
- Innovative ratchet tilt adjustment with safety clutch mechanism using easy to access lever
- One-touch easy position adjustment
- Tension adjustment indicator helps reduce project installation times
- Optional 180° rotation stop
- Integral high capacity cable management (4 cables)
- Desk-edge clamp and through-desk clamp included, tightened from above the desk for easy installation
- Flexible base design for through-desk cable management
- All tools included, stored neatly in the base
- Convert to laptop holder with universal VESA attachment

Twin rail attachment

- Quick-release mount
- Easy slide adjustment to position screens
- Optional handle aids rail tilt adjustment
- Supports 2 screens 1-4kg, up to 730mm max. screen width

	CODE	DESCRIPTION	RSP (£)
	GMA821	Levo gas lift monitor arm for single screen/monitor 10kg capacity	185
	TSR822	Levo twin rail attachment to convert single arm to dual screens/monitors 2 x 4kg capacity (8kg total) Available in Black only	100
	NBT101	Universal laptop holder attachment 10kg capacity	66

Boost

Desktop power modules



Type E
(French)
sockets
available



Beautifully stylish and incredibly compact, the Boost desktop module provides power exactly where you need it while using minimal space on your desk.

Boost is designed to appear subtle and unobtrusive at the rear of the desktop, available in white or black.

The modules include a choice of 1, 2 or 4 individually fused UK power sockets with a neon master switch, with the option of USB-A & USB-C fast charge sockets and RJ45 Cat6 data sockets. Mains power cables are available with a choice of 2, 3 or 5 metre length.

Technical details









- Type G (UK) individually fused or Type E (French) power sockets available, 250V/5A
- Neon master switch option
- Option of USB-A + USB-C fast charge and RJ45 data transfer ports.
- High quality aluminium casing
- 2 x desk edge fixing clamps
- 500mm power drop cable with GST 3-pole male connector with retaining clip
- Certified to BS 5733, CE marked
- 5 year warranty





Materials

Plastic / Aluminium*

Black (BK)
White (WH)

* Please note: 500mm drop cables match module colour. Starter cables and connector cables are black only. Please contact us for power and connector cables in white.

	CODE	DESCRIPTION	RSP (£)
	DPM-1P1N2C(A/C)	Desktop power module, 1 x Type G (UK) socket, 1 x USB-A + 1 x USB-C charge ports, with neon master switch <i>Power cable must be ordered</i>	110
	DPM-2P1N	Desktop power module, 2 x Type G (UK) sockets, with neon master switch <i>Power cable must be ordered</i>	73
	DPM-2P1N2C(A/C)	Desktop power module, 2 x Type G (UK) sockets, 1 x USB-A + 1 x USB-C charge ports, with neon master switch <i>Power cable must be ordered</i>	123
	DPM-2P(E)2C(A/C)	Desktop power module, 2 x Type E (French) sockets, 1 x USB-A + 1 x USB-C charge ports <i>Power cable must be ordered</i>	123
	DPM-2P1N2D	Desktop power module, 2 x Type G (UK) sockets, 2 x RJ45 data transfer ports, with neon master switch <i>Power / data cables must be ordered</i>	95
	DPM-2P1N2D2C(A/C)	Desktop power module, 2 x Type G (UK) sockets, 1 x USB-A + 1 x USB-C charge ports, 2 x RJ45 data transfer ports, with neon master switch <i>Power / data cables must be ordered</i>	145
	DPM-2P(E)2D2C(A/C)	Desktop power module, 2 x Type E (French) sockets, 1 x USB-A + 1 x USB-C charge ports, 2 x RJ45 data transfer ports <i>Power / data cables must be ordered</i>	145
	DPM-4P1N2C(A/C)	Desktop power module, 4 x Type G (UK) sockets, 1 x USB-A + 1 x USB-C charge ports, with neon master switch <i>Power cable must be ordered</i>	156

	CODE	DESCRIPTION	RSP (£)
	PL-UKWF/01	1m starter cable, mains to GST 3-pole female connector, black*	17
	PL-UKWF/02	2m starter cable, mains to GST 3-pole female connector, black*	18
	PL-UKWF/03	3m starter cable, mains to GST 3-pole female connector, black*	22
	PL-UKWF/04	4m starter cable, mains to GST 3-pole female connector, black*	27
	PL-UKWF/05	5m starter cable, mains to GST 3-pole female connector, black*	30
	PL-UKWF/06	6m starter cable, mains to GST 3-pole female connector, black*	40
	PL-UKWF/07	7m starter cable, mains to GST 3-pole female connector, black*	42
	PL-UKWF/08	8m starter cable, mains to GST 3-pole female connector, black*	46
	PL-UKWF/09	9m starter cable, mains to GST 3-pole female connector, black*	50
	PL-UKWF/10	10m starter cable, mains to GST 3-pole female connector, black*	55
	PL-EWF/02	Type E (French) 2m starter cable, mains to GST 3-pole female connector, black	16
	PL-EWF/03	Type E (French) 3m starter cable, mains to GST 3-pole female connector, black	19
	PL-WMWF/01	1m connector cable, GST 3-pole male to female connector, black	16
	PL-WMWF/02	2m connector cable, GST 3-pole male to female connector, black	19
	DL-CAT6/02-BK	2m Cat6 data network patch cable, black	8
	DL-CAT6/03-BK	3m Cat6 data network patch cable, black	11
	DL-CAT6/05-BK	5m Cat6 data network patch cable, black	16
	PS-1M2F-BK	GST splitter, 1 male in to 2 female out	24

Solo + Solo Plus

In-desk power modules



Type E
socket
available
with Solo

Solo: Simple. Convenient. Incredible value.

With a single UK power socket, USB Smart Charge socket and 2.5m mains power cable, Solo fits conveniently in a standard Ø80mm port hole and provides the perfect accessory to your desk.

Solo Plus offers the same compact simplicity of Solo with a single UK power socket and USB-A smart charge socket plus the addition of 2 x USB-C smart charge sockets - all in one Ø80mm module!

Choose from HDMI or Cat6 RJ45 data transfer inserts for both sides of the module or alternatively have them blank or leave empty for use as cable pass-throughs.

Secure Solo Plus in place with a choice of clamp-on collar or tab system for desk and tables where the collar won't fit.

Technical

SOLO PLUS

- Ø110mm x H65mm
Fits Ø80mm porthole
- 1 x Type G (UK) power socket
230V/13A/3000W
- 1 x USB-A smart charge socket
(QC 3.0 standard, 18W max)
- 2 x USB-C smart charge sockets
(PD standard, both 45W max)
- Option of 2 x data transfer inserts
(HDMI, RJ45, empty or blank)
- 500mm drop power cable with
GST 3-pole male connector
- Fully tested and certified to
BS5733, BS1363-2/A,
CE & UKCA marked
- 5 year warranty









SOLO









- Ø100mm x H80mm
Fits Ø80mm porthole
(Ø60mm without surround)
- 1 x Type G (UK) power socket
230V/13A/3000W
- Type E (French) power socket
230V/13A/3000W
- 1 x USB-A smart charge socket
(QC 3.0 standard, 12W max)
- 2.5m hardwired mains
power cable
- Fully tested and certified to
BS5733 & BS1363/A, CE marked
- 5 year warranty

Materials

Plastic*

- Black (BK)
- White (WH)

	CODE	DESCRIPTION	RSP (£)
	S1-1P3C(1A/2C)2B	Solo Plus Type G (UK) in-desk power module, 1 x USB-A + 2 x USB-C smart charge ports, 2 x Blank inserts, 500mm drop power cable with GST 3-pole male connector <i>Power cable must be ordered</i>	160
	S1-1P3C(1A/2C)2D	Solo Plus Type G (UK) in-desk power module, 1 x USB-A + 2 x USB-C smart charge ports, 2 x RJ45 data transfer ports, 500mm drop power cable with GST 3-pole male connector <i>Power / data cables must be ordered</i>	182
	S1-1P3C(1A/2C)2H	Solo Plus Type G (UK) in-desk power module, 1 x USB-A + 2 x USB-C smart charge ports, 2 x HDMI data transfer ports, 500mm drop power cable with GST 3-pole male connector <i>Power / data cables must be ordered</i>	182
	S1-1P3C(1A/2C)1B1D	Solo Plus Type G (UK) in-desk power module, 1 x USB-A + 2 x USB-C smart charge ports, 1 x Blank insert + 1 x RJ45 data transfer port, 500mm drop power cable with GST 3-pole male connector <i>Power / data cables must be ordered</i>	171
	S1-1P3C(1A/2C)1B1H	Solo Plus Type G (UK) in-desk power module, 1 x USB-A + 2 x USB-C smart charge ports, 1 x Blank insert + 1 x HDMI data transfer port, 500mm drop power cable with GST 3-pole male connector <i>Power / data cables must be ordered</i>	171
	S1-1P3C(1A/2C)1D1H	Solo Plus Type G (UK) in-desk power module, 1 x USB-A + 2 x USB-C smart charge ports, 1 x RJ45 + 1 x HDMI data transfer ports, 500mm drop power cable with GST 3-pole male connector <i>Power / data cables must be ordered</i>	182
	S1-1P3C(1A/2C)1B	Solo Plus Type G (UK) in-desk power module, 1 x USB-A + 2 x USB-C smart charge ports, 1 x Blank insert + 1 x Empty insert, 500mm drop power cable with GST 3-pole male connector <i>Power cable must be ordered</i>	156
	S1-1P3C(1A/2C)1D	Solo Plus Type G (UK) in-desk power module, 1 x USB-A + 2 x USB-C smart charge ports, 1 x RJ45 data transfer port + 1 x Empty insert, 500mm drop power cable with GST 3-pole male connector <i>Power / data cables must be ordered</i>	167
	S1-1P3C(1A/2C)1H	Solo Plus Type G (UK) in-desk power module, 1 x USB-A + 2 x USB-C smart charge ports, 1 x HDMI data transfer port + 1 x Empty insert, 500mm drop power cable with GST 3-pole male connector <i>Power / data cables must be ordered</i>	167

	CODE	DESCRIPTION	RSP (£)
	S1-1P3C(1A/2C)	Solo Plus Type G (UK) in-desk power module, 1 x USB-A + 2 x USB-C smart charge ports, 2 x Empty inserts, 500mm drop power cable with GST 3-pole male connector <i>Power cable must be ordered</i>	150
	S1-KS-H	Spare HDMI data transfer insert	15
	S1-KS-D	Spare RJ45 (Cat6) data transfer insert	15
	S1-KS-B	Spare blank data transfer insert	4
	S1-1P1C/025	Solo in-desk power module, with single Type G (UK) power socket, 1 x USB-A smart charge port, 2.5m hardwired power cable	103
	S1-1P(E)1C/025	Solo in-desk power module, with single Type E (French) power socket, 1 x USB-A smart charge port, 2.5m hardwired power cable	103
	PL-UKWF/01	1m starter cable, mains to GST 3-pole female connector, black*	17
	PL-UKWF/02	2m starter cable, mains to GST 3-pole female connector, black*	18
	PL-UKWF/03	3m starter cable, mains to GST 3-pole female connector, black*	22
	PL-UKWF/04	4m starter cable, mains to GST 3-pole female connector, black*	27
	PL-UKWF/05	5m starter cable, mains to GST 3-pole female connector, black*	30
	PL-UKWF/06	6m starter cable, mains to GST 3-pole female connector, black*	40
	PL-UKWF/07	7m starter cable, mains to GST 3-pole female connector, black*	42
	PL-UKWF/08	8m starter cable, mains to GST 3-pole female connector, black*	46
	PL-UKWF/09	9m starter cable, mains to GST 3-pole female connector, black*	50
	PL-UKWF/10	10m starter cable, mains to GST 3-pole female connector, black*	55
	PL-WMWF/01	1m connector cable, GST 3-pole male to female connector, black*	16
	PL-WMWF/02	2m connector cable, GST 3-pole male to female connector, black*	19
	HL-MM/02-BK	2m HDMI data cable, black	8
	HL-MM/03-BK	3m HDMI data cable, black	11
	HL-MM/05-BK	5m HDMI data cable, black	16
	DL-CAT6/02-BK	2m Cat6 data network patch cable, black	8
	DL-CAT6/03-BK	3m Cat6 data network patch cable, black	11
	DL-CAT6/05-BK	5m Cat6 data network patch cable, black	16
	PL-EWF/02	Type E (French) 2m starter cable, mains to GST 3-pole female connector, black*	16
	PL-EWF/03	Type E (French) 3m starter cable, mains to GST 3-pole female connector, black*	19
	PS-1M2F-BK	GST splitter, 1 male in to 2 female out	24

* 500mm drop cables match module colour. Separate power and data cables are black only. Please contact us for power / connector cables in white. Other starter and connector cable lengths are available on request.

Click

Hidden in-surface power module

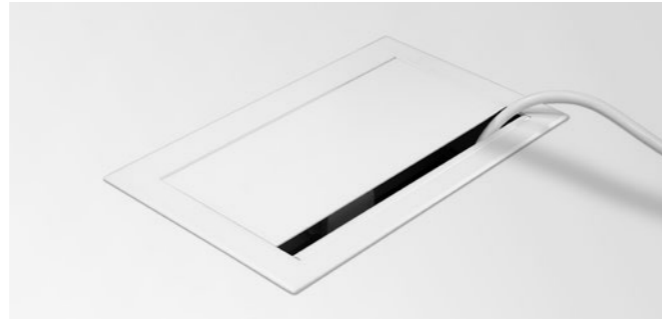
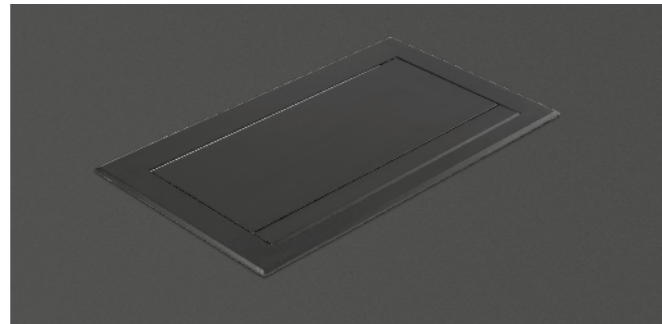

Click is an in-desk power module made with an all metal surround and lid. When closed the lid discretely hides any clutter while allowing cables to neatly pass onto the work surface through the sprung flap.







Simply press the lid to release and reveal the sockets. Click offers 2 Type G (UK) power sockets, USB-A and USB-C charge ports, RJ45 and HDMI data transfer ports.

Technical

- W290 x D174 x H90 mm
- 3mm surface impact
- 275 x 164mm cutout required
- 2 x 13A Type G (UK) sockets
- USB-A + USB-C charge ports, 5.0V/2.4A
- 1 x RJ45 data transfer port
- 1 x HDMI data transfer port
- Integrated GST 3-pole female connector
- 500mm drop power cable with GST 3-pole male connector
- Certified to BS1363/A, BS5733/A, CE & UKCA marked
- 5 year warranty

Materials

Plastic / metal*
Black (BK)
White (WH)

	CODE	DESCRIPTION	RSP (£)
	APM-2P1D2C(A/C)1H	In-desk power module, with 2 x Type G (UK) power sockets, 1 x USB-A + 1 x USB-C smart charge ports, 1 x RJ45 + 1 x HDMI data transfer ports, 275 x 164mm cutout required <i>Power / data cables must be ordered</i>	330
	PL-UKWF/01	1m starter cable, mains to GST 3-pole female connector, black*	17
	PL-UKWF/02	2m starter cable, mains to GST 3-pole female connector, black*	18
	PL-UKWF/03	3m starter cable, mains to GST 3-pole female connector, black*	22
	PL-UKWF/04	4m starter cable, mains to GST 3-pole female connector, black*	27
	PL-UKWF/05	5m starter cable, mains to GST 3-pole female connector, black*	30
	PL-UKWF/06	6m starter cable, mains to GST 3-pole female connector, black*	40
	PL-UKWF/07	7m starter cable, mains to GST 3-pole female connector, black*	42
	PL-UKWF/08	8m starter cable, mains to GST 3-pole female connector, black*	46
	PL-UKWF/09	9m starter cable, mains to GST 3-pole female connector, black*	50
	PL-UKWF/10	10m starter cable, mains to GST 3-pole female connector, black*	55
	PL-WMWF/01	1m connector cable, GST 3-pole male to female connector, black*	16
	PL-WMWF/02	2m connector cable, GST 3-pole male to female connector, black*	19
	HL-MM/02-BK	2m HDMI data cable, black	8
	HL-MM/03-BK	3m HDMI data cable, black	11
	HL-MM/05-BK	5m HDMI data cable, black	16
	DL-CAT6/02-BK	2m Cat6 data network patch cable, black	8
	DL-CAT6/03-BK	3m Cat6 data network patch cable, black	11
	DL-CAT6/05-BK	5m Cat6 data network patch cable, black	16
	PS-1M2F-BK	GST splitter, 1 male in to 2 female out	24

* 500mm drop cables match module colour. Separate power and data cables are black only. Please contact us for power / connector cables in white. Other starter and connector cable lengths are available on request.

Form

In-desk power modules



The Form power and comms module has an extraordinarily low profile which fits flush to tabletop.

As well as offering combinations of power, data transfer and USB charge ports, the UK power sockets can be orientated to service users on both sides of the table.

The thin profile also makes it suitable for panel mounting and soft furnishing.

Technical details

- Slimline bezel
- Fast installation
- Fire rated, BS 5733 certified
- PAT tested
- 13A Type G (UK power sockets)
- USB-C port is 45w power delivery
- Available with Type E (French) power sockets
- 500mm drop poer cable with GST 3-pole male connector
- Power cable included (mains to female GST 3-pole connector)
- Data cables (Cat6, HMDI) included (if applicable)
- Module height: 50mm

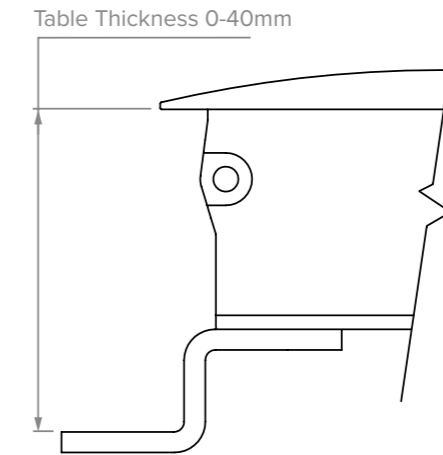

Materials

- Black / Black (BK)
- Grey / Anodised (SV)
- White / White (WH)

	CODE	DESCRIPTION	CABLE	RSP (£)
	FIM-2P/02	2 x Type G (UK) sockets,	2m	253
	FIM-2P/03	W155 x D73 mm cutout required	3m	258
	FIM-2P/05	All cables included	5m	266
	FIM-2P2C(A/C)/02	2 x Type G (UK) sockets, 1 x USB-A + 1 x USB-C charge ports,	2m	376
	FIM-2P2C(A/C)/03	W235 x D73 mm cutout required	3m	381
	FIM-2P2C(A/C)/05	All cables included	5m	389
	FIM-2P2D(C6)/02	2 x Type G (UK) sockets, 2 x RJ45 data transfer ports,	2m	337
	FIM-2P2D(C6)/03	W195 x D73 mm cutout required	3m	343
	FIM-2P2D(C6)/05	All cables included	5m	355
	FIM-2P2C(A/C)2D(C6)/02	2 x Type G (UK) sockets, 1 x USB-A + 1 x USB-C charge ports,	2m	464
	FIM-2P2C(A/C)2D(C6)/03	2 x RJ45 data transfer ports,	3m	470
	FIM-2P2C(A/C)2D(C6)/05	W275 x D73 mm cutout required	5m	482
	FIM-2P2C(A/C)1H/02	2 x Type G (UK) sockets, 1 x USB-A + 1 x USB-C charge ports,	2m	475
	FIM-2P2C(A/C)1H/03	1 x HDMI data transfer port,	3m	502
	FIM-2P2C(A/C)1H/05	W275 x D73 mm cutout required	5m	557
	FIM-2P2D(C6)1H/02	2 x Type G (UK) sockets, 2 x RJ45 data transfer ports,	2m	435
	FIM-2P2D(C6)1H/03	1 x HDMI data transfer port,	3m	464
	FIM-2P2D(C6)1H/05	W235 x D73 mm cutout required	5m	523
	FIM-2P2C(A/C)2D(C6)1H/02	2 x Type G (UK) sockets, 1 x USB-A + 1 x USB-C charge ports,	2m	579
	FIM-2P2C(A/C)2D(C6)1H/03	2 x RJ45 data transfer ports, 1 x HDMI data transfer port	3m	612
	FIM-2P2C(A/C)2D(C6)1H/05	W315 x D73 mm cutout required	5m	679
		All cables included		

Power unit

In-desk power modules



Narbutas power units are designed to fit cutouts on corresponding Narbutas desktops and tabletops, including: My Space, Nova, Nova Wood, Round and T-Easy, and Motion.

These units are not suitable for: Nova Wood Multipurpose, Nova Wood Meeting, Nova Slide, Air, Optima, Plana, Jazz Meeting, Domino, Silent Room, Media, Arcipelago Wood.





Technical details







- Available in Type G (UK), Type F (EU) and Type E (FR), power socket standards
- W317 x D119 x H45 mm

Materials

Metal surround

- White (E)
- Black (A)
- Grey (M)
- Dark Grey (T1)
- Deep Bronze (S1)
- Dusty Rose (ME1)
- Avocado Green (ME2)

	CODE	DESCRIPTION	RSP (£)
	ZZZ359	Power unit (3 x UK power sockets) with metal frame, for rectangular desktops with cutouts	399
	ZZZ360	Power unit (2 x UK power sockets and 1 x RJ45 data socket) with metal frame, for rectangular desktops with cutouts	450
	ZZZ361	Power unit (2 x UK power sockets and 1 x USB-A & USB-C fast charger) with metal frame, for rectangular desktops with cutouts	804
	ZZZ362	Power unit (1 x UK power sockets, USB-A & USB-C fast charger, and 1 x RJ45 data socket) with metal frame, for rectangular desktops with cutouts	931
	ZZZ351	Distributor block, flat GST18i3 (1 IN, 2 OUT)	117

	CODE	DESCRIPTION	RSP (£)
	PL-UKWF/02	2m starter cable, mains to GST 3-pole female connector, black	18
	PL-UKWF/03	3m starter cable, mains to GST 3-pole female connector, black	22
	PL-UKWF/05	5m starter cable, mains to GST 3-pole female connector, black	30
	PL-WMWF/01	1m connector cable, GST 3-pole male to female connector, black	16
	PL-WMWF/02	2m connector cable, GST 3-pole male to female connector, black	19
	DL-CAT6/02-BK	2m Cat6 data network patch cable, black	8
	DL-CAT6/03-BK	3m Cat6 data network patch cable, black	11
	DL-CAT6/05-BK	5m Cat6 data network patch cable, black	16

Other starter and connector cable lengths are available on request.

Powerlink

Underdesk power modules



Type E
(French)
sockets
available



These simple but robust power modules can be installed in cable trays or fixed to the underside of the desk using the brackets or velcro pads provided.











With high quality aluminium alloy casing, solid construction and sleek appearance, Powerlink offers incredible value for money at a very affordable price.





Powerlink modules can be linked to other underdesk or desktop power modules, including Boost, using connector cables with a maximum of six power sockets in one series.

Powerlink comes as a silver alloy case with black plastic insert.

Technical details

- Type G (UK) fused or Type E (French) power sockets
- 250V/5A
- Optional neon master switch
- Male and female GST 3-pole connectors (1 x male connector only on six socket version)
- Fixing brackets (screws) and hook & loop pads
- 250mm trailing earth wire
- Champagne alloy casing with black plastic insert
- Fully tested and certified to BS 5733, CE marked
- 5 year warranty

	CODE	DESCRIPTION	RSP (£)
	UPMA-2P-SV	Under-desk power module, 2 x Type G (UK) sockets <i>Power cable must be ordered</i>	32
	UPMA-2P1N-SV	Under-desk power module, 2 x Type G (UK) sockets, with neon master switch <i>Power cable must be ordered</i>	35
	UPMA-2P(E)-SV	Type E (French) under-desk power module, 2 x Type E (French) sockets <i>Power cable must be ordered</i>	32
	UPMA-3P-SV	Under-desk power module, 3 x Type G (UK) sockets <i>Power cable must be ordered</i>	34
	UPMA-3P(E)-SV	Type E (French) under-desk power module, 3 x Type E (French) sockets <i>Power cable must be ordered</i>	34
	UPMA-4P-SV	Under-desk power module, 4 x Type G (UK) sockets <i>Power cable must be ordered</i>	35
	UPMA-4P1N-SV	Under-desk power module, 4 x Type G (UK) sockets, with neon master switch <i>Power cable must be ordered</i>	40
	UPMA-4P(E)-SV	Type E (French) under-desk power module, 4 x Type E (French) sockets <i>Power cable must be ordered</i>	35
	UPMA-6P-SV	Under-desk power module, 6 x Type G (UK) sockets <i>Power cable must be ordered</i>	49
	UPMA-6P(E)-SV	Type E (French) under-desk power module, 6 x Type E (French) sockets <i>Power cable must be ordered</i>	49

	CODE	DESCRIPTION	RSP (£)
	PL-UKWF/01	1m starter cable, mains to GST 3-pole female connector, black*	17
	PL-UKWF/02	2m starter cable, mains to GST 3-pole female connector, black*	18
	PL-UKWF/03	3m starter cable, mains to GST 3-pole female connector, black*	22
	PL-UKWF/04	4m starter cable, mains to GST 3-pole female connector, black*	27
	PL-UKWF/05	5m starter cable, mains to GST 3-pole female connector, black*	30
	PL-UKWF/06	6m starter cable, mains to GST 3-pole female connector, black*	40
	PL-UKWF/07	7m starter cable, mains to GST 3-pole female connector, black*	42
	PL-UKWF/08	8m starter cable, mains to GST 3-pole female connector, black*	46
	PL-UKWF/09	9m starter cable, mains to GST 3-pole female connector, black*	50
	PL-UKWF/10	10m starter cable, mains to GST 3-pole female connector, black*	55
	PL-EWF/02	Type E (French) 2m starter cable, mains to GST 3-pole female connector, black	16
	PL-EWF/03	Type E (French) 3m starter cable, mains to GST 3-pole female connector, black	19
	PL-WMWF/01	1m connector cable, GST 3-pole male to female connector, black	16
	PL-WMWF/02	2m connector cable, GST 3-pole male to female connector, black	19
	PS-1M2F-BK	GST splitter, 1 male in to 2 female out	24

CPU holders

for most form factors



Technical details

T1 & T2







- Spring-loaded pin to adjust height easily
- Security bars prevent CPU falling from holder
- Mount to desktop or side panel
- Optional slide and turn kit
- Optional desk beam clearance kit

T3

- Easy adjustment with straps and side release buckles
- Includes desk beam clearance kit
- Optional horizontal mounting kit

S1

- › Designed for thin client, adjustable for other sizes
- Ideal for Apple Mac Mini®
- Adjustable security strap with side release buckle
- Mount to desktop, side panel, VESA or monitor arm pole

	CODE	DESCRIPTION	RSP (£)
	CHF2208	T1 CPU holder, designed for mid tower CPUs, adjustable for other sizes, spring-loaded pin, security bars, mount to desktop or side panel, available in Black (BK), Grey (SV) and White (WH) Capacities: W35-252 x D140-490 x H333-564 mm	105
	CHF1104	T2 CPU holder, designed for mini tower or SFF CPUs, adjustable for other sizes, spring-loaded pin, security bars, mount to desktop or side panel, available in Black (BK), Grey (SV) and White (WH) Capacities: W35-110 x D140-300 x H213-360 mm	72
	CHUST	Slide & turn kit for T1 & T2 CPU holders, includes desk beam clearance kit (CHSP), available in Black (BK), Grey (SV) and White (WH)	55
	CHSP	Desk beam clearance kit for T1 & T2 CPU holders, available in Black (BK), Grey (SV) and White (WH)	9
	CHF2504	T3 universal CPU holder, designed for mini or mid tower CPUs, adjustable for other sizes, includes desk beam clearance kit, available in Black (BK) Capacity: Max. strap circumference 1190mm x Min. height 140mm	50
	CHFHMK	Optional T3 horizontal mounting kit, for mounting CPU horizontally under desktop, available in Black (BK)	22
	CHV1002	S1 CPU holder, designed for thin client, adjustable for other sizes, adjustable security strap, mount to desktop, side panel, VESA or monitor arm pole (compatible with Kardo, Duro and Levo monitor arms), available in Black (BK), Grey (SV) and White (WH) Capacity: Max. strap circumference 700mm x D25-63	39

Cable management

Spines + Socks + Ducts + Clips + Ports + Trays + Baskets



Linx cable spine

Designed with strength, flexibility and ease of installation in mind, Linx offers the latest developments in superior cable management. The unique 'twist not pull' linking system ensures the vertebrae will never pull apart under tension, but will detach very easily when twisted sideways. This ensures that Linx never comes apart while in use, but remains incredibly easy to extend and manipulate when needed. Choose from different lengths for fixed height or sit/stand desks or without the base for use between cable trays on sit/stand benches.

Linx magnetic limpet

The Linx Limpet makes installation quick and easy, fixing the spine to cable trays or desk frame with a magnet. The spine can be easily relocated if required.

- Alternative multipurpose fixing clip will mount to cable tray, wire basket or desktop
- Large weighted stable base with dual cable exits
- Dual cable compartments 30mm x 25mm

	CODE	DESCRIPTION	WIDTH	DEPTH	HEIGHT	RSP (£)
	VCS4/SDL	Magnetic Linx cable spine for standard desk - 20 vertebrae, weighted base, available in White (WH), Light Grey (SV) or Black (BK) plastic	65	35	800	57
	VCS4/SD	Linx cable spine for standard desk with fixing clip - 20 vertebrae, weighted base, available in White (WH), Light Grey (SV) or Black (BK) plastic	65	35	800	45
	VCS4/HAL	Magnetic Linx cable spine for sit/stand desk - 33 vertebrae, weighted base, available in White (WH), Light Grey (SV) or Black (BK) plastic	65	35	1300	74
	VCS4/HA	Linx cable spine for sit/stand desk with fixing clip	65	35	1300	62
	VCS4/HBL	Magnetic Linx cable spines for Alto 2 back-to-back sit/stand desk (incl. central cable tray) - 66 vertebrae, weighted base, available in White (WH), Light Grey (SV) or Black (BK) plastic				164
	VCS4/HB	Linx cable spines for Alto 2 back-to-back sit/stand desk (incl. central cable tray) with fixing clips				106
	VCS4/TTL	Magnetic Linx cable spine for tray-to-tray - 33 vertebrae, available in White (WH), Light Grey (SV) or Black (BK) plastic (no base)	65	35	1280	66
	VCS4/TT	Linx cable spine for tray-to-tray with fixing clips - 33 vertebrae, available in White (WH), Light Grey (SV) or Black (BK) plastic (no base)	65	35	1280	42
	VCS2	Fabric cable wrap sock (H657mm) with adjustable strap for small height adjustments, internal straps accommodate cables up to approx. 2.5cm ² in total, available in White (WH), Grey (SV) or Black (BK)	Ø70	-	720-820	50
	DNZ014	Magnetic cable duct, attaches to desk/table leg, available in White (E), Grey (M), Black (A) and Dark Grey (T1) metal	43	22	600	73
	DQZ001	3 cable clips (White plastic), for fitting to Nova frames/legs	-	-	-	22
	DQZ005	5 cable clips (White plastic), for fitting to Nova frames/legs	-	-	-	28











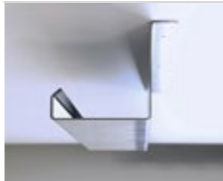

Untidy power and data cables are unsightly, make cleaning difficult and can pose a safety risk. Use of a cable tray underneath the desk helps to keep cables neat and tidy and the workspace clear. The range of simple but strong steel cable trays is designed to suit various desk sizes and arrangements. Steel wire cable baskets will hinge down on brackets for easy access during installation of cables.

Materials

Metal
 Black (BK)
 White (WH)
 Grey (SV)
 Dark Grey (AN)

Steel wire baskets are galvanised finish only

	CODE	DESCRIPTION	WIDTH	DEPTH	HEIGHT	RSP (£)
	CTD085	Desktop fix cable tray for W1200mm desk	850	100	125	97
	CTD105	Desktop fix cable tray for W1400mm desk	1050	100	125	102
	CTD125	Desktop fix cable tray for W1600mm desk	1250	100	125	106
	CTD145	Desktop fix cable tray for W1800mm desk	1450	100	125	124
	CTM085	Modesty panel fix cable tray for W1200mm desk	850	100	50	84
	CTM105	Modesty panel fix cable tray for W1400mm desk	1050	100	50	88
	CTM125	Modesty panel fix cable tray for W1600mm desk	1250	100	50	106
	CTM145	Modesty panel fix cable tray for W1800mm desk	1450	100	50	116
	CTS110	Shared desktop fix cable tray for W1200mm or W1400mm back-to-back bench desk	1100	110	130	86
	CTS140	Shared desktop fix cable tray for W1600mm or W1800mm back-to-back bench desk	1400	110	130	97
	CTW110	Extra wide desktop fix shared cable tray for W1200mm or W1400mm back-to-back bench desk	1100	430	130	134
	CTW140	Extra wide desktop fix shared cable tray for W1600mm or W1800mm back-to-back bench desk	1400	430	130	156
	CTWH110	Sliding desktop shared cable tray for W1400mm back-to-back bench desk, hooks onto frame	1100	430	130	142
	CTWH140	Sliding desktop shared cable tray for W1600mm back-to-back bench desk, hooks onto frame	1400	430	130	173
	MCB-0615-GB	Narrow cable basket for W800mm or W1000mm with desktop fixing brackets (2 pcs.)	600	150	50	49
	MCB-1015-GB	Narrow cable basket for W1200mm or W1400mm with desktop fixing brackets (2 pcs.)	1000	150	50	60
	MCB-1415-GB	Narrow cable basket for W1600mm or W1800mm with desktop fixing brackets (2 pcs.)	1400	150	50	70
	MCB-0630-GB	Wide cable basket for W800mm or W1000mm with desktop fixing brackets (3 pcs.)	600	300	50	67
	MCB-1030-GB	Wide cable basket for W1200mm or W1400mm with desktop fixing brackets (3 pcs.)	1000	300	50	82
	MCB-1430-GB	Wide cable basket for W1600mm or W1800mm with desktop fixing brackets (3 pcs.)	1400	300	50	95

	Black (A)	White (E)	Grey (M)	Dark Grey (T1)			
	CODE	DESCRIPTION	WIDTH	DEPTH	HEIGHT	RSP (£)	
	DNZ003	Desktop fix cable tray	360	180	110	66	
	DNZ004	Desktop fix cable tray	1080	180	110	122	
	DZZ081	Desktop fix cable tray for W800mm desk	430	75	90	51	
	DZZ101	Desktop fix cable tray for W1000 mm desk	630	75	90	71	
	DNZ019	Desktop fix cable tray	500	100	110	76	
	DNZ020		1100	100	110	109	
	DNZ005	Shared desktop fix cable tray for Nova/Nova Wood back-to-back bench desks	900	435	130	243	
	DNZ007		1300	435	130	302	
	DNZ008		1500	435	130	336	
	DNZ021	Shared desktop fix cable tray for Nova/Nova Wood back-to-back bench desks	500	380	110	116	
	DNZ022		1100	380	110	168	
	DNZ024	Cable tray for single W1400mm Nova desk with sliding top <i>Not compatible with A-frame desks</i>	1316	146	96	150	
	DNZ025	Cable tray for single W1600mm Nova desk with sliding top <i>Not compatible with A-frame desks</i>	1516	146	96	165	
	DZZ082	Modesty panel fix cable tray for W800mm desk	430	70	50	51	
	DZZ102	Modesty panel fix cable tray for W1000mm desk	630	70	50	65	
	ZZZ022	Round cable port, available in White, Black or Grey (plastic)	Ø80	-	-	13	
	ZZZ023	3 cable clips (Black plastic)	-	-	-	28	
	DEZ003	5 cable clips for wire management (Light Grey plastic)	-	-	-	28	
	ZNZ010	Cable port insert (flap) for 300 x 112 cut-out, available in White (E), Grey (M), Black (A) and Dark Grey (T1) metal	320	130	25	94	

Sit-stand mats

Anti-fatigue mats



Comfort Spot mats

Anti-fatigue mats reduce swelling of the legs and decrease fatigue by improving circulation.

Comfort Spot's elasticated and breathable cellular structure retains heat and it can be easily cleaned with a brush, vacuumed or washed with water. It comes with a handy hanging clip, compatible with any desktop.

Materials



Dark Grey

	CODE	DESCRIPTION	WIDTH	DEPTH	HEIGHT	RSP (£)
	AFMCS-DG	Comfort Spot anti-fatigue mat, includes hanging clip (Dark Grey fabric)	640	460	30	176

Coat racks

Metal coat stands





	CODE	DESCRIPTION	WIDTH	DEPTH	HEIGHT	RSP (€)
	ZZZ138	Bubble coat rack with umbrella holder ring (metal stand and plastic components) Available in Black (A)	Ø400	-	1730	158
	ZZZ139	Sun coat rack with umbrella holder ring (metal stand and plastic components) Available in Grey (M)	Ø400	-	1730	190
	ZZZ137	UFO coat rack with umbrella holder ring (metal stand and plastic components) Available in White (E) or Grey (M)	Ø400	-	1750	343

Drawers

Felt lined metal drawers



			G1: Era*			G2: Lucia*			G3: Velito Presto / Synergy*		
	CODE	DESCRIPTION	WIDTH	DEPTH	HEIGHT	G1 (€)	G2 (€)	G3 (€)			
	DZZ001	Felt lined metal underdesk drawer with lock Available in Black (A), White (E) or Grey (M)	584	290	50	312	325	338			
	DZZ002	Felt lined metal underdesk drawer with lock Available in Black (A), White (E) or Grey (M)	585	250	50	328	341	354			

Finishes & Fabrics



Finishes

Samples of all finishes are available on request.

MFC (melamine)

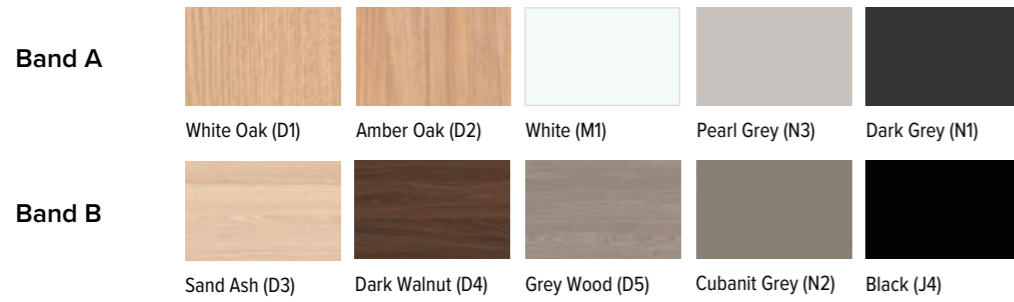

Veneer

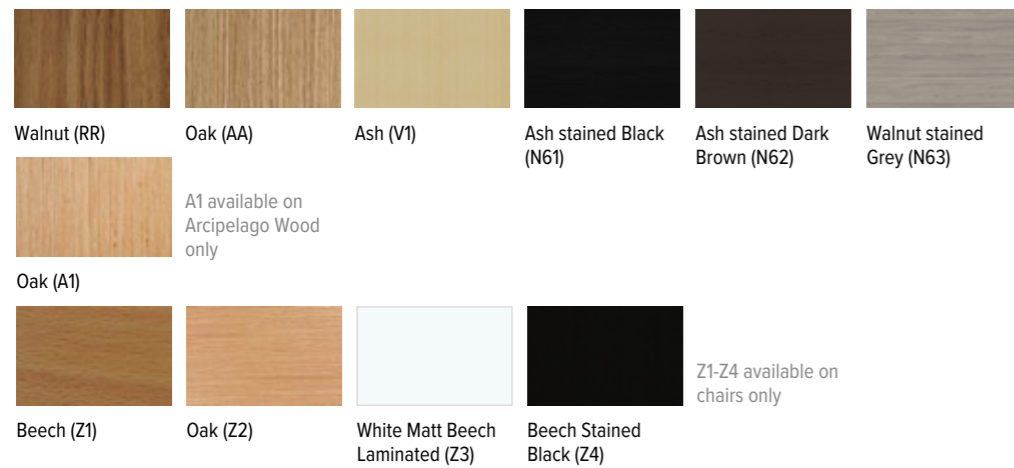

Solid Wood



HPL

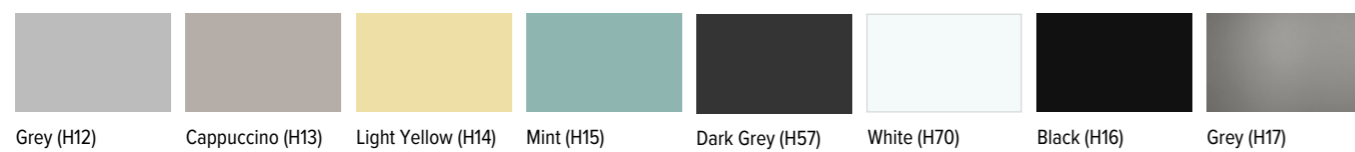

HPL Fenix

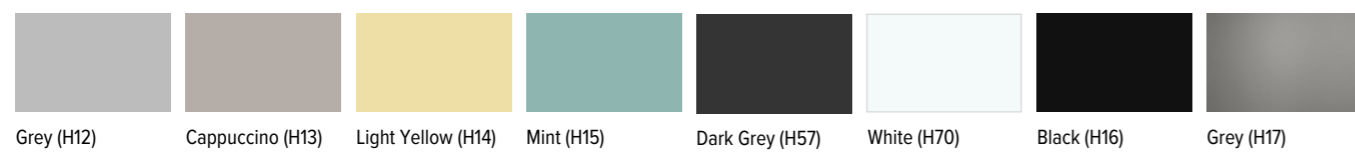

Metal

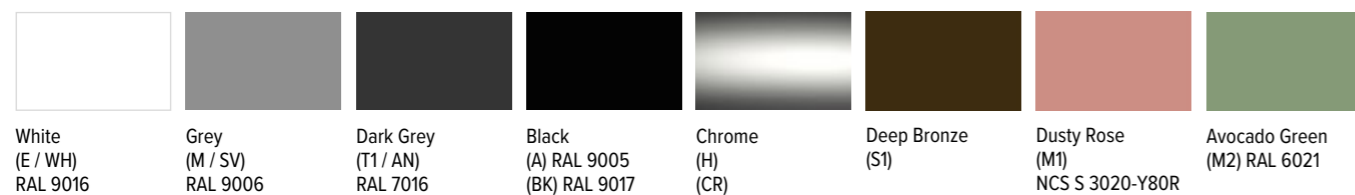

Plastic (Narbutas)



Plastic (Formetiq)

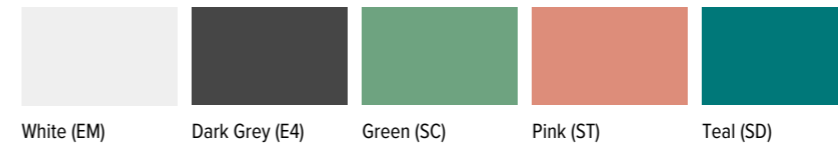

Plexiglas®

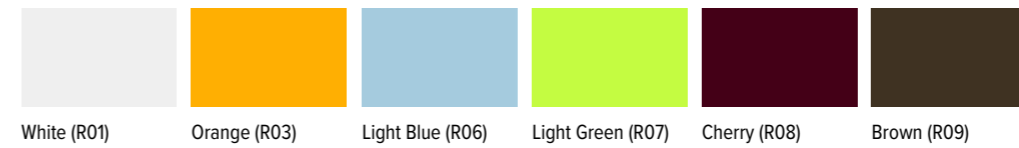

Perspex® Frost



Samples and alternative Perspex® colours / finishes are available on request.

Finishes comparison

	Whitened Oak (D1)	Amber Oak (D2)	White (M1)	Dark Grey (N1)	Pearl Grey (N3)	Black (J4)	White / Amber Oak Edge (M1D2)	Sand Ash (D3)	Dark Walnut (D4)	Grey Wood (D5)	Cubanit Grey (N2)	Grey (H12)	Cappuccino (H13)	Dark Grey (H57)	Light Yellow (H14)	Mint (H15)	White (H70)	Glossy White (H71)	White / Black Edge (H70B01)	White / White Edge (H70B02)	
	MFC											HPL									
Air Desks & Storage	•	•	•	•	•	•	•	•	•	•	•										
Air Tables	•	•	•	•	•	•	•	•	•	•	•										
Air Executive Tables	•	•	•		•			•	•	•	•										
Alto Sit/Stand Desks	•	•	•	•	•	•		•	•	•	•										
Amber Tables	•	•	•	•	•	•		•	•	•	•										
Arqus Executive																					
Boxi Storage	•	•	•	•	•	•	•	•	•	•	•	•	•	•	•	•					
Choice Lockers	•	•	•	•	•	•	•	•	•	•	•	•	•	•	•	•					
Choice Storage	•	•	•	•	•	•	•	•	•	•	•										
Domino Reception	•	•	•	•	•	•	•	•	•	•	•										
Forum Tables	•	•	•	•	•	•	•	•	•	•	•										
Ice Reception	•	•	•	•	•	•	•	•	•	•	•										
Light High Tables	•	•	•	•	•	•	•	•	•	•	•										
Media Walls	•	•	•	•	•	•	•	•	•	•	•										
Mobi Tables	•	•	•	•	•	•	•	•	•	•	•										
Motion Desks	•	•	•	•	•	•	•	•	•	•	•										
Motion Executive	•	•	•	•	•	•	•	•	•	•	•					•					
Move & Lead Desks / Storage						•															
Nova Desks / Modesty Panels	•	•	•	•	•	•	•	•	•	•	•										
Nova Tables	•	•	•	•	•	•	•	•	•	•	•										
Nova Pedestals	•	•	•	•	•	•	•	•	•	•	•										
Nova Reception	•	•	•	•	•	•	•	•	•	•	•										
Nova Storage	•	•	•	•	•	•	•	•	•	•	•										
Nova Wood Desks / Tables	•	•	•	•	•	•	•	•	•	•	•							•	•		
Nova Executive Desks	•	•	•	•	•	•	•	•	•	•	•										
Nova Executive Storage	•	•	•	•	•	•	•	•	•	•	•										
Novus Tables																					
Optima Desks	•	•	•	•	•	•	•	•	•	•	•										
Optima Storage & Pedestals	•	•	•	•	•	•	•	•	•	•	•										
Optima Tables	•	•	•	•	•	•	•	•	•	•	•										
Opto Tables	•	•	•		•	•	•	•	•	•	•										
Plana Desks & Tables	•	•	•	•	•	•	•	•	•	•	•										
Plana Storage	•	•	•	•	•	•	•	•	•	•	•										
Round Desks & Workstations		•	•	•	•	•	•	•	•	•	•										
Silent Room Booths	•	•	•	•	•	•	•	•	•	•	•										
Sito Tables	•	•	•	•	•	•	•	•	•	•	•										
T-Easy Desks / Tables	•	•	•	•	•	•	•	•	•	•	•										
Tera Reception	•	•	•	•	•	•	•	•	•	•	•	•	•	•	•	•					
Uni Plus Storage	•	•	•	•	•	•	•	•	•	•	•										
Uni Storage	•	•	•	•	•	•	•	•	•	•	•										
WorkLab	•	•	•	•	•	•	•	•	•	•	•										

	Black (H16)	Grey (H17)	Black with Black Edge (H16B01)	Grey with Grey Edge (H17B03)	Walnut (RK)	Oak (AA)	Ash (V1)	Ash stained Black (N61)	Ash stained Dark Brown (N62)	Walnut stained Grey (N63)	Ash stained Light Grey (W2)	Ash stained Black (W3)	White (E)	Dark Grey (T1)	Grey (M)	Black (A)	Deep Bronze (S1)	Chrome (H)	Dusty Rose (M1)	Avocado Green (M2)	
	HPL Fenix				Veneer					Wood	Metal										
Air Desks & Storage													•	•	•						
Air Tables					•	•	•	•	•	•			•	•	•				•		
Air Executive Tables					•	•	•						•	•	•				•		
Alto Sit/Stand Desks													•	•	•						
Amber Tables																					
Arqus Executive					•	•	•	•	•	•											
Boxi Storage													•	•	•	•					
Choice Lockers						•							•	•	•	•	•	•	•	•	•
Choice Storage					•	•	•						•	•	•	•					
Domino Reception					•	•	•	•	•	•											
Forum Tables													•	•	•	•					
Ice Reception					•	•	•	•	•	•											
Light High Tables													•	•	•						
Media Walls													•	•	•						
Mobi Tables					•	•	•	•	•	•			•	•	•						
Motion Desks													•	•	•						
Motion Executive	•	•			•	•	•	•	•	•			•	•	•						
Move & Lead Desks / Storage				•	•	•	•	•	•	•											
Nova Desks / Modesty Panels													•	•	•	•					
Nova Tables					•	•	•	•	•	•			•	•	•	•					
Nova Pedestals					•	•	•	•	•	•			•	•	•	•					
Nova Reception					•	•	•	•	•	•			•	•	•	•					
Nova Storage					•	•	•	•	•	•			•	•	•	•					
Nova Wood Desks / Tables													•	•	•	•					
Nova Executive Desks					•	•	•	•	•	•			•	•	•	•					
Nova Executive Storage					•	•	•	•	•	•			•	•	•	•					
Novus Tables					•	•	•						•	•	•						
Optima Desks					•	•	•	•	•	•			•	•	•						
Optima Storage & Pedestals					•	•	•	•	•	•			•	•	•	•					
Optima Tables					•	•	•	•	•	•			•	•	•						
Opto Tables					•	•	•	•	•	•			•	•	•						
Plana Desks & Tables					•	•	•	•	•	•			•	•	•	•	•	•	•		
Plana Storage					•	•	•	•	•	•			•	•	•	•					
Round Desks & Workstations													•	•	•	•					
Silent Room Booths																		•			
Sito Tables													•	•	•				•		
T-Easy Desks / Tables													•	•	•	•					
Tera Reception													•	•							
Uni Plus Storage													•	•	•	•					
Uni Storage													•	•	•	•					
WorkLab													•	•	•	•	•	•	•	•	•

Fabrics

The fabrics which adorn our products are used in a vast array of commercial interiors, education, healthcare and retail spaces. We work with manufacturers like Camira to bring you the highest quality fabrics and finishes for use with our products so you can release your inner creativity with an array of colours and styles. These fabrics are tried, tested, certified to be safe and produce long lasting, comfortable and beautiful results which bring colour, design and personality to interior workspaces.

Micro Mesh (MM)



GM Mesh

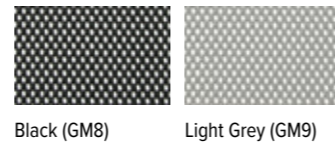

Knitted Mesh (KM)

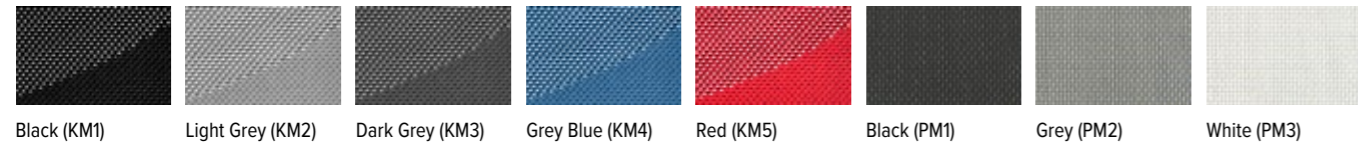

PM Mesh

RM Mesh

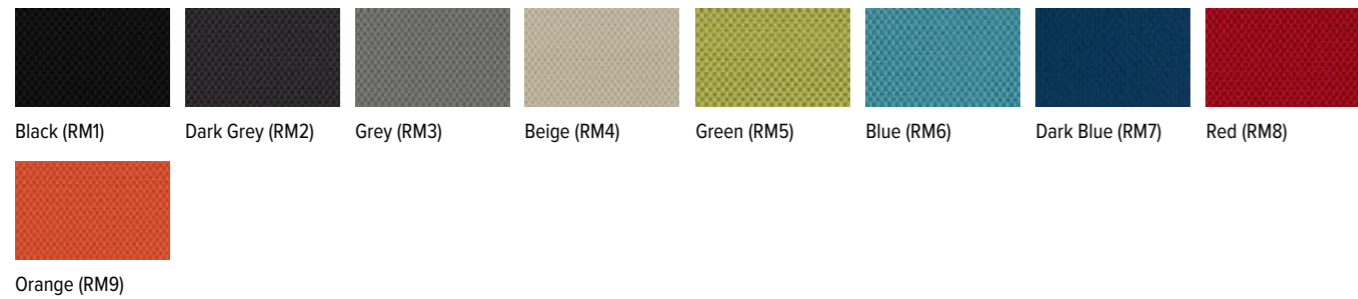

PET Felt



Audėjas Berta Polyester

Code in grey is Audėjas reference

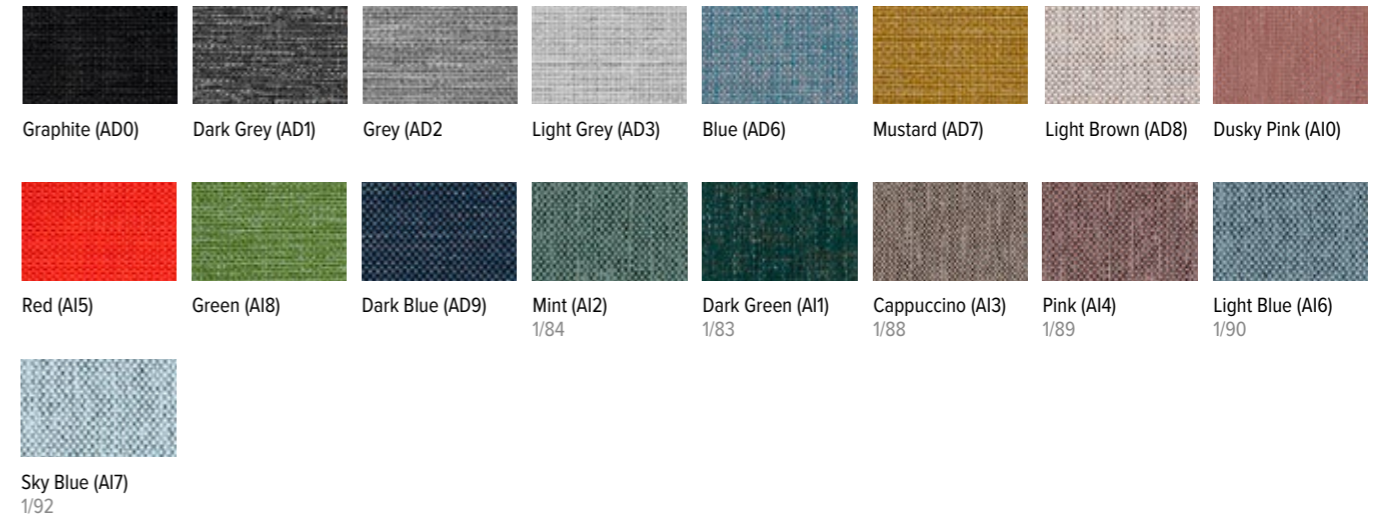

Gabriel® Step/Step Melange Polyester

Code in grey is Gabriel's dye colour reference, which is the same regardless of fabric type.

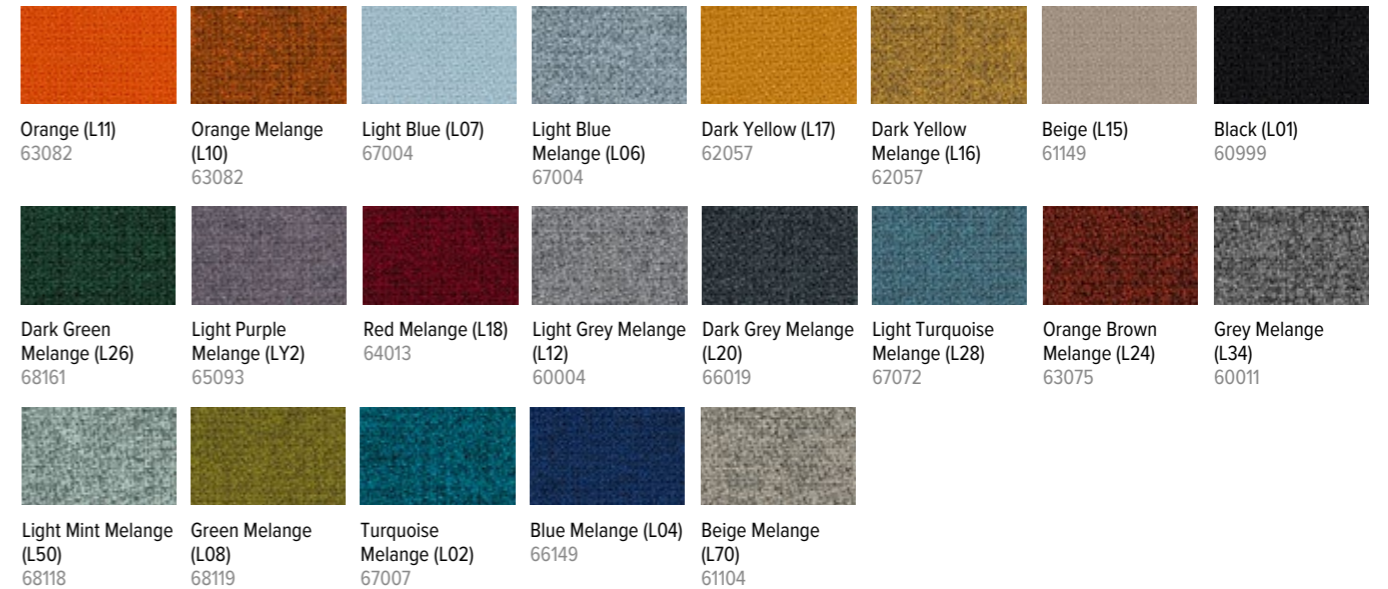

Camira Era* Polyester

Code in grey is Camira reference



* Narbutas products are available in every colour from this fabric range. Fabrics and shades not featured above will have a longer production time. Colours are a printed representation and may vary to actual finish.

* Narbutas products are available in every colour from this fabric range. Fabrics and shades not featured above will have a longer production time. Colours are a printed representation and may vary to actual finish.

Camira Lucia* Polyester

Code in grey is Camira reference.

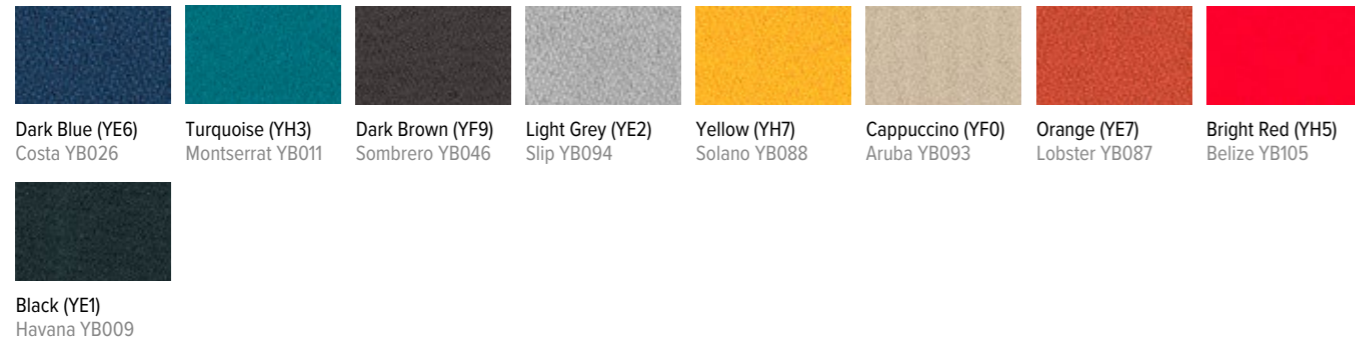

Fidivi Bondai Polyester

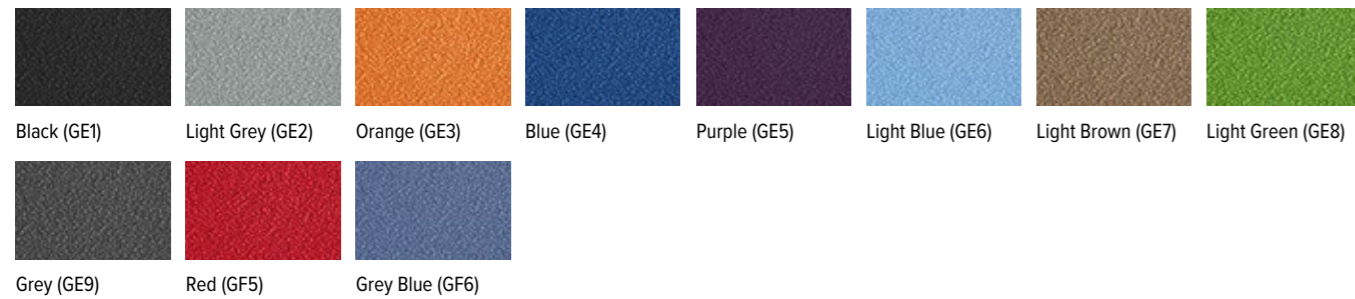

Camira Xtreme* Recycled Polyester

Code in grey is Camira reference

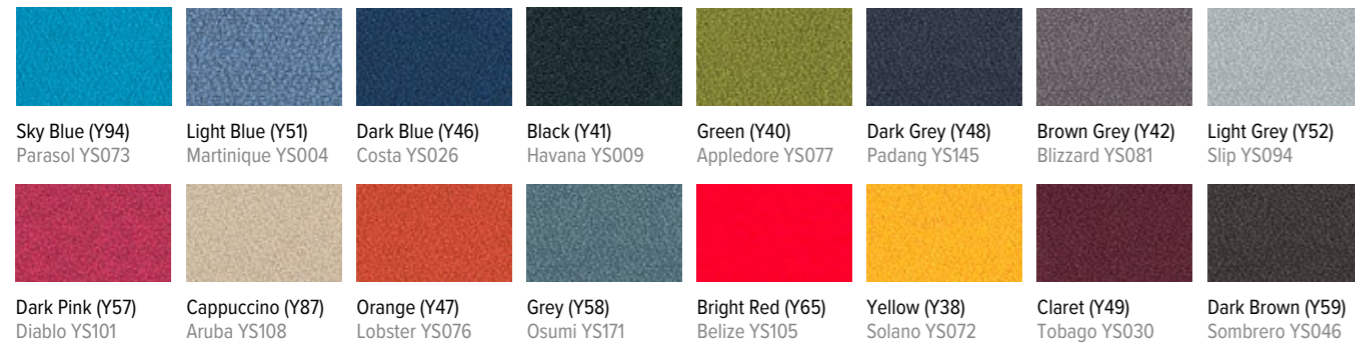

Camira Blazer Lite Polyester



Gabriel® Cyber Recycled Polyester

Code in grey is Gabriel reference

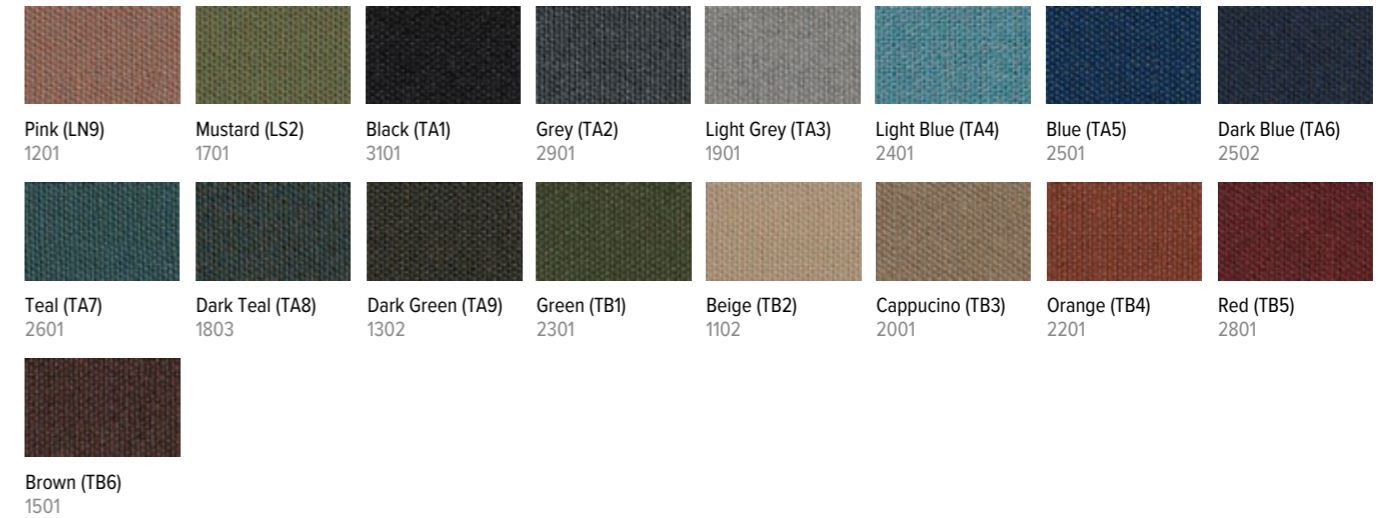

Camira Synergy* Wool

Code in grey is Camira reference



Velito / Velito Presto Wool

Code in grey is manufacturer reference



* Narbutas products are available in every colour from this fabric range. Fabrics and shades not featured above will have a longer production time. Colours are a printed representation and may vary to actual finish.

* Narbutas products are available in every colour from this fabric range. Fabrics and shades not featured above will have a longer production time. Colours are a printed representation and may vary to actual finish.

Leather Look

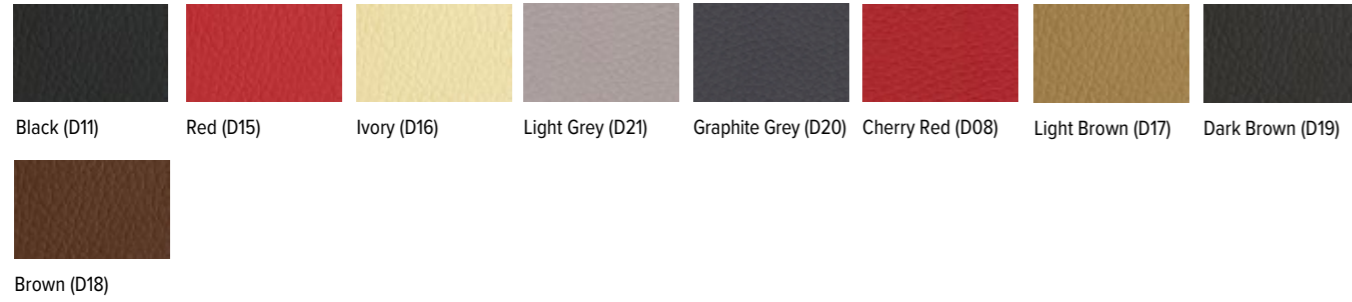

Spradling Valencia C5 Vinyl

Code in grey is Spradling reference



Real Leather



Fabric range comparison

	Fidivi Bondai	Berta	Camira Era	Camira Lucia	Camira Xtreme	Step / Step Malange	Camira Blazer Lite	Gabriel Cyber	Velito / Velito Presto	Camira Synergy	DNN Real Leather	RNN Leather Look	Valencia C5
	Polyester						Wool	Leather, etc					
Arcipelago		•				•			•				•
Cannie Stools			•		•	•		•	•	•			•
Choice Storage Cushion	•		•	•		•			•	•			
Danae			•		•	•		•	•	•	•	•	•
Eva II	•	•	•		•	•			•	•			•
Gama	•	•	•		•	•		•	•	•	•	•	
Giro			•			•		•	•	•	•	•	•
Havana	•		•	•	•	•		•		•			
Jazz Box Booth								•	•				
Jazz Chill Out		•	•		•	•		•	•	•	•	•	•
Luna			•		•	•			•	•	•	•	
Madrid	•		•	•	•	•		•		•			
Meg			•		•	•			•	•	•	•	
Modena	•		•	•	•	•		•		•			
Moon	•	•	•		•	•		•	•	•	•	•	
North Cape		•			•	•		•	•	•	•	•	•
Nova Pedestal Cushion	•		•	•					•	•			
Palermo	•		•	•	•	•		•		•			
Pixel									•	•	•	•	
Prague	•		•	•	•	•		•		•			
Seattle	•		•	•	•	•		•		•			
Silent Room		•				•			•	•			
Soft Rock		•	•		•	•		•	•	•		•	•
Twist & Sit			•			•		•	•	•		•	•
Tula			•			•		•	•	•		•	
Vegas			•		•	•			•	•	•	•	
Verona	•		•		•				•				
Wait Chairs	•	•	•		•	•			•	•		•	
Wind Task Chairs	•	•	•		•	•			•	•		•	•
Wind Meeting Chairs	•	•	•		•	•			•	•		•	•
Wobby	•	•	•		•	•		•	•	•	•	•	
Choice Storage Panels	•	•		•					•	•			
Easy Desktop Screens	•	•		•		•			•	•			
Formetiq® AL / AP / PV Screens			•	•	•		•			•			
Formetiq® FR Screens			•	•			•						
Formetiq® FS Screens							•						
Free Standing Screens		•		•					•	•			
Lined Drawer Inserts			•	•					•	•			
Modus Light Panels		•		•		•			•	•			
My Space Screens		•		•		•			•	•			
Nova Desktop Screens	•	•		•		•			•	•			
Optima Desktop Screens	•	•		•		•			•	•			
Round Fabric Panels		•		•					•	•			
Top 530 / Desk 760 Screens		•		•		•			•	•			
Uni Storage Panels	•	•		•					•	•			

* For desks with HPL top available only in-between screens for 2 and 4-desk benches:
Fabric: DNK142, DNK162, DNK182, DNK143, DNK163, DNK183. Plexiglas: DNK151, DNK171, DNK189.

Desking / screen compatibility

	Air	Alto Desks	Alto Bench	Motion Desks	Motion Bench	Nova 'U' leg	Nova 'A' leg	Nova 'O' leg	Nova U Sliding Top	Nova Wood MFC Desks	Nova Wood MFC Bench	Nova Wood HPL	Optima C	Optima Plus	Round Bench	Round Rect. Desks
Formetiq Fabric Screens		•		•		•	•	•	•	•	•	•	•	•		
Formetiq Perspex® Screens		•		•		•	•	•	•	•	•	•	•	•		
Nova Fabric Screens*						•	•	•		•	•				•	•
Nova Fabric Slide DNK14E / DNK16E / DNK14F / DNK16F / DNK14G / DNK16G									•						•	•
Nova Plexiglas Screens*						•	•	•		•	•					
ATK070 / ATK080						•	•	•		•	•					
ATP120 / 140 / 160 / 180						•	•	•		•	•					
ATV120 / 140 / 160 / 180						•	•	•		•	•	•				
ATS070 / ATS080 / ATL100 / ATR100						•	•	•		•	•					
ATP121 / 141 / 161 / 181		•				•	•	•					•	•		
ATP122 / 142 / 162 / 182		•														
ADK080 / ADK081					•	•	•	•		•	•				•	•
ADK100 / ADK101					•	•	•	•		•	•					•
ADK102 / ADK103		•			•	•	•	•		•	•					•
ADP120 / 140 / 160 / 180					•	•	•	•		•	•					•
ADP121 / 141 / 161 / 181		•			•	•	•	•		•	•		•	•		•
Easy Screens		•				•	•	•		•						
Round PET Screens		•	•	•	•	•	•	•	•	•	•	•	•	•	•	•
Optima Fabric Screens													•	•		
APK120 / 140 / 160 / 180		•		•			•			•						
APK141 / 161 / 181 / 142 / 162 / 182 / 143 / 144 / 163 / 164 / 183 / 184					•											

* For desks with HPL top available only in-between screens for 2 and 4-desk benches:
Fabric: DNK142, DNK162, DNK182, DNK143, DNK163, DNK183. Plexiglas: DNK151, DNK171, DNK189.

47 Gee Street
Clerkenwell
EC1V 3RS

Contact our showroom
manager, Matthew Fleck,
to arrange your visit:
+44 (0)20 3620 5151



Visit our London showroom

Get hands on with our products at our
London showroom in the heart of Clerkenwell

Experience our virtual showroom tour arrowgroup.com/showroom

formetiq®



METALICON®

narbutas

ARROW
GROUP

Compass House, Waveney Drive, Lowestoft, NR33 0TP
+44 (0)1502 533 433 | sales@arrowgroup.com
arrowgroup.com